



www.vdo.com

Scheiben- und Scheinwerfer- Reinigungssysteme V. 5.1



The Company

Alongside our many specialised solutions for automotive manufacturers, we also offer comprehensive solutions and services for the aftermarket. Spare parts of matching quality, supplied with the experience and proven expertise of an OEM supplier are a particular strength. Our comprehensive range of spare parts of matching quality is readily available and is synonymous with a perfect fit, simple installation and consistently reliable quality, offering significant advantages for distributors, workshops and consumers alike.

Das Unternehmen

Neben unseren speziellen und vielfältigen Lösungen für Automobilhersteller bieten wir umfassende Lösungen und Serviceaktivitäten für den Aftermarket. Hierzu zählen insbesondere qualitativ gleichwertige Ersatzteile, die wir mit dem Wissen und der langjährigen Kompetenz eines Erstausrüsters anbieten. Das umfassende und zeitnah verfügbare Leistungsspektrum an Ersatzteilen steht für Passgenauigkeit, einen einfachen Einbau sowie gleichbleibende Qualität. So bieten qualitativ gleichwertige Ersatzteile Großhändlern, Werkstätten und Endkunden gleichermaßen deutliche Vorteile.

L'entreprise

Parallèlement à nos solutions particulières et multiples pour les constructeurs automobile nous offrons des solutions et des activités de service étendues pour l'Aftermarket (marché de pièces de rechange et d'accessoires). En font partie en particulier les pièces détachées qualitativement équivalentes que nous proposons avec le savoir et la compétence de longue durée d'un premier équipementier de série. La gamme étendue de fournitures, disponibles à brève échéance, de pièces détachées représente la précision de l'assemblage, un montage simple ainsi qu'une qualité constante. Ainsi les pièces détachées qualitativement équivalentes offrent des avantages nets de la même manière aux grossistes, aux garages et aux clients finaux.



Nuestra empresa

Además de las soluciones especiales y variadas que producimos para fabricantes de automóviles, ofrecemos numerosas soluciones y actividades de servicio para el mercado postventa. Entre éstas destacan en particular los recambios de calidad equivalente, que ofrecemos al mercado con los conocimientos y el nivel de competencia, forjados durante muchos años, de un fabricante de primeros equipos. Nuestro amplísimo espectro de recambios, disponibles al poco tiempo de aparecer en cada modelo de automóvil, se caracterizan por su precisión de ajuste, su montaje sencillo y su calidad constante. Por ello, los recambios de calidad equivalente suponen por igual claras ventajas para mayoristas, talleres y clientes finales.



La società

Oltre a numerose soluzioni specializzate per i produttori di automobili offriamo soluzioni e servizi ad ampio spettro per il settore aftermarket (pezzi di ricambio e accessori). Tra questi rientrano in particolare pezzi di ricambio qualitativamente equivalenti che offriamo con il know-how e l'esperienza pluriennale di un fornitore OEM. La vasta gamma di pezzi di ricambio rapidamente disponibili rappresenta una soluzione ottimale, facilmente installabile e di qualità costante. I pezzi di ricambio qualitativamente equivalenti offrono pertanto ai distributori, alle officine e ai clienti finali notevoli vantaggi.

Компания

Помимо узкоспециальных и широкопрофильных решений для автопроизводителей мы готовы предложить комплексные решения, включая набор сервисных операций, для послепродажного обслуживания автомобилей. В частности, по качеству равноценные оригинальным запасные части, которые мы, как предприятие-изготовитель, предлагаем партнерам на базе наших знаний и многолетнего опыта. С учетом широкого спектра услуг и возможности поставок в кратчайшие сроки гарантирована точность изготовления изделий, простой монтаж и стабильное качество производства. Поэтому приобретая по качеству равноценные оригинальным запасные части у нас, оптовые покупатели, промышленные предприятия и конечные пользователи в одинаковой степени получают очевидные преимущества.

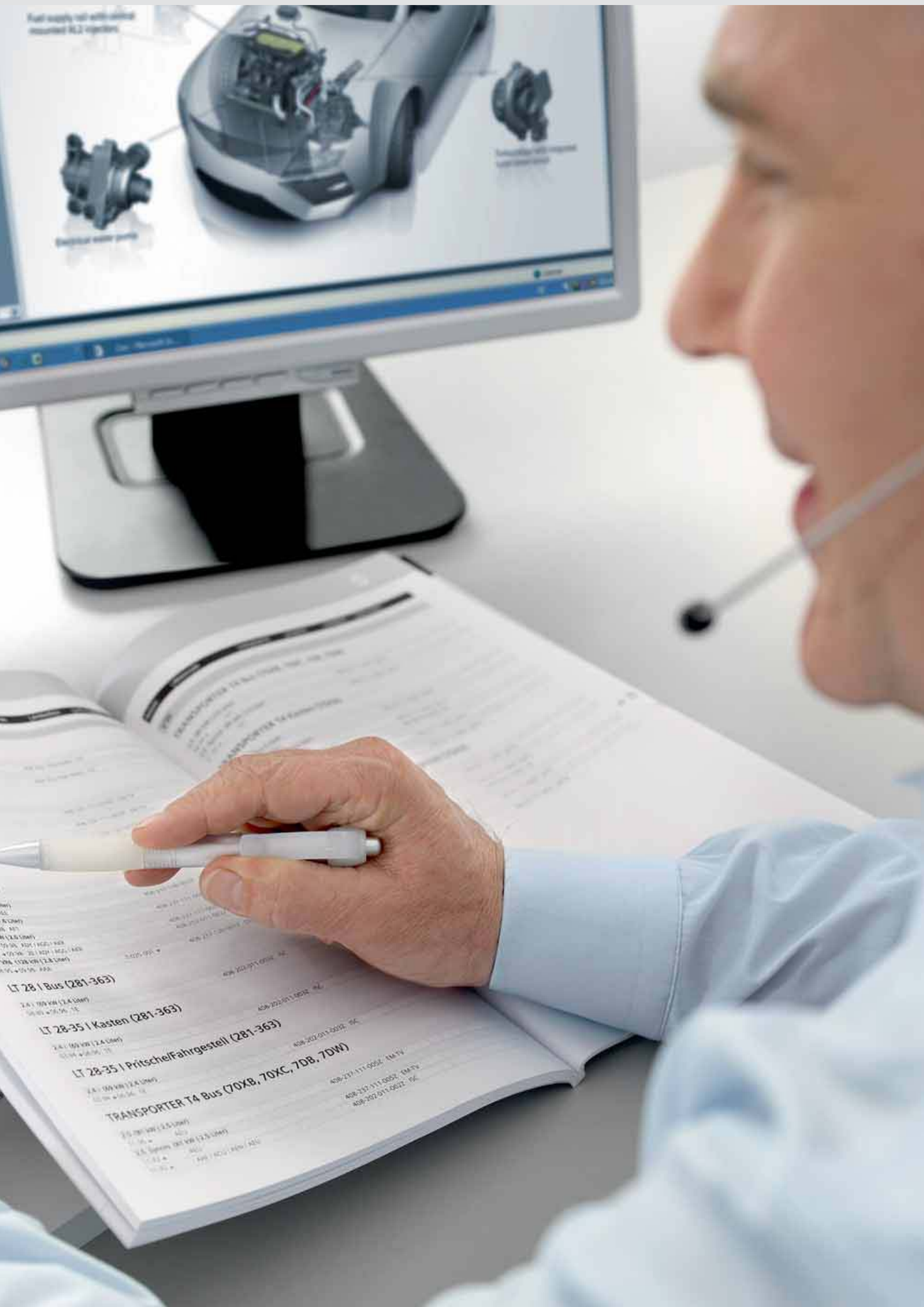

Fuel supply with electronic controlled H.D. injectors

Electrical water pump

Turbocharger with integrated wastegate

TRANSPORTER T4 Bus (281-363)

TRANSPORTER T4 Kasten (281-363)

TRANSPORTER T4 Pritsche/Fahrgestell (281-363)

TRANSPORTER T4 Bus (70XB, 70XC, 70B, 70W)

Inhaltsverzeichnis

	Das Unternehmen	2
	Produktübersicht	6
	Produkt Applikationen (PKW)	34
	Produkt Applikationen (LKW)	415
	Referenzliste	445
	Legende	500



Scheiben- und Scheinwerfer-Reinigungssysteme



**Scheiben-Reinigungspumpen,
Mono – Zentrifugalpumpen**

Mono-Pumpen haben einen Förderausgang und versorgen Front- oder Heckscheibe mit Wasser. Zur Versorgung von Front- und Heckscheibe sind zwei Pumpen erforderlich (12 V oder 24 V).



**Scheiben-Reinigungspumpen,
Dual – Zentrifugalpumpen**

Dual-Pumpen haben zwei Förderrichtungen. Mit nur einer Pumpe wird je nach Drehrichtung des Pumpenmotors Reinigungswasser über den einen oder anderen Förderausgang zur Front- oder Heckscheibe gepumpt (12 V oder 24 V).



**Scheiben-Reinigungspumpen,
Mono – Zahnradpumpen**

Selbstansaugende Mono-Pumpen
(12 V oder 24 V).



Scheinwerfer-Reinigungspumpen

Scheinwerfer-Reinigungspumpen dienen der Reinigung der Streuscheiben. Sie versorgen die Streuscheiben-Reinigungsdüsen mit der dafür notwendigen Wassermenge und gewährleisten den erforderlichen hohen Wasserdruck (12 V).



Reinigungsdüsen

Reinigungsdüsen dienen der Wasser- aufbringung zur Reinigung der Front-/ Heckscheiben und der Streuscheiben (Scheinwerfer). Die Düsen sind teilweise in beheizbarer Ausführung (12 V) erhältlich. Zum Teil sind die Düsen mit einem Rückschlagventil ausgestattet, das den Wasserrückfluss verhindert.

Kugeldüsen

Bei den Kugeldüsen wird zwischen Einstrahldüsen (1) und Mehrstrahldüsen (2/4) unterschieden. Das Wasser wird zielgerichtet mit der entsprechenden Strahlzahl auf die Scheibe aufgebracht.



Zubehör

Niveauschalter

Niveauschalter werden für die Restmengenwarnung genutzt. Beim Unterschreiten eines definierten Wasserstandes wird über die Betätigung eines Reedkontaktes eine Kontroll-Leuchte geschaltet.

Verbindungsstücke

Winkel-, T-, I- und Y-Stücke verbinden verschiedene Leitungssegmente.

Ventile

Rückschlagventile verhindern das Zurückfließen von Reinigungsflüssigkeit. Das verkürzt die Ansprechzeit der Reinigungsanlage deutlich. Rückschlagventile können auch bereits im Düsengehäuse integriert sein.

Dichtungen

Zwischen Pumpenansaugstutzen und Behälter werden Dichtungen eingebaut. In Verbindung mit einem Filterschutz schützen sie die Pumpen vor Verunreinigungen und damit vor Beschädigungen.

Düsennadel

Düsennadeln dienen der Justage von Kugeldüsen.

Adapter

Für den 1:1-Anschluss bestimmter Pumpen in einigen Fahrzeugen sind Adapter erforderlich (siehe Kapitel „Produktverwendung“).

Reinigungsflüssigkeits-Behälter

Die Vorratsbehälter speichern die Reinigungsflüssigkeit.



246-061-009-002D

Behälter

_ Inhalt [L]: 1,0



246-061-022-001C

Behälter

_ Inhalt [L]: 2,0



246-063-004-001G

Ventil

_ Ventilart: Rückschlagventil



246-063-012-001G

Ventil

_ Ventilart: Rückschlagventil

Fahrzeugmodelle dienen nur der allgemeinen Information und nicht als ausführliche Anleitung zur Verwendung der Produkte.



246-063-013-001D
Ventil
_ Ventilart: Rückschlagventil



246-063-016-001G
Ventil
_ Ventilart: Rückschlagventil



246-063-016-003G
Ventil
_ Ventilart: Rückschlagventil



246-068-003-001G
Düse
_ Anzahl der Strahlen: 1

Fahrzeugmodelle dienen nur der allgemeinen Information und nicht als ausführliche Anleitung zur Verwendung der Produkte.



246-068-013-004D

Düse

_ Anzahl der Strahlen: 1



246-069-026-001G

Düse

_ Anzahl der Strahlen: 2

MERCEDES-BENZ

Stufenheck (W123); KOMBI Kombi (S123); COUPE (C123);
S-KLASSE Stufenheck (W108, W109); /8 (W115); /8 (W114)



246-069-029-004G

Düse

_ Anzahl der Strahlen: 2



246-069-050-005D

Düse

_ Anzahl der Strahlen: 4

Fahrzeugmodelle dienen nur der allgemeinen Information und nicht als ausführliche Anleitung zur Verwendung der Produkte.



246-069-056-001Z

Düse

_ Anzahl der Strahlen: 2

SEAT

CORDOBA (6K2/C2); CORDOBA Vario (6K5); IBIZA II (6K1); INCA (6K9);
LEON (1M1); TOLEDO II (1M2)

VW

CADDY I (14); CADDY II Kasten (9K9A); CORRADO (53I); GOLF I Cabriolet (155);
GOLF III (1H1); GOLF III Variant (1H5); GOLF III Cabriolet (1E7);
GOLF IV Cabriolet (1E7); PASSAT (3A2, 35I); PASSAT Variant (3A5, 35I);
POLO (6N1); POLO Kasten (6NF); POLO CLASSIC (6KV2); POLO Variant (6KV5);
POLO (6N2); VENTO (1H2); TRANSPORTER T4 Bus (70XB, 70XC, 7DB, 7DW); TRANSPORTER T4 Pritsche/Fahrgestell (70XD)



246-069-059-001Z

Düse

_ Anzahl der Strahlen: 2

BMW

3 (E36); 3 Compact (E36); 3 Cabriolet (E36); 3 Touring (E36); 5 (E34); 7 (E32)



246-075-010-001C

Mono - Zahnradpumpe

_ Spannung [V]: 24

_ Stecker Nr.: 1

_ Halter Nr.: A

MAN

G; M 90; M 2000 L

Fahrzeugmodelle dienen nur der allgemeinen Information und nicht als ausführliche Anleitung zur Verwendung der Produkte.



246-075-015-001C
Mono - Zahnradpumpe
_ Spannung [V]: 12
_ Stecker Nr.: 1
_ Halter Nr.: A

PORSCHE
911; 911 Targa; 914; 928



246-075-017-002C
Mono - Zahnradpumpe
_ Spannung [V]: 12
_ Stecker Nr.: 4
_ Halter Nr.: C

MERCEDES-BENZ
A-KLASSE (W168); A-KLASSE (W169); S-KLASSE Stufenheck (W108, W109); S-KLASSE (W116); G-KLASSE Geländewagen offen (W463); HECKFLOSSE (W111); COUPE (W111); CABRIOLET (W111); /8 (W115); /8 (W114); /8 Coupe (W114); PAGODE (W113); VITO Bus (638); VITO Kasten (638); VITO Bus (W639); VITO Kasten (W639); T1 Bus (602); T1 Kasten (602); T1 Pritsche/Fahrgestell (602); SPRINTER 3-t Bus (903); SPRINTER 3-t Kasten (903); SPRINTER 3-t Pritsche/Fahrgestell (903)



246-075-021-006C
Mono - Zahnradpumpe
_ Spannung [V]: 12
_ Stecker Nr.: 1
_ Halter Nr.: B

ALPINA
B7 Coupe (E24)

AUDI
50 (86); 80 (80, 82, B1); 100 Avant (43, C2); 100 (44, 44Q, C3);
100 Avant (44, 44Q, C3); 200 (44, 44Q); 200 Avant (44, 44Q); NSU RO 80

PORSCHE
924; 944; 944 Cabriolet

Fahrzeugmodelle dienen nur der allgemeinen Information und nicht als ausführliche Anleitung zur Verwendung der Produkte.



246-075-021-006C

Mono - Zahnradpumpe

- _ Spannung [V]: 12
- _ Stecker Nr.: 1
- _ Halter Nr.: B

VW

DERBY (86); GOLF I (17); JETTA I (16); KAEFER; KARMANN GHIA Cabriolet (14, 34); K 70 (48); PASSAT (32); PASSAT Variant (33); POLO (86); SCIROCCO (53); 1500,1600 Variant (36); LT 28 I Bus (281-363); LT 28-35 I Kasten (281-363); LT 28-35 I Pritsche/Fahrgestell (281-363); LT 40-55 I Pritsche/Fahrgestell (293-909); TRANSPORTER T2 Bus; TRANSPORTER T2 Pritsche/Fahrgestell



246-075-021-007C

Mono - Zahnradpumpe

- _ Spannung [V]: 12
- _ Stecker Nr.: 1
- _ Halter Nr.: C

MERCEDES-BENZ

S-KLASSE (W116); G-KLASSE (W460); G-KLASSE Geländewagen offen (W463); /8 (W115); /8 (W114); /8 Coupe (W114); VITO Bus (638); VITO Kasten (638); VITO Bus (W639); VITO Kasten (W639); T1 Bus (601); T1 Kasten (601); T1 Bus (602); T1 Kasten (602); T1 Pritsche/Fahrgestell (602); SPRINTER 3-t Bus (903); SPRINTER 3-t Kasten (903); SPRINTER 3-t Pritsche/Fahrgestell (903)



246-075-023-004C

Mono - Zahnradpumpe

- _ Spannung [V]: 12
- _ Stecker Nr.: 1
- _ Halter Nr.: D

BMW

5 (E12)

VOLVO

340-360 (343, 345)

Fahrzeugmodelle dienen nur der allgemeinen Information und nicht als ausführliche Anleitung zur Verwendung der Produkte.



246-075-024-002C

Mono - Zahnradpumpe

- _ Spannung [V]: 24
- _ Spannung [V]: 24
- _ Stecker Nr.: 1; _ Stecker Nr.: 1
- _ Halter Nr.: C; _ Halter Nr.: C

MERCEDES-BENZ

S-KLASSE (W220); SL (R230); G-KLASSE (W460); G-KLASSE (W461);
G-KLASSE (W463); G-KLASSE Geländewagen offen (W463); HECKFLOSSE (W110);
VITO Bus (638); VITO Kasten (638); T1 Kasten (602); NG; T2/L



246-075-024-005C

Mono - Zahnradpumpe

- _ Spannung [V]: 24
- _ Stecker Nr.: 1
- _ Halter Nr.: D



246-075-040-020C

Mono - Zahnradpumpe

- _ Spannung [V]: 24
- _ Stecker Nr.: 1
- _ Halter Nr.: F

VOLVO

F 10



246-075-042-001C

Mono - Zahnradpumpe

- _ Spannung [V]: 12
- _ Stecker Nr.: 1

BMW

7 (E23)

Fahrzeugmodelle dienen nur der allgemeinen Information und nicht als ausführliche Anleitung zur Verwendung der Produkte.



246-075-042-001C
Mono - Zahnradpumpe
_ Spannung [V]: 12
_ Stecker Nr.: 1

PORSCHE
911 (964); 924; 928; 944

VOLVO
340-360 (343, 345)



246-075-044-001C
Mono - Zahnradpumpe
_ Spannung [V]: 12
_ Stecker Nr.: 2

VOLVO
740 (744); 740 Kombi (745); 760 (704, 764); 760 Kombi (704, 765); 780;
850 (LS); 850 Kombi (LW); 940 (944); 940 Kombi (945); 940 II (944);
940 II Kombi (945); 960 (964); 960 Kombi (965); 960 II (964); 960 II Kombi (965)



246-075-044-002A
Mono - Zahnradpumpe
_ Spannung [V]: 12
_ Stecker Nr.: 2

VOLVO
S70; V70 I Kombi; 740 Kombi (745); 760 Kombi (704, 765); 850 Kombi (LW);
940 Kombi (945); 940 II Kombi (945); 960 Kombi (965); 960 II Kombi (965)



246-075-044-003A
Mono - Zahnradpumpe
_ Spannung [V]: 24
_ Stecker Nr.: 2

SCANIA
Serie 3; Serie 4

Fahrzeugmodelle dienen nur der allgemeinen Information und nicht als ausführliche Anleitung zur Verwendung der Produkte.



246-075-050-007C
Mono - Zahnradpumpe
_ Spannung [V]: 24
_ Stecker Nr.: 1



246-075-051-003C
Mono - Zahnradpumpe
_ Spannung [V]: 12
_ Stecker Nr.: 2
_ Halter Nr.: F

VOLVO
140 (142, 144); 240 (P242, P244); 240 Kombi (P245); 260 (P262, P264);
260 Kombi (P265)



246-075-051-007C
Mono - Zahnradpumpe
_ Spannung [V]: 24
_ Stecker Nr.: 2
_ Halter Nr.: F

VOLVO
F 10; F 12; F 16



246-080-003-006D
Düse
_ Spannung [V]: 12
_ Anzahl der Strahlen: 2
_ Ausrüstung: Beheizbar

MERCEDES-BENZ
S-KLASSE (W126)

Fahrzeugmodelle dienen nur der allgemeinen Information und nicht als ausführliche Anleitung zur Verwendung der Produkte.



246-080-010-002Z

Düse

- _ Spannung [V]: 12
- _ Anzahl der Strahlen: 2
- _ Ausrüstung: Beheizbar

SEAT

CORDOBA (6K2/C2); IBIZA II (6K1); INCA (6K9); LEON (1M1); TOLEDO I (1L); TOLEDO II (1M2)

VW

CADDY I (14); CADDY II Kasten (9K9A); CORRADO (53I); GOLF I Cabriolet (155); GOLF III (1H1); GOLF III Variant (1H5); GOLF III Cabriolet (1E7); PASSAT (3A2, 35I); PASSAT Variant (3A5, 35I); POLO (6N1); POLO CLASSIC (6KV2); VENTO (1H2); TRANSPORTER T4 Bus (70XB, 70XC, 7DB, 7DW); TRANSPORTER T4 Kasten (70XA); TRANSPORTER T4 Pritsche/Fahrgestell (70XD)



246-080-013-001Z

Düse

- _ Spannung [V]: 12
- _ Anzahl der Strahlen: 2
- _ Ausrüstung: Beheizbar

BMW

3 (E30); 3 Touring (E30); 5 (E34); 6 (E24); 7 (E32)



246-080-013-003Z

Düse

- _ Spannung [V]: 12
- _ Anzahl der Strahlen: 2
- _ Ausrüstung: Beheizbar

BMW

3 (E36); 3 Compact (E36); 3 Touring (E36); 5 (E34); 7 (E32); Z3

Fahrzeugmodelle dienen nur der allgemeinen Information und nicht als ausführliche Anleitung zur Verwendung der Produkte.



246-082-001-001C
Mono - Zentrifugalpumpe
_ Spannung [V]: 12
_ Stecker Nr.: 2

SAAB

900 I Combi Coupe; 900 I; 900 I Cabriolet; 9000 Schrägheck; 9000



246-082-001-002C
Mono - Zentrifugalpumpe
_ Spannung [V]: 24
_ Stecker Nr.: 2



246-082-005-002C
Mono - Zentrifugalpumpe
_ Spannung [V]: 12
_ Stecker Nr.: 4

MERCEDES-BENZ

190 (W201); Stufenheck (W123); KOMBI Kombi (S123); Stufenheck (W124);
KOMBI Kombi (S124); COUPE (C124); CABRIOLET (A124); E-KLASSE (W124);
E-KLASSE Kombi (S124); E-KLASSE Coupe (C124); E-KLASSE Cabriolet (A124);
S-KLASSE (W126); S-KLASSE Coupe (C126); S-KLASSE (W140); SL (R107)



246-082-008-012C
Mono - Zentrifugalpumpe
_ Spannung [V]: 24
_ Stecker Nr.: 1

MAN

G

MERCEDES-BENZ

LK/LN2; LP; MK; T2/LN1; VARIO

Fahrzeugmodelle dienen nur der allgemeinen Information und nicht als ausführliche Anleitung zur Verwendung der Produkte.

**246-082-008-013P**

Mono - Zentrifugalpumpe

- _ Spannung [V]: 12
- _ Stecker Nr.: 4

MERCEDES-BENZ

190 (W201); C-KLASSE (W202); C-KLASSE Kombi (S202); Stufenheck (W123); KOMBI Kombi (S123); COUPE (C123); Stufenheck (W124); KOMBI Kombi (S124); COUPE (C124); CABRIOLET (A124); E-KLASSE (W124); E-KLASSE Kombi (S124); E-KLASSE Coupe (C124); E-KLASSE Cabriolet (A124); E-KLASSE (W210); S-KLASSE (W126); S-KLASSE Coupe (C126); S-KLASSE (W140); S-KLASSE Coupe (C140); S-KLASSE Coupe (C215); SL Coupe (C107); SL (R107); SL (R129); /8 (W115); /8 (W114)

**246-082-008-014C**

Mono - Zentrifugalpumpe

- _ Spannung [V]: 12
- _ Stecker Nr.: 1

AUDI

A6 (4A, C4); A6 Avant (4A, C4); A6 Avant (4B, C5); V8 (44_, 4C_); 80 (80, 82, B1); 80 (81, 85, B2); COUPE (81, 85); QUATTRO (85); 80 (89, 89Q, 8A, B3); COUPE (89, 8B); CABRIOLET (8G7, B4); 80 Avant (8C, B4); 90 (81, 85, B2); 90 (89, 89Q, 8A, B3); 100 (C1); 100 (43, C2); 100 Avant (43, C2); 100 (44, 44Q, C3); 100 Avant (44, 44Q, C3); 100 (4A, C4); 100 Avant (4A, C4); 200 (43); 200 (44, 44Q); 200 Avant (44, 44Q)

FORD

TRANSIT Bus (T_); TRANSIT Kasten (T_); TRANSIT Kasten (E_)

LADA

NIVA (2121); SAMARA (2108, 2109); SAMARA FORMA (21099)

MERCEDES-BENZ

G-KLASSE (W460); V-KLASSE (638/2); VITO Bus (638); VITO Kasten (638); T1 Bus (601); T1 Kasten (601); T1 Pritsche/Fahrgestell (601); SPRINTER 2-t Bus (901, 902); SPRINTER 2-t Kasten (901, 902); SPRINTER 2-t Pritsche/Fahrgestell (901, 902); SPRINTER 3-t Bus (903); SPRINTER 3-t Kasten (903); SPRINTER 3-t Pritsche/Fahrgestell (903); SPRINTER 4-t Bus (904); SPRINTER 4-t Kasten (904); SPRINTER 4-t Pritsche/Fahrgestell (904)

Fahrzeugmodelle dienen nur der allgemeinen Information und nicht als ausführliche Anleitung zur Verwendung der Produkte.



246-082-008-014C

Mono - Zentrifugalpumpe

_ Spannung [V]: 12

_ Stecker Nr.: 1

OPEL

ASCONA A (81_, 86_, 87_, 88_); ASCONA B (81_, 86_, 87_, 88_);
ASCONA C CC (84_, 89_); ASCONA C (81_, 86_, 87_, 88_); ASTRA F (56_, 57_);
COMMODORE C (14_, 19_); COMMODORE C Caravan (61);
CORSA A CC (93_, 94_, 98_, 99_); CORSA A TR (91_, 92_, 96_, 97_);
CORSA A Kasten; KADETT C City; KADETT C; KADETT C Caravan; KADETT C Coupe;
KADETT D (31_-34_, 41_-44_); KADETT D Caravan (35_, 36_, 45_, 46_);
KADETT E CC (33_, 34_, 43_, 44_); KADETT E (39_, 49_);
KADETT E Caravan (35_, 36_, 45_, 46_); KADETT E Cabriolet (43B_);
KADETT E Kasten (37_, 47_); KADETT E Combo (38_, 48_); MANTA B (58_, 59_);
MANTA B CC (53_, 55_); MONZA A (22_); OMEGA A (16_, 17_, 19_);
OMEGA A Caravan (66_, 67_); OMEGA B (25_, 26_, 27_); REKORD D;
REKORD D Caravan; REKORD E (17_-19_, 11_, 14_, 16_);
REKORD E Caravan (61_, 66_, 67_); SENATOR A (29_); SENATOR B (29_);
VECTRA A (86_, 87_)

SAAB

90; 900 I Combi Coupe; 900 I

SEAT

TOLEDO I (1L)

VAUXHALL

ASTRA Mk III; CARLTON Mk III; CARLTON Mk III Estate; CAVALIER Mk II CC;
CAVALIER Mk II; CAVALIER Mk II Estate; CAVALIER Mk II Convertible;
CAVALIER Mk III; NOVA CC; NOVA; OMEGA; SENATOR Mk II

Fahrzeugmodelle dienen nur der allgemeinen Information und nicht als ausführliche Anleitung zur Verwendung der Produkte.

**246-082-008-014C**

Mono - Zentrifugalpumpe

_ Spannung [V]: 12

_ Stecker Nr.: 1

VW

CADDY I (14); CORRADO (53I); DERBY (86); DERBY (86C, 80); GOLF I (17);
 GOLF I Cabriolet (155); GOLF II (19E, 1G1); ILTIS (183); JETTA I (16);
 JETTA II (19E, 1G2); PASSAT (32); PASSAT Variant (33); PASSAT (32B);
 PASSAT Stufenheck (32B); PASSAT Variant (32B); PASSAT (3A2, 35I); POLO (86);
 POLO (86C, 80); POLO CLASSIC (86C, 80); POLO Coupe (86C, 80);
 POLO Kasten (86CF); POLO (6N1); POLO CLASSIC (6KV2); SANTANA (32B); SCIROCCO
 (53); SCIROCCO (53B); LT 28 I Bus (281-363); LT 28-35 I Kasten (281-363);
 LT 40-55 I Kasten (291-512); LT 28-35 I Pritsche/Fahrgestell (281-363);
 LT 28-35 II Bus (2DM); LT 28-46 II Kasten (2DX0AE);
 LT 28-46 II Pritsche/Fahrgestell (2DX0FE); TRANSPORTER T3 Bus;
 TRANSPORTER T3 Kasten; TRANSPORTER T3 Pritsche/Fahrgestell;
 TRANSPORTER T4 Bus (70XB, 70XC, 7DB, 7DW); TRANSPORTER T4 Kasten (70XA);
 TRANSPORTER T4 Pritsche/Fahrgestell (70XD)

**246-082-008-021G**

Mono - Zentrifugalpumpe

_ Spannung [V]: 12

_ Stecker Nr.: 6

OPEL

ASTRA G Coupe (F07_); CORSA B (73_, 78_, 79_, F35_); CORSA C (F08, F68);
 OMEGA B (25_, 26_, 27_); TIGRA (95_); VECTRA B (36_); VECTRA C GTS; VECTRA C;
 ZAFIRA (F75_)

SEAT

CORDOBA (6K2/C2); CORDOBA Vario (6K5); IBIZA II (6K1); INCA (6K9)

VAUXHALL

OMEGA; VECTRA CC; VECTRA

VW

CADDY II Kombi (9K9B); CADDY II Kasten (9K9A); GOLF III Variant (1H5);
 GOLF III Cabriolet (1E7); GOLF IV Variant (1J5); GOLF IV Cabriolet (1E7); PAS-
 SAT (3A2, 35I); PASSAT (3B2); POLO CLASSIC (6KV2); VENTO (1H2)

Fahrzeugmodelle dienen nur der allgemeinen Information und nicht als ausführliche Anleitung zur Verwendung der Produkte.

**246-082-008-025G**

Mono - Zentrifugalpumpe

_ Spannung [V]: 12

_ Stecker Nr.: 3

AUDI

A2 (8Z0); A4 (8D2, B5); A4 Avant (8D5, B5); A4 (8E2, B6); A4 Avant (8E5, B6);
A4 Cabriolet (8H7); A4 (8EC); A6 (4B, C5); A6 (4F2); A8 (4E_); TT (8N3);
TT Roadster (8N9)

BMW

1 (E87); 3 (E36); 3 Compact (E36); 3 Coupe (E36); 3 Cabriolet (E36);
3 Touring (E36); 3 (E46); 3 Compact (E46); 3 Coupe (E46); 3 Cabriolet (E46);
3 Touring (E46); 3 (E90); 5 (E39); 5 Touring (E39); 5 (E60); 5 Touring (E61);
7 (E38); 7 (E65, E66); X3 (E83); X5 (E53); Z3; Z3 Coupe; Z4 (E85); Z8

MERCEDES-BENZ

C-KLASSE (W202); C-KLASSE Kombi (S202); C-KLASSE (W203);
C-KLASSE Kombi (S203); CLK (C208); CLK Cabriolet (A208); CLK (C209); E-KLAS-
SE (W210); E-KLASSE Kombi (S210); E-KLASSE (W211); E-KLASSE Kombi (S211);
S-KLASSE (W140); S-KLASSE Coupe (C140); S-KLASSE (W220);
S-KLASSE Coupe (C215); CLS (C219); SL (R129); SL (R230); SLK (R170);
SLK (R171); M-KLASSE (W163); G-KLASSE (W461); G-KLASSE (W463);
G-KLASSE Geländewagen offen (W463); 170 (W170); VIANO (W639);
VITO Bus (W639); VITO Kasten (W639)

PORSCHE

911 (964); 911 Cabriolet (964); 911 (993); 911 Targa (993); 911 Cabriolet (993);
911 (996); 911 Cabriolet (996); 928; BOXSTER (986)

SEAT

CORDOBA Vario (6K5); CORDOBA (6L2); INCA (6K9); LEON (1M1); TOLEDO II (1M2)

SKODA

FABIA (6Y2); FABIA Stufenheck (6Y3); OCTAVIA (1U2); OCTAVIA Combi (1U5);
OCTAVIA (1Z3); SUPERB (3U4)

VW

BORA (1J2); BORA Kombi (1J6); CADDY II Kombi (9K9B); CADDY II Kasten (9K9A);
CADDY III Kasten (2KA); FOX (5Z1); GOLF IV (1J1); GOLF IV Cabriolet (1E7);
GOLF V (1K1); NEW BEETLE (9C1, 1C1); NEW BEETLE Cabriolet (1Y7);
PASSAT (3B2); PASSAT (3B3); PASSAT (3C2); PHAETON (3D2);
POLO CLASSIC (6KV2); POLO (9N_); POLO Stufenheck;
TRANSPORTER T5 Bus (7HB, 7HJ); TRANSPORTER T5 Kasten (7HA, 7HH)

Fahrzeugmodelle dienen nur der allgemeinen Information und nicht als ausführliche Anleitung zur Verwendung der Produkte.

**246-083-001-004C**

Dual - Zentrifugalpumpe

_ Spannung [V]: 12

_ Stecker Nr.: 1

ALFA ROMEO

145 (930); 146 (930); 147 (937); 156 (932); 156 Sportwagon (932)

FIATBRAVA (182); BRAVO (182); COUPE (FA/175); DOBLO (223); DOBLO Cargo (223);
IDEA; MAREA (185); MAREA Weekend (185); MULTIPLA (186); PALIO (178BX);
PALIO Weekend (178DX); PUNTO (176); PUNTO Cabriolet (176C);
PUNTO Van (176L); PUNTO (188); PUNTO Van (188AX); STILO (192);
STILO Multi Wagon (192); TEMPRA (159); TEMPRA S.W. (159); TIPO (160)**LANCIA**DEDRA (835); DEDRA SW (835); DELTA II (836); LYBRA (839AX);
LYBRA SW (839BX); MUSA; Y (840A); YPSILON**OPEL**ASTRA F CC (53_, 54_, 58_, 59_); ASTRA F (56_, 57_); ASTRA F Caravan (51_, 52_);
ASTRA F Cabriolet (53_B); CALIBRA A (85_); COMBO (71_);
CORSA A CC (93_, 94_, 98_, 99_); CORSA A TR (91_, 92_, 96_, 97_);
CORSA A Kasten; CORSA B (73_, 78_, 79_, F35_);
KADETT E CC (33_, 34_, 43_, 44_); KADETT E (39_, 49_);
KADETT E Cabriolet (43B_); OMEGA B Caravan (21_, 22_, 23_); TIGRA (95_); VEC-
TRA A CC (88_, 89_)**VAUXHALL**ASTRA Mk III CC; ASTRA Mk III; ASTRA Mk III Estate; CALIBRA; CAVALIER Mk III CC;
CAVALIER Mk III; COMBO; CORSA; OMEGA Estate; TIGRA**246-083-001-006C**

Dual - Zentrifugalpumpe

_ Spannung [V]: 24

_ Stecker Nr.: 1

MAN

F 2000; L 2000

Fahrzeugmodelle dienen nur der allgemeinen Information und nicht als ausführliche Anleitung zur Verwendung der Produkte.



246-083-002-006G

Dual - Zentrifugalpumpe

_ Spannung [V]: 12

_ Stecker Nr.: 1

VW

CORRADO (53I); PASSAT Variant (32B); PASSAT Variant (3A5, 35I); POLO (86C, 80); POLO Coupe (86C, 80); TRANSPORTER T4 Bus (70XB, 70XC, 7DB, 7DW)



246-083-002-014G

Dual - Zentrifugalpumpe

_ Spannung [V]: 12

_ Stecker Nr.: 6

FORD

GALAXY (WGR)

OPEL

AGILA (H00); ASTRA F Van (55_); ASTRA F CLASSIC CC; ASTRA F CLASSIC Caravan; ASTRA G CC (F48_, F08_); ASTRA G Stufenheck (F69_); ASTRA G Caravan (F35_); ASTRA G Kasten (F70); COMBO (71_); CORSA B (73_, 78_, 79_, F35_); CORSA C (F08, F68); OMEGA B Caravan (21_, 22_, 23_); TIGRA (95_); VECTRA B CC (38_); VECTRA B Caravan (31_); VECTRA C GTS; VECTRA C; ZAFIRA (F75_)

SEAT

ALHAMBRA (7V8, 7V9); IBIZA II (6K1); INCA (6K9)

VAUXHALL

AGILA; ASTRA Mk IV CC; ASTRA Mk IV Estate; CORSA; OMEGA Estate; VECTRA Estate; ZAFIRA

VW

CADDY II Kasten (9K9A); CORRADO (53I); GOLF II (19E, 1G1); GOLF III (1H1); GOLF III Variant (1H5); JETTA II (19E, 1G2); PASSAT (3A2, 35I); PASSAT Variant (3A5, 35I); PASSAT (3B2); POLO (86C, 80); POLO Coupe (86C, 80); POLO Kasten (86CF); POLO (6N1); POLO CLASSIC (6KV2); POLO Variant (6KV5); SHARAN (7M8, 7M9, 7M6); VENTO (1H2); TRANSPORTER T4 Bus (70XB, 70XC, 7DB, 7DW); TRANSPORTER T4 Kasten (70XA); TRANSPORTER T4 Pritsche/Fahrgestell (70XD)

Fahrzeugmodelle dienen nur der allgemeinen Information und nicht als ausführliche Anleitung zur Verwendung der Produkte.



246-083-002-022G

Dual - Zentrifugalpumpe

_ Spannung [V]: 12

_ Stecker Nr.: 3

AUDI

A3 (8L1); A3 (8P1); A3 Sportback (8PA); A4 (8D2, B5); A4 Avant (8D5, B5); A4 (8E2, B6); A4 Avant (8E5, B6); A4 (8EC); A4 Avant (8ED); A6 (4B, C5); A6 Avant (4B, C5); ALLROAD (4BH); A6 (4F2); A6 Avant (4F5)

BMW

3 Compact (E36); Z3 Coupe

MERCEDES-BENZ

B-KLASSE (W245)

SEAT

ALHAMBRA (7V8, 7V9); ALTEA (5P1); AROSA (6H); CORDOBA Vario (6K5); CORDOBA (6K2); CORDOBA (6L2); IBIZA III (6K1); IBIZA IV (6L1); INCA (6K9); LEON (1M1); LEON (1P1); TOLEDO II (1M2); TOLEDO III (5P2)

SKODA

FABIA (6Y2); OCTAVIA (1U2); OCTAVIA Combi (1U5); OCTAVIA (1Z3)

SMART

CITY-COUPÉ (MC01); CABRIO

VW

BORA (1J2); BORA Kombi (1J6); CADDY II Kombi (9K9B); CADDY II Kasten (9K9A); CADDY III Kombi (2KB); CADDY III Kasten (2KA); FOX (5Z1); GOLF IV (1J1); GOLF IV Variant (1J5); GOLF V (1K1); GOLF V PLUS (5M1); LUPO (6X1, 6E1); PASSAT (3B2); PASSAT Variant (3B5); PASSAT (3B3); PASSAT Variant (3B6); PASSAT (3C2); POLO Kasten (86CF); POLO (6N1); POLO Kasten (6NF); POLO CLASSIC (6KV2); POLO Variant (6KV5); POLO (6N2); POLO (9N_); POLO Stufenheck; SHARAN (7M8, 7M9, 7M6); TOUAREG (7LA); TOURAN; TRANSPORTER T5 Bus (7HB, 7HJ); TRANSPORTER T5 Kasten (7HA, 7HH)

Fahrzeugmodelle dienen nur der allgemeinen Information und nicht als ausführliche Anleitung zur Verwendung der Produkte.



246-086-001-002C

Scheinwerfer-Reinigungspumpe

- _ Spannung [V]: 12
- _ Stecker Nr.: 3

AUDI

A3 (8L1); A4 (8D2, B5); A4 Avant (8D5, B5); A6 (4A, C4); A6 Avant (4A, C4); A6 (4B, C5); A6 Avant (4B, C5); A8 (4D2, 4D8); TT (8N3); TT Roadster (8N9); 80 (89, 89Q, 8A, B3); COUPE (89, 8B); CABRIOLET (8G7, B4); 80 (8C, B4); 80 Avant (8C, B4); 100 (4A, C4); 100 Avant (4A, C4)

MITSUBISHI

SPACE STAR (DG0)

PORSCHE

911 (996); BOXSTER (986)

SEAT

ALHAMBRA (7V8, 7V9); CORDOBA (6K2/C2); CORDOBA (6K2); IBIZA II (6K1); IBIZA III (6K1); INCA (6K9); LEON (1M1); TOLEDO II (1M2)

SKODA

FABIA (6Y2); OCTAVIA (1U2); OCTAVIA Combi (1U5)

VW

BORA (1J2); BORA Kombi (1J6); CADDY I (14); GOLF III (1H1); GOLF III Variant (1H5); GOLF III Cabriolet (1E7); GOLF IV (1J1); GOLF IV Variant (1J5); GOLF IV Cabriolet (1E7); NEW BEETLE (9C1, 1C1); PASSAT (3A2, 35I); PASSAT Variant (3A5, 35I); PASSAT (3B2); PASSAT Variant (3B5); POLO (86C, 80); POLO Coupe (86C, 80); POLO Kasten (86CF); POLO (6N1); POLO Kasten (6NF); POLO CLASSIC (6KV2); POLO Variant (6KV5); POLO (6N2); SHARAN (7M8, 7M9, 7M6); LT 28-46 II Kasten (2DX0AE); LT 28-46 II Pritsche/Fahrgestell (2DX0FE); TRANSPORTER T4 Bus (70XB, 70XC, 7DB, 7DW); TRANSPORTER T4 Kasten (70XA); TRANSPORTER T4 Pritsche/Fahrgestell (70XD)

Fahrzeugmodelle dienen nur der allgemeinen Information und nicht als ausführliche Anleitung zur Verwendung der Produkte.



246-086-001-007C

Scheinwerfer-Reinigungspumpe

_ Spannung [V]: 12

_ Stecker Nr.: 3b

AUDI

A2 (8Z0); A3 (8L1); A4 (8D2, B5); A4 Avant (8D5, B5); A4 (8E2, B6);
A4 Avant (8E5, B6); A4 Cabriolet (8H7); A6 (4B, C5); A6 Avant (4B, C5); ALLRO-
AD (4BH); A8 (4D2, 4D8); TT (8N3); TT Roadster (8N9); 80 (81, 85, B2);
COUPE (81, 85); QUATTRO (85); 80 (89, 89Q, 8A, B3); COUPE (89, 8B);
80 (8C, B4); 90 (81, 85, B2); 90 (89, 89Q, 8A, B3); 100 (43, C2);
100 Avant (43, C2); 100 (44, 44Q, C3); 100 Avant (44, 44Q, C3); 100 (4A, C4);
100 Avant (4A, C4); 200 (43); 200 (44, 44Q); 200 Avant (44, 44Q)

BMW

1 (E87); 3 (E36); 3 Compact (E36); 3 Cabriolet (E36); 3 (E46); 3 Compact (E46);
3 Coupe (E46); 3 Touring (E46); 5 (E39); 5 Touring (E39); 5 (E60); 5 Touring (E61);
6 (E63); 7 (E38); 7 (E65, E66); X3 (E83); X5 (E53); Z4 (E85)

SEAT

ALHAMBRA (7V8, 7V9); ALTEA (5P1); CORDOBA (6K2/C2); CORDOBA Vario (6K5);
CORDOBA (6K2); CORDOBA (6L2); IBIZA II (6K1); IBIZA III (6K1); IBIZA IV (6L1);
INCA (6K9); LEON (1M1); LEON (1P1); TOLEDO II (1M2); TOLEDO III (5P2)

SKODA

FABIA Stufenheck (6Y3); FABIA Combi (6Y5); OCTAVIA (1U2);
OCTAVIA Combi (1U5); OCTAVIA (1Z3); OCTAVIA Combi (1Z5); SUPERB (3U4)



246-086-001-007C

Scheinwerfer-Reinigungspumpe

- _ Spannung [V]: 12
- _ Stecker Nr.: 3b

VW

BORA (1J2); CADDY I (14); CADDY II Kombi (9K9B); CADDY II Kasten (9K9A); CADDY II Pick-up (9U7); CADDY III Kombi (2KB); CADDY III Kasten (2KA); CORRADO (53I); DERBY (86); DERBY (86C, 80); GOLF I (17); GOLF I Cabriolet (155); GOLF II (19E, 1G1); GOLF III (1H1); GOLF III Variant (1H5); GOLF III Cabriolet (1E7); GOLF IV (1J1); GOLF IV Variant (1J5); GOLF IV Cabriolet (1E7); GOLF V (1K1); GOLF V PLUS (5M1); JETTA I (16); JETTA II (19E, 1G2); JETTA III (1K2); LUPO (6X1, 6E1); NEW BEETLE (9C1, 1C1); NEW BEETLE Cabriolet (1Y7); PASSAT (32B); PASSAT Stufenheck (32B); PASSAT Variant (32B); PASSAT (3A2, 35I); PASSAT Variant (3A5, 35I); PASSAT (3B2); PASSAT (3B3); PASSAT (3C2); PASSAT Variant (3C5); POLO (86); POLO (86C, 80); POLO CLASSIC (86C, 80); POLO Coupe (86C, 80); POLO (6N1); POLO CLASSIC (6KV2); POLO (9N_); POLO Stufenheck; SANTANA (32B); SCIROCCO (53B); SHARAN (7M8, 7M9, 7M6); TOUAREG (7LA); TOURAN; VENTO (1H2); LT 28 I Bus (281-363); LT 28-35 I Kasten (281-363); LT 28-35 I Pritsche/Fahrgestell (281-363); LT 28-35 II Bus (2DM); LT 28-46 II Kasten (2DX0AE); LT 28-46 II Pritsche/Fahrgestell (2DX0FE); TRANSPORTER T2 Bus; TRANSPORTER T2 Kasten; TRANSPORTER T2 Pritsche/Fahrgestell; TRANSPORTER T3 Bus; TRANSPORTER T3 Pritsche/Fahrgestell; TRANSPORTER T4 Bus (70XB, 70XC, 7DB, 7DW); TRANSPORTER T4 Kasten (70XA); TRANSPORTER T4 Pritsche/Fahrgestell (70XD); TRANSPORTER T5 Bus (7HB, 7HJ); TRANSPORTER T5 Kasten (7HA, 7HH); TRANSPORTER T5 Pritsche/Fahrgestell (7JD, 7JE, 7JL)



395-060-017-001C

Niveauschalter

- _ Spannung [V]: 12

Fahrzeugmodelle dienen nur der allgemeinen Information und nicht als ausführliche Anleitung zur Verwendung der Produkte.



395-060-017-002C
Niveauschalter
_ Spannung [V]: 24



395-060-025-001C
Niveauschalter
_ Spannung [V]: 12
_ Spannung [V]: 24



88-205-001
Verbindungsstück



88-243-005
Verbindungsstück

Fahrzeugmodelle dienen nur der allgemeinen Information und nicht als ausführliche Anleitung zur Verwendung der Produkte.



88-267-012
Verbindungsstück



88-326-001
Verbindungsstück



88-326-004
Verbindungsstück



89-602-050
Dichtung
_ Ausrüstung: Mit Filter

Fahrzeugmodelle dienen nur der allgemeinen Information und nicht als ausführliche Anleitung zur Verwendung der Produkte.



X10-729-002-004

Mono - Zentrifugalpumpe

_ Spannung [V]: 12

_ Stecker Nr.: 9

FORD

COUGAR (EC_); ESCORT IV (GAF, AWF, ABFT); ESCORT V (GAL);
ESCORT V Kombi (GAL, AVL); ESCORT V Cabriolet (ALL); ESCORT VI (GAL);
ESCORT VI Kombi (GAL); ESCORT VII (GAL, AAL, ABL);
ESCORT VII Kombi (GAL, ANL); ESCORT VII Cabriolet (ALL); FIESTA III (GFJ);
FIESTA IV (JA_, JB_); FOCUS (DAW, DBW); FOCUS Stufenheck (DFW);
FOCUS Kombi (DNW); KA (RB_); MONDEO I (GBP); MONDEO I Kombi (BNP); MON-
DEO II (BAP); MONDEO II Kombi (BNP); PUMA (EC_); SCORPIO I Kombi (GGE);
TRANSIT Kasten (FA_); TRANSIT Pritsche/Fahrgestell (FM_, FN_)

MAZDA

121 III (JASM, JBSM)



X10-729-002-005

Mono - Zentrifugalpumpe

_ Spannung [V]: 12

_ Stecker Nr.: 9

FORD

ESCORT IV (GAF, AWF, ABFT); ESCORT IV Kombi (AWF, AVF);
ESCORT IV Cabriolet (ALF); ESCORT V (GAL); FIESTA I; FIESTA II (FBD);
FIESTA III (GFJ); FIESTA Courier (F3L, F5L); STREET KA; MONDEO II (BAP);
MONDEO II Stufenheck (BFP); MONDEO II Kombi (BNP); ORION II (AFF);
ORION III (GAL); SCORPIO I (GAE, GGE); SCORPIO I Stufenheck (GGE);
SCORPIO II (GFR, GGR); SCORPIO II Kombi (GMR, GGR); SIERRA (GBG, GB4);
SIERRA Kombi (BNG); TRANSIT Bus (FD_, FB_, FS_, FZ_, FC_);
TRANSIT Kasten (FA_); TRANSIT Pritsche/Fahrgestell (FM_, FN_)

Fahrzeugmodelle dienen nur der allgemeinen Information und nicht als ausführliche Anleitung zur Verwendung der Produkte.

**X10-729-002-006**

Mono - Zentrifugalpumpe

_ Spannung [V]: 12

_ Stecker Nr.: 10

RENAULT

CLIO I (B/C57_, 5/357_); ESPACE II (J/S63_); KANGOO Rapid (FC0/1_);
 MEGANE Classic (LA0/1_); MEGANE Cabriolet (EA0/1_); RAPID Kasten (F40_, G40_);
 SAFRANE I (B54_); SAFRANE II (B54_); 19 I (B/C53_); 19 I Chamade (L53_);
 21 (B48_); 21 Stufenheck (L48_); 21 Kombi (K48_)

**X10-729-002-007**

Mono - Zentrifugalpumpe

_ Spannung [V]: 12

_ Stecker Nr.: 11

CITROËN

AX (ZA-); BERLINGO Kasten (M_); JUMPY (U6U); JUMPY Kasten;
 JUMPY Pritsche/Fahrgestell; XANTIA (X1); XANTIA Break (X1); XANTIA (X2);
 XANTIA Break (X2); XM (Y3); XM Break (Y3); XM (Y4); XM Break (Y4); ZX (N2)

PEUGEOT

106 I (1A, 1C); 206 CC (2D); 306 Schrägheck (7A, 7C, N3, N5); 306 (7B, N3, N5);
 306 Cabriolet (7D, N3, N5); 406 (8B); 406 Break (8E/F); 406 Coupe (8C); 605 (6B);
 EXPERT (224); EXPERT Kasten (222); PARTNER Kasten (5)

**X10-729-002-008**

Mono - Zentrifugalpumpe

_ Spannung [V]: 12

_ Stecker Nr.: 12

FORD

ESCORT III (GAA); ESCORT III Cabriolet (ALD); FIESTA I; FIESTA II (FBD);
 SCORPIO I (GAE, GGE); SIERRA Schrägheck (GBC); SIERRA Schrägheck (GBC, GBG);
 TRANSIT Pritsche/Fahrgestell (V_); TRANSIT Bus (V_); TRANSIT Kasten (V_);
 TRANSIT Bus (T_); TRANSIT Kasten (T_); TRANSIT Pritsche/Fahrgestell (T_);
 TRANSIT Bus (E_); TRANSIT Kasten (E_); TRANSIT Pritsche/Fahrgestell (E_)

Fahrzeugmodelle dienen nur der allgemeinen Information und nicht als ausführliche Anleitung zur Verwendung der Produkte.



X11-246-000-001
Ventil
_ Ventilart: Rückschlagventil



X11-246-003-013
Adapter



X11-246-003-014
Adapter

Fahrzeugmodelle dienen nur der allgemeinen Information und nicht als ausführliche Anleitung zur Verwendung der Produkte.



ALFA ROMEO	36
ALPINA	39
AUDI	39
BMW	100
CITROËN	120
FIAT	127
FORD	137
LADA	168
LANCIA	169
MAZDA	172
MERCEDES-BENZ	173
MINI	173
MITSUBISHI	222



OPEL	223
PEUGEOT	255
PORSCHE	262
RENAULT	266
SAAB	272
SEAT	274
SKODA	292
SMART (MCC)	300
VAUXHALL	301
VOLVO	311
VOLKSWAGEN	320



			VDO		
Datum	Motorcode	Fahrgestell Nr.	Artikel Nr.	Artikelbez.	Information

ALFA ROMEO





145 (930)

1.4 i.e. (66 kW 1.4 Liter)					
07.94 → 12.96	AR 33501		246-083-001-004C	SWP-D-C	T1: 1
1.4 i.e. 16V T.S. (76 kW 1.4 Liter)					
12.96 → 01.01	AR 33503 / AR 38501		246-083-001-004C	SWP-D-C	T1: 1
1.6 i.e. (76 kW 1.6 Liter)					
10.94 → 12.96	AR 33201		246-083-001-004C	SWP-D-C	T1: 1
1.6 i.e. 16V T.S. (88 kW 1.6 Liter)					
12.96 → 01.01	AR 38201 / AR 67601		246-083-001-004C	SWP-D-C	T1: 1
1.7 i.e. 16V (95 kW 1.7 Liter)					
10.94 → 12.96	AR 33401		246-083-001-004C	SWP-D-C	T1: 1
1.8 i.e. 16V T.S. (103 kW 1.8 Liter)					
12.96 → 12.98	AR 38401 / AR 67106		246-083-001-004C	SWP-D-C	T1: 1
1.8 i.e. 16V (106 kW 1.8 Liter)					
03.98 → 01.01	AR 32201		246-083-001-004C	SWP-D-C	T1: 1
2.0 16V T.S. (110 kW 2.0 Liter)					
10.95 → 01.01	AR 67204		246-083-001-004C	SWP-D-C	T1: 1
2.0 16V Quadrifoglio (114 kW 2.0 Liter)					
03.98 → 01.01	AR 32301		246-083-001-004C	SWP-D-C	T1: 1
1.9 TD (66 kW 1.9 Liter)					
10.94 → 02.99	AR 33601 / AR 67501		246-083-001-004C	SWP-D-C	T1: 1
1.9 JTD (77 kW 1.9 Liter)					
02.99 → 01.01	AR 32302		246-083-001-004C	SWP-D-C	T1: 1

146 (930)

1.4 i.e. (66 kW 1.4 Liter)					
12.94 → 12.96	AR 33501		246-083-001-004C	SWP-D-C	T1: 1
1.4 i.e. 16V T.S. (76 kW 1.4 Liter)					
12.97 → 01.01	AR 33503 / AR 38501		246-083-001-004C	SWP-D-C	T1: 1; T8
1.6 i.e. (76 kW 1.6 Liter)					
12.94 → 12.96	AR 33201		246-083-001-004C	SWP-D-C	T1: 1
1.6 i.e. 16V T.S. (88 kW 1.6 Liter)					
12.97 → 01.01	AR 38201 / AR 67601		246-083-001-004C	SWP-D-C	T1: 1; T8
1.7 i.e. 16V (95 kW 1.7 Liter)					
12.94 → 12.96	AR 33401		246-083-001-004C	SWP-D-C	T1: 1
1.8 i.e. 16V T.S. (103 kW 1.8 Liter)					
12.97 → 01.01	AR 38401 / AR 67106		246-083-001-004C	SWP-D-C	T1: 1; T8
1.8 i.e. 16V T.S. (106 kW 1.8 Liter)					
03.98 → 01.01	AR 32201		246-083-001-004C	SWP-D-C	T1: 1; T8



			VDO		
Datum	Motorcode	Fahrgestell Nr.	Artikel Nr.	Artikelbez.	Information

ALFA ROMEO

146 (930)

2.0 16V T.S. (110 kW | 2.0 Liter)

12.97 → 01.01	AR 67204		246-083-001-004C	SWP-D-C	T1: 1; T8
---------------	----------	--	------------------	---------	-----------

2.0 16V Quadrifoglio (114 kW | 2.0 Liter)

03.98 → 01.01	AR 32301		246-083-001-004C	SWP-D-C	T1: 1; T8
---------------	----------	--	------------------	---------	-----------

1.9 TD (66 kW | 1.9 Liter)

12.97 → 02.99	AR 33601 / AR 67501		246-083-001-004C	SWP-D-C	T1: 1; T8
---------------	---------------------	--	------------------	---------	-----------

1.9 JTD (77 kW | 1.9 Liter)

02.99 → 01.01	AR 32302		246-083-001-004C	SWP-D-C	T1: 1; T8
---------------	----------	--	------------------	---------	-----------

147 (937)

1.6 16V T.SPARK ECO (937AXA1A) (76 kW | 1.6 Liter)

01.01 →	AR 37203		246-083-001-004C	SWP-D-C	T1: 1
---------	----------	--	------------------	---------	-------

1.6 16V T.SPARK (937AXB1A) (88 kW | 1.6 Liter)

01.01 →	AR 32104		246-083-001-004C	SWP-D-C	T1: 1
---------	----------	--	------------------	---------	-------

2.0 16V T.SPARK (937AXC1_) (110 kW | 2.0 Liter)

01.01 →	AR 32310		246-083-001-004C	SWP-D-C	T1: 1
---------	----------	--	------------------	---------	-------

3.2 GTA (184 kW | 3.2 Liter)

02.03 →	932 A.000		246-083-001-004C	SWP-D-C	T1: 1
---------	-----------	--	------------------	---------	-------

1.9 JTD (74 kW | 1.9 Liter)

06.03 →	182 B9.000		246-083-001-004C	SWP-D-C	T1: 1
---------	------------	--	------------------	---------	-------

1.9 JTD (937AXD1A) (85 kW | 1.9 Liter)

04.01 →	937 A2.000		246-083-001-004C	SWP-D-C	T1: 1
---------	------------	--	------------------	---------	-------

1.9 JTD 16V (103 kW | 1.9 Liter)

11.02 →	192 A5.000		246-083-001-004C	SWP-D-C	T1: 1
---------	------------	--	------------------	---------	-------

1.9 JTDM 8V (88 kW | 1.9 Liter)

07.05 →			246-083-001-004C	SWP-D-C	T1: 1
---------	--	--	------------------	---------	-------

1.9 JTDM 16V (110 kW | 1.9 Liter)

07.05 →	937 A5.000		246-083-001-004C	SWP-D-C	T1: 1
---------	------------	--	------------------	---------	-------

156 (932)

1.6 16V T.SPARK (932A4) (88 kW | 1.6 Liter)

09.97 →	AR 32102 / AR 32103		246-083-001-004C	SWP-D-C	T1: 1
---------	---------------------	--	------------------	---------	-------

1.8 16V T.SPARK (932A31_) (103 kW | 1.8 Liter)

10.00 →	AR 32205		246-083-001-004C	SWP-D-C	T1: 1
---------	----------	--	------------------	---------	-------

1.8 16V T.SPARK (932A3) (106 kW | 1.8 Liter)

09.97 → 10.00	AR 32201		246-083-001-004C	SWP-D-C	T1: 1
---------------	----------	--	------------------	---------	-------

2.0 16V T.SPARK (932A21_) (110 kW | 2.0 Liter)

10.00 → 03.02	AR 32310		246-083-001-004C	SWP-D-C	T1: 1
---------------	----------	--	------------------	---------	-------



			VDO		
Datum	Motorcode	Fahrgestell Nr.	Artikel Nr.	Artikelbez.	Information

ALFA ROMEO

156 (932)

2.0 16V T.SPARK (932A2) (114 kW 2.0 Liter)					
09.97 → 10.00	AR 32301		246-083-001-004C	SWP-D-C	T1: 1
2.0 JTS (932AXA) (122 kW 2.0 Liter)					
03.02 →	937 A1.000		246-083-001-004C	SWP-D-C	T1: 1
2.5 V6 24V (932A1) (140 kW 2.5 Liter)					
09.97 → 10.00	AR 32401		246-083-001-004C	SWP-D-C	T1: 1
2.5 V6 24V (932A11_) (141 kW 2.5 Liter)					
10.00 →	AR 32405		246-083-001-004C	SWP-D-C	T1: 1
3.2 GTA (932AXB) (184 kW 3.2 Liter)					
03.02 →	932 A.000		246-083-001-004C	SWP-D-C	T1: 1
1.9 JTD (932B2) (77 kW 1.9 Liter)					
09.97 → 10.00	AR 32302		246-083-001-004C	SWP-D-C	T1: 1
1.9 JTD (932A2B_) (81 kW 1.9 Liter)					
10.00 → 05.01	AR 37101		246-083-001-004C	SWP-D-C	T1: 1
1.9 JTD (932A2B, 932A2C) (85 kW 1.9 Liter)					
05.01 →	937 A2.000		246-083-001-004C	SWP-D-C	T1: 1
1.9 JTD 16V (103 kW 1.9 Liter)					
11.02 →	192 A5.000		246-083-001-004C	SWP-D-C	T1: 1
2.4 JTD (932B1) (100 kW 2.4 Liter)					
09.97 → 10.00	AR 32501		246-083-001-004C	SWP-D-C	T1: 1
2.4 JTD (932A1B_) (103 kW 2.4 Liter)					
10.00 →	839 A6.000		246-083-001-004C	SWP-D-C	T1: 1
2.4 JTD (932AXC) (110 kW 2.4 Liter)					
03.02 →	841 C000		246-083-001-004C	SWP-D-C	T1: 1
2.4 JTD (129 kW 2.4 Liter)					
10.03 →	841 G.000		246-083-001-004C	SWP-D-C	T1: 1

156 Sportwagon (932)

1.6 16V T.SPARK. (932A4) (88 kW 1.6 Liter)					
05.00 →	AR 32102 / AR 32103		246-083-001-004C	SWP-D-C	T1: 1
1.8 16V T.SPARK (932B31_) (103 kW 1.8 Liter)					
10.00 →	AR 32205		246-083-001-004C	SWP-D-C	T1: 1
1.8 16V T.SPARK (932A3) (106 kW 1.8 Liter)					
05.00 → 10.00	AR 32201		246-083-001-004C	SWP-D-C	T1: 1
2.0 16V T.SPARK (932B21_) (110 kW 2.0 Liter)					
10.00 → 03.02	AR 32310		246-083-001-004C	SWP-D-C	T1: 1
2.0 16V T.SPARK (932A2) (114 kW 2.0 Liter)					
05.00 → 10.00	AR 32301		246-083-001-004C	SWP-D-C	T1: 1
2.0 JTS (932BXA) (122 kW 2.0 Liter)					
03.02 →	937 A1.000		246-083-001-004C	SWP-D-C	T1: 1
2.5 V6 24V (932A1) (140 kW 2.5 Liter)					
05.00 → 10.00	AR 32401		246-083-001-004C	SWP-D-C	T1: 1
2.5 V6 24V (932B11_) (141 kW 2.5 Liter)					
10.00 →	AR 32405		246-083-001-004C	SWP-D-C	T1: 1



			VDO		
Datum	Motorcode	Fahrgestell Nr.	Artikel Nr.	Artikelbez.	Information

ALFA ROMEO

156 Sportwagon (932)

3.2 GTA (932BXB) (184 kW | 3.2 Liter)

03.02 →	932 A.000		246-083-001-004C	SWP-D-C	T1: 1
---------	-----------	--	------------------	---------	-------

1.9 JTD (932B2) (77 kW | 1.9 Liter)

05.00 → 10.00	AR 32302		246-083-001-004C	SWP-D-C	T1: 1
---------------	----------	--	------------------	---------	-------

1.9 JTD (932B2B_) (81 kW | 1.9 Liter)

10.00 → 05.01	AR 37101		246-083-001-004C	SWP-D-C	T1: 1
---------------	----------	--	------------------	---------	-------

1.9 JTD (932B2B, 932B2C) (85 kW | 1.9 Liter)

05.01 →	937 A2.000		246-083-001-004C	SWP-D-C	T1: 1
---------	------------	--	------------------	---------	-------

1.9 JTD 16V (103 kW | 1.9 Liter)

11.02 →	192 A5.000		246-083-001-004C	SWP-D-C	T1: 1
---------	------------	--	------------------	---------	-------

1.9 JTD 16V Q4 (110 kW | 1.9 Liter)

07.04 →			246-083-001-004C	SWP-D-C	T1: 1
---------	--	--	------------------	---------	-------

2.4 JTD (932B1) (100 kW | 2.4 Liter)

05.00 → 10.00	AR 32501		246-083-001-004C	SWP-D-C	T1: 1
---------------	----------	--	------------------	---------	-------

2.4 JTD (932B1B_) (103 kW | 2.4 Liter)

10.00 →	839 A6.000		246-083-001-004C	SWP-D-C	T1: 1
---------	------------	--	------------------	---------	-------

2.4 JTD (932BXC) (110 kW | 2.4 Liter)

03.02 →	841 C000		246-083-001-004C	SWP-D-C	T1: 1
---------	----------	--	------------------	---------	-------

2.4 JTD (129 kW | 2.4 Liter)

10.03 →	841 G.000		246-083-001-004C	SWP-D-C	T1: 1
---------	-----------	--	------------------	---------	-------

ALPINA

B7 Coupe (E24)

3.5 (243 kW | 3.5 Liter)

05.82 → 08.87			246-075-021-006C	SWP-M-G	T1: 1; T2: B
---------------	--	--	------------------	---------	--------------

3.5 (235 kW | 3.5 Liter)

10.86 → 06.88			246-075-021-006C	SWP-M-G	T1: 1; T2: B
---------------	--	--	------------------	---------	--------------

AUDI

A2 (8Z0)

1.4 (55 kW | 1.4 Liter)

02.00 →	AUA / BBY		246-086-001-007C	HLWP	T1: 3b; T3: X11-246-003-014
---------	-----------	--	------------------	------	--------------------------------

1.6 FSI (81 kW | 1.6 Liter)

05.02 →	BAD		246-086-001-007C	HLWP	T1: 3b; T3: X11-246-003-014
---------	-----	--	------------------	------	--------------------------------



			VDO		
Datum	Motorcode	Fahrgestell Nr.	Artikel Nr.	Artikelbez.	Information

AUDI**A2 (8Z0)****1.2 TDI (45 kW | 1.2 Liter)**

04.01 →	ANY		246-082-008-025G	SWP-M-C	T1: 3
03.01 →	ANY		246-086-001-007C	HLWP	T1: 3b; T3: X11-246-003-014

1.4 TDI (55 kW | 1.4 Liter)

02.00 →	AMF / BHC		246-086-001-007C	HLWP	T1: 3b; T3: X11-246-003-014
---------	-----------	--	------------------	------	--------------------------------

1.4 TDI (66 kW | 1.4 Liter)

11.03 →	ATL		246-082-008-025G	SWP-M-C	T1: 3
11.03 →	ATL		246-086-001-007C	HLWP	T1: 3b

A3 (8L1)**1.6 (74 kW | 1.6 Liter)**

09.96 → 07.98	AEH / AKL / APF		246-083-002-022G	SWP-D-C	T1: 3
09.96 → 07.98	AEH / AKL / APF		246-086-001-002C	HLWP	T1: 3
09.96 → 08.00	AEH / AKL / APF		246-086-001-007C	HLWP	T1: 3b; T3: X11-246-003-014

1.6 (75 kW | 1.6 Liter)

08.00 →	AVU / BFQ		246-083-002-022G	SWP-D-C	T1: 3
08.00 →	AVU / BFQ		246-086-001-007C	HLWP	T1: 3b; T3: X11-246-003-014

1.8 (92 kW | 1.8 Liter)

09.96 → 07.98	AGN / APG		246-083-002-022G	SWP-D-C	T1: 3
09.96 → 07.98	AGN / APG		246-086-001-002C	HLWP	T1: 3
09.96 →	AGN / APG		246-086-001-007C	HLWP	T1: 3b; T3: X11-246-003-014

1.8 quattro (92 kW | 1.8 Liter)

08.98 →	AGN		246-083-002-022G	SWP-D-C	T1: 3
08.98 →	AGN		246-086-001-007C	HLWP	T1: 3b; T3: X11-246-003-014

1.8 T (110 kW | 1.8 Liter)

12.96 → 05.99	AGU / AQA / ARZ / AUM		246-083-002-022G	SWP-D-C	T1: 3
12.96 → 05.99	AGU / AQA / ARZ / AUM		246-086-001-002C	HLWP	T1: 3
12.96 →	AGU / AQA / ARZ / AUM		246-086-001-007C	HLWP	T1: 3b; T3: X11-246-003-014

1.8 T quattro (110 kW | 1.8 Liter)

08.97 → 07.98	AGU / AQA / ARX		246-083-002-022G	SWP-D-C	T1: 3
08.97 → 07.98	AGU / AQA / ARX		246-086-001-002C	HLWP	T1: 3
12.96 →	AGU / AQA / ARX		246-086-001-007C	HLWP	T1: 3b; T3: X11-246-003-014



			VDO		
Datum	Motorcode	Fahrgestell Nr.	Artikel Nr.	Artikelbez.	Information

AUDI**A3 (8L1)****1.8 T (132 kW | 1.8 Liter)**

12.98 →	AJQ / APP / ARY / AUQ		246-083-002-022G	SWP-D-C	T1: 3
12.98 →	AJQ / APP / ARY / AUQ		246-086-001-002C	HLWP	T1: 3
12.98 →	AJQ / APP / ARY / AUQ		246-086-001-007C	HLWP	T1: 3b; T3: X11-246-003-014

1.8 T quattro (132 kW | 1.8 Liter)

11.98 →	AJQ / ARY		246-083-002-022G	SWP-D-C	T1: 3
11.98 →	AJQ / ARY		246-086-001-002C	HLWP	T1: 3
10.98 →	AJQ / ARY		246-086-001-007C	HLWP	T1: 3b; T3: X11-246-003-014

S3 quattro (154 kW | 1.8 Liter)

03.99 →	AMK / APY / AUL		246-083-002-022G	SWP-D-C	T1: 3
03.99 →	AMK / APY / AUL		246-086-001-002C	HLWP	T1: 3
03.99 →	AMK / APY / AUL		246-086-001-007C	HLWP	T1: 3b; T3: X11-246-003-014

S3 quattro (165 kW | 1.8 Liter)

10.01 →	BAM		246-083-002-022G	SWP-D-C	T1: 3
10.01 →	BAM		246-086-001-007C	HLWP	T1: 3b; T3: X11-246-003-014

1.9 TDI (66 kW | 1.9 Liter)

09.96 → 08.99	AGR / ALH		246-083-002-022G	SWP-D-C	T1: 3
09.96 → 08.99	AGR / ALH		246-086-001-002C	HLWP	T1: 3
09.96 → 07.01	AGR / ALH		246-086-001-007C	HLWP	T1: 3b; T3: X11-246-003-014

1.9 TDI (74 kW | 1.9 Liter)

10.00 →	ATD / AXR		246-083-002-022G	SWP-D-C	T1: 3
10.00 →	ATD / AXR		246-086-001-007C	HLWP	T1: 3b; T3: X11-246-003-014

1.9 TDI (81 kW | 1.9 Liter)

08.97 → 07.98	AHF / ASV		246-083-002-022G	SWP-D-C	T1: 3
08.97 → 07.98	AHF / ASV		246-086-001-002C	HLWP	T1: 3
08.97 → 07.01	AHF / ASV		246-086-001-007C	HLWP	T1: 3b; T3: X11-246-003-014

1.9 TDI (96 kW | 1.9 Liter)

08.00 →	ASZ		246-083-002-022G	SWP-D-C	T1: 3
08.00 →	ASZ		246-086-001-007C	HLWP	T1: 3b; T3: X11-246-003-014

1.9 TDI quattro (96 kW | 1.9 Liter)

08.00 →	ASZ		246-083-002-022G	SWP-D-C	T1: 3
08.00 →	ASZ		246-086-001-007C	HLWP	T1: 3b; T3: X11-246-003-014



			VDO		
Datum	Motorcode	Fahrgestell Nr.	Artikel Nr.	Artikelbez.	Information

AUDI

A3 (8P1)

1.6 (75 kW | 1.6 Liter)

05.03 →	BGU		246-083-002-022G	SWP-D-C	T1: 3
---------	-----	--	------------------	---------	-------

1.6 FSI (85 kW | 1.6 Liter)

08.03 →	BAG / BLP		246-083-002-022G	SWP-D-C	T1: 3
---------	-----------	--	------------------	---------	-------

2.0 FSI (110 kW | 2.0 Liter)

05.03 →	AXW / BLR / BLX / BLY / BMB / BVY / BVZ		246-083-002-022G	SWP-D-C	T1: 3
---------	--------------------------------------------	--	------------------	---------	-------

2.0 TFSI (147 kW | 2.0 Liter)

09.04 →	AXX		246-083-002-022G	SWP-D-C	T1: 3
---------	-----	--	------------------	---------	-------

2.0 TFSI quattro (147 kW | 2.0 Liter)

09.04 →	AXX		246-083-002-022G	SWP-D-C	T1: 3
---------	-----	--	------------------	---------	-------

3.2 V6 quattro (184 kW | 3.2 Liter)

07.03 →	BDB / BMJ		246-083-002-022G	SWP-D-C	T1: 3
---------	-----------	--	------------------	---------	-------

1.9 TDI (77 kW | 1.9 Liter)

05.03 →	BKC		246-083-002-022G	SWP-D-C	T1: 3
---------	-----	--	------------------	---------	-------

2.0 TDI (100 kW | 2.0 Liter)

05.03 →	AZV		246-083-002-022G	SWP-D-C	T1: 3
---------	-----	--	------------------	---------	-------

2.0 TDI quattro (100 kW | 2.0 Liter)

05.03 →	AZV		246-083-002-022G	SWP-D-C	T1: 3
---------	-----	--	------------------	---------	-------

2.0 TDI (103 kW | 2.0 Liter)

05.03 →	BKD / BMM		246-083-002-022G	SWP-D-C	T1: 3
---------	-----------	--	------------------	---------	-------

2.0 TDI quattro (103 kW | 2.0 Liter)

08.04 →	BKD / BMM		246-083-002-022G	SWP-D-C	T1: 3
---------	-----------	--	------------------	---------	-------

A3 Sportback (8PA)

1.6 (75 kW | 1.6 Liter)

09.04 →	BGU		246-083-002-022G	SWP-D-C	T1: 3
---------	-----	--	------------------	---------	-------

1.6 FSI (85 kW | 1.6 Liter)

09.04 →	BLP		246-083-002-022G	SWP-D-C	T1: 3
---------	-----	--	------------------	---------	-------

2.0 FSI (110 kW | 2.0 Liter)

09.04 →	BLR / BLX / BLY / BMB / BVY / BVZ		246-083-002-022G	SWP-D-C	T1: 3
---------	--------------------------------------	--	------------------	---------	-------

2.0 TFSI (147 kW | 2.0 Liter)

09.04 →	AXX		246-083-002-022G	SWP-D-C	T1: 3
---------	-----	--	------------------	---------	-------

2.0 TFSI quattro (147 kW | 2.0 Liter)

09.04 →	AXX		246-083-002-022G	SWP-D-C	T1: 3
---------	-----	--	------------------	---------	-------

3.2 quattro (184 kW | 3.2 Liter)

09.04 →	BMJ		246-083-002-022G	SWP-D-C	T1: 3
---------	-----	--	------------------	---------	-------

1.9 TDI (77 kW | 1.9 Liter)

09.04 →	BKC		246-083-002-022G	SWP-D-C	T1: 3
---------	-----	--	------------------	---------	-------

2.0 TDI (100 kW | 2.0 Liter)

09.04 →	AZV		246-083-002-022G	SWP-D-C	T1: 3
---------	-----	--	------------------	---------	-------

2.0 TDI (103 kW | 2.0 Liter)

09.04 →	BKD / BMM		246-083-002-022G	SWP-D-C	T1: 3
---------	-----------	--	------------------	---------	-------



			VDO		
Datum	Motorcode	Fahrgestell Nr.	Artikel Nr.	Artikelbez.	Information

AUDI**A3 Sportback (8PA)****2.0 TDI quattro (103 kW | 2.0 Liter)**

11.05 →	BMM		246-083-002-022G	SWP-D-C	T1: 3
---------	-----	--	------------------	---------	-------

A4 (8D2, B5)**1.6 (74 kW | 1.6 Liter)**

08.97 → 07.99	ADP / AHL / ANA / ARM	W - 000 001 →	246-082-008-025G	SWP-M-C	T1: 3
01.95 → 07.99	ADP / AHL / ANA / ARM		246-086-001-002C	HLWP	T1: 3
01.95 → 07.00	ADP / AHL / ANA / ARM		246-086-001-007C	HLWP	T1: 3b; T3: X11-246-003-014

1.6 (75 kW | 1.6 Liter)

07.00 → 11.00	ALZ		246-086-001-007C	HLWP	T1: 3b; T3: X11-246-003-014
---------------	-----	--	------------------	------	--------------------------------

1.8 (85 kW | 1.8 Liter)

08.97 → 12.98	AFY	W - 000 001 →	246-082-008-025G	SWP-M-C	T1: 3
07.95 → 12.98	AFY		246-086-001-002C	HLWP	T1: 3
04.95 → 11.00	AFY		246-086-001-007C	HLWP	T1: 3b; T3: X11-246-003-014

1.8 quattro (85 kW | 1.8 Liter)

08.97 → 12.98	AFY	W - 000 001 →	246-082-008-025G	SWP-M-C	T1: 3
07.95 → 12.98	AFY		246-086-001-002C	HLWP	T1: 3
07.95 → 11.00	AFY		246-086-001-007C	HLWP	T1: 3b; T3: X11-246-003-014

1.8 (92 kW | 1.8 Liter)

08.97 → 07.99	ADR / APT / ARG / AVV	W - 000 001 →	246-082-008-025G	SWP-M-C	T1: 3
01.95 → 07.99	ADR / APT / ARG / AVV		246-086-001-002C	HLWP	T1: 3
01.95 → 11.00	ADR / APT / ARG / AVV		246-086-001-007C	HLWP	T1: 3b; T3: X11-246-003-014

1.8 quattro (92 kW | 1.8 Liter)

08.97 → 07.99	ADR / APT / ARG	W - 000 001 →	246-082-008-025G	SWP-M-C	T1: 3
01.95 → 07.99	ADR / APT / ARG		246-086-001-002C	HLWP	T1: 3
01.95 → 11.00	ADR / APT / ARG		246-086-001-007C	HLWP	T1: 3b; T3: X11-246-003-014

1.8 (95 kW | 1.8 Liter)

01.95 → 11.00			246-086-001-007C	HLWP	T1: 3b; T3: X11-246-003-014
---------------	--	--	------------------	------	--------------------------------

1.8 T (110 kW | 1.8 Liter)

08.97 → 07.99	AEB / ANB / APU / ARK / AWT	W - 000 001 →	246-082-008-025G	SWP-M-C	T1: 3
01.95 → 07.99	AEB / ANB / APU / ARK / AWT		246-086-001-002C	HLWP	T1: 3
01.95 → 11.00	AEB / ANB / APU / ARK / AWT		246-086-001-007C	HLWP	T1: 3b; T3: X11-246-003-014



			VDO		
Datum	Motorcode	Fahrgestell Nr.	Artikel Nr.	Artikelbez.	Information

AUDI**A4 (8D2, B5)****1.8 T quattro (110 kW | 1.8 Liter)**

08.97 → 07.99	AEB / ANB / APU / ARK / AWT	W - 000 001 →	246-082-008-025G	SWP-M-C	T1: 3
01.95 → 07.99	AEB / ANB / APU / ARK / AWT		246-086-001-002C	HLWP	T1: 3
01.95 → 11.00	AEB / ANB / APU / ARK / AWT		246-086-001-007C	HLWP	T1: 3b; T3: X11-246-003-014

1.8 T (132 kW | 1.8 Liter)

12.97 → 12.98	AJL		246-082-008-025G	SWP-M-C	T1: 3
12.97 → 12.98	AJL		246-086-001-002C	HLWP	T1: 3
12.97 → 11.00	AJL		246-086-001-007C	HLWP	T1: 3b; T3: X11-246-003-014

1.8 T quattro (132 kW | 1.8 Liter)

12.97 → 12.98	AJL		246-082-008-025G	SWP-M-C	T1: 3
12.97 → 12.98	AJL		246-086-001-002C	HLWP	T1: 3
12.97 → 11.00	AJL		246-086-001-007C	HLWP	T1: 3b; T3: X11-246-003-014

2.4 (120 kW | 2.4 Liter)

08.97 → 11.00	AJG / AMM / APZ		246-086-001-007C	HLWP	T1: 3b; T3: X11-246-003-014
---------------	-----------------	--	------------------	------	--------------------------------

2.4 quattro (120 kW | 2.4 Liter)

08.97 → 11.00	APZ		246-086-001-007C	HLWP	T1: 3b; T3: X11-246-003-014
---------------	-----	--	------------------	------	--------------------------------

2.4 (121 kW | 2.4 Liter)

08.97 → 07.99	AGA / ALF / AML / APS / ARJ		246-082-008-025G	SWP-M-C	T1: 3
03.97 → 07.99	AGA / ALF / AML / APS / ARJ		246-086-001-002C	HLWP	T1: 3
03.97 → 11.00	AGA / ALF / AML / APS / ARJ		246-086-001-007C	HLWP	T1: 3b; T3: X11-246-003-014

2.4 quattro (121 kW | 2.4 Liter)

08.97 → 07.99	AGA / ALF / AML / APS / ARJ		246-082-008-025G	SWP-M-C	T1: 3
08.97 → 07.99	AGA / ALF / AML / APS / ARJ		246-086-001-002C	HLWP	T1: 3
03.97 → 11.00	AGA / ALF / AML / APS / ARJ		246-086-001-007C	HLWP	T1: 3b; T3: X11-246-003-014





2.6 (110 kW | 2.6 Liter)

08.97 → 07.98	ABC	W - 000 001 →	246-082-008-025G	SWP-M-C	T1: 3
01.95 → 07.98	ABC		246-086-001-002C	HLWP	T1: 3
01.95 → 11.00	ABC		246-086-001-007C	HLWP	T1: 3b; T3: X11-246-003-014

2.6 quattro (110 kW | 2.6 Liter)

08.97 → 12.98	ABC	W - 000 001 →	246-082-008-025G	SWP-M-C	T1: 3
01.95 → 12.98	ABC		246-086-001-002C	HLWP	T1: 3
01.95 → 11.00	ABC		246-086-001-007C	HLWP	T1: 3b; T3: X11-246-003-014



			VDO		
Datum	Motorcode	Fahrgestell Nr.	Artikel Nr.	Artikelbez.	Information

AUDI**A4 (8D2, B5)****S4 quattro (195 kW | 2.7 Liter)**

10.97 → 01.99	AGB		246-082-008-025G	SWP-M-C	T1: 3
10.97 → 01.99	AGB		246-086-001-002C	HLWP	T1: 3
09.97 → 11.00	AGB		246-086-001-007C	HLWP	T1: 3b; T3: X11-246-003-014

2.8 (128 kW | 2.8 Liter)

09.95 → 07.97	AAH		246-086-001-002C	HLWP	T1: 3
09.95 → 07.97	AAH		246-086-001-007C	HLWP	T1: 3b; T3: X11-246-003-014

2.8 quattro (128 kW | 2.8 Liter)

01.95 → 07.97	AAH		246-086-001-002C	HLWP	T1: 3
01.95 → 07.97	AAH		246-086-001-007C	HLWP	T1: 3b; T3: X11-246-003-014

2.8 (142 kW | 2.8 Liter)

08.97 → 12.98	ACK / ALG / AMX / APR / AQD	W - 000 001 →	246-082-008-025G	SWP-M-C	T1: 3
10.96 → 12.98	ACK / ALG / AMX / APR / AQD		246-086-001-002C	HLWP	T1: 3
10.96 → 11.00	ACK / ALG / AMX / APR / AQD		246-086-001-007C	HLWP	T1: 3b; T3: X11-246-003-014

2.8 quattro (142 kW | 2.8 Liter)

08.97 → 07.99	ACK / ALG / AMX / APR / AQD		246-082-008-025G	SWP-M-C	T1: 3
08.97 → 07.99	ACK / ALG / AMX / APR / AQD		246-086-001-002C	HLWP	T1: 3
10.96 → 11.00	ACK / ALG / AMX / APR / AQD		246-086-001-007C	HLWP	T1: 3b; T3: X11-246-003-014

1.9 TDI (55 kW | 1.9 Liter)

08.97 → 12.98	AFF	W - 000 001 →	246-082-008-025G	SWP-M-C	T1: 3
12.95 → 12.98	AFF		246-086-001-002C	HLWP	T1: 3
12.95 → 11.00	AFF		246-086-001-007C	HLWP	T1: 3b; T3: X11-246-003-014

1.9 TDI (66 kW | 1.9 Liter)

08.97 → 12.98	1Z / AHH / AHU	W - 000 001 →	246-082-008-025G	SWP-M-C	T1: 3
01.95 → 12.98	1Z / AHH / AHU		246-086-001-002C	HLWP	T1: 3
01.95 → 11.00	1Z / AHH / AHU		246-086-001-007C	HLWP	T1: 3b; T3: X11-246-003-014

1.9 TDI (81 kW | 1.9 Liter)

08.97 → 12.98	AFN / AVG	W - 000 001 →	246-082-008-025G	SWP-M-C	T1: 3
02.96 → 12.98	AFN / AVG		246-086-001-002C	HLWP	T1: 3
10.95 → 11.00	AFN / AVG		246-086-001-007C	HLWP	T1: 3b; T3: X11-246-003-014

1.9 TDI quattro (81 kW | 1.9 Liter)

02.99 → 07.99	AFN / AVG		246-082-008-025G	SWP-M-C	T1: 3
02.99 → 07.99	AFN / AVG		246-086-001-002C	HLWP	T1: 3
09.96 → 11.00	AFN / AVG		246-086-001-007C	HLWP	T1: 3b; T3: X11-246-003-014



			VDO		
Datum	Motorcode	Fahrgestell Nr.	Artikel Nr.	Artikelbez.	Information

AUDI**A4 (8D2, B5)****1.9 TDI (85 kW | 1.9 Liter)**

03.00 → 11.00	AJM		246-083-002-022G	SWP-D-C	T1: 3
03.00 → 11.00	AJM		246-086-001-007C	HLWP	T1: 3b; T3: X11-246-003-014

1.9 TDI quattro (85 kW | 1.9 Liter)

03.00 → 11.00	AJM / ATJ		246-086-001-007C	HLWP	T1: 3b; T3: X11-246-003-014
---------------	-----------	--	------------------	------	--------------------------------

2.5 TDI (110 kW | 2.5 Liter)

09.97 → 07.99	AFB / AKN	W - 000 001 →	246-082-008-025G	SWP-M-C	T1: 3
11.97 → 07.99	AFB / AKN		246-086-001-002C	HLWP	T1: 3
09.97 → 11.00	AFB / AKN		246-086-001-007C	HLWP	T1: 3b; T3: X11-246-003-014

2.5 TDI quattro (110 kW | 2.5 Liter)

11.97 → 07.99	AFB / AKN		246-082-008-025G	SWP-M-C	T1: 3
11.97 → 07.99	AFB / AKN		246-086-001-002C	HLWP	T1: 3
09.97 → 11.00	AFB / AKN		246-086-001-007C	HLWP	T1: 3b; T3: X11-246-003-014

A4 Avant (8D5, B5)**1.6 (74 kW | 1.6 Liter)**

08.97 → 07.99	ADP / AHL / ANA / ARM	W - 000 001 →	246-082-008-025G	SWP-M-C	T1: 3
08.97 → 07.99	ADP / AHL / ANA / ARM	W - 000 001 →	246-083-002-022G	SWP-D-C	T1: 3
03.96 → 07.99	ADP / AHL / ANA / ARM		246-086-001-002C	HLWP	T1: 3
03.96 → 07.00	ADP / AHL / ANA / ARM		246-086-001-007C	HLWP	T1: 3b; T3: X11-246-003-014

1.6 (75 kW | 1.6 Liter)

07.00 → 09.01	ALZ		246-083-002-022G	SWP-D-C	T1: 3
07.00 → 09.01	ALZ		246-086-001-007C	HLWP	T1: 3b; T3: X11-246-003-014

1.8 (85 kW | 1.8 Liter)

02.99 → 09.01	AFY		246-082-008-025G	SWP-M-C	T1: 3
02.99 → 09.01	AFY		246-083-002-022G	SWP-D-C	T1: 3
07.95 → 07.97	AFY		246-086-001-002C	HLWP	T1: 3
07.95 → 09.01	AFY		246-086-001-007C	HLWP	T1: 3b; T3: X11-246-003-014

1.8 quattro (85 kW | 1.8 Liter)

08.97 → 12.98	AFY		246-082-008-025G	SWP-M-C	T1: 3
08.97 → 12.98	AFY		246-083-002-022G	SWP-D-C	T1: 3
08.97 → 12.98	AFY		246-086-001-002C	HLWP	T1: 3
07.95 → 09.01	AFY		246-086-001-007C	HLWP	T1: 3b; T3: X11-246-003-014



			VDO		
Datum	Motorcode	Fahrgestell Nr.	Artikel Nr.	Artikelbez.	Information

AUDI**A4 Avant (8D5, B5)****1.8 (92 kW | 1.8 Liter)**

08.97 → 07.99	ADR / APT / ARG / AVV	W - 000 001 →	246-082-008-025G	SWP-M-C	T1: 3
08.97 → 07.99	ADR / APT / ARG / AVV	W - 000 001 →	246-083-002-022G	SWP-D-C	T1: 3
02.96 → 07.99	ADR / APT / ARG / AVV		246-086-001-002C	HLWP	T1: 3
02.96 → 09.01	ADR / APT / ARG / AVV		246-086-001-007C	HLWP	T1: 3b; T3: X11-246-003-014

1.8 quattro (92 kW | 1.8 Liter)

08.97 → 07.99	ADR / APT / ARG	W - 000 001 →	246-082-008-025G	SWP-M-C	T1: 3
08.97 → 07.99	ADR / APT / ARG	W - 000 001 →	246-083-002-022G	SWP-D-C	T1: 3
02.96 → 07.99	ADR / APT / ARG		246-086-001-002C	HLWP	T1: 3
01.96 → 09.01	ADR / APT / ARG		246-086-001-007C	HLWP	T1: 3b; T3: X11-246-003-014

1.8 T (110 kW | 1.8 Liter)

08.97 → 07.99	AEB / ANB / APU / ARK / AWT	W - 000 001 →	246-082-008-025G	SWP-M-C	T1: 3
08.97 → 07.99	AEB / ANB / APU / ARK / AWT	W - 000 001 →	246-083-002-022G	SWP-D-C	T1: 3
03.96 → 07.99	AEB / ANB / APU / ARK / AWT		246-086-001-002C	HLWP	T1: 3
03.96 → 09.01	AEB / ANB / APU / ARK / AWT		246-086-001-007C	HLWP	T1: 3b; T3: X11-246-003-014

1.8 T quattro (110 kW | 1.8 Liter)

08.97 → 12.98	AEB / ANB / APU / ARK / AWT	W - 000 001 →	246-082-008-025G	SWP-M-C	T1: 3
08.97 → 01.99	AEB / ANB / APU / ARK / AWT	W - 000 001 →	246-083-002-022G	SWP-D-C	T1: 3
02.96 → 01.99	AEB / ANB / APU / ARK / AWT		246-086-001-002C	HLWP	T1: 3
01.96 → 09.01	AEB / ANB / APU / ARK / AWT		246-086-001-007C	HLWP	T1: 3b; T3: X11-246-003-014

1.8 T (132 kW | 1.8 Liter)

12.97 → 12.98	AJL	W - 000 001 →	246-082-008-025G	SWP-M-C	T1: 3
12.97 → 12.98	AJL	W - 000 001 →	246-083-002-022G	SWP-D-C	T1: 3
12.97 → 12.98	AJL		246-086-001-002C	HLWP	T1: 3
12.97 → 09.01	AJL		246-086-001-007C	HLWP	T1: 3b; T3: X11-246-003-014

1.8 T quattro (132 kW | 1.8 Liter)

12.97 → 12.98	AJL		246-082-008-025G	SWP-M-C	T1: 3
12.97 → 12.98	AJL		246-083-002-022G	SWP-D-C	T1: 3
12.97 → 12.98	AJL		246-086-001-002C	HLWP	T1: 3
12.97 → 09.01	AJL		246-086-001-007C	HLWP	T1: 3b; T3: X11-246-003-014

2.4 (120 kW | 2.4 Liter)

08.97 → 09.01	AJG / AMM / APZ		246-083-002-022G	SWP-D-C	T1: 3
08.97 → 09.01	AJG / AMM / APZ		246-086-001-007C	HLWP	T1: 3b; T3: X11-246-003-014

2.4 quattro (120 kW | 2.4 Liter)

08.97 → 09.01	APZ		246-083-002-022G	SWP-D-C	T1: 3
08.97 → 09.01	APZ		246-086-001-007C	HLWP	T1: 3b; T3: X11-246-003-014



			VDO		
Datum	Motorcode	Fahrgestell Nr.	Artikel Nr.	Artikelbez.	Information

AUDI**A4 Avant (8D5, B5)****2.4 (121 kW | 2.4 Liter)**

08.97 → 07.99	AGA / ALF / AML / APS / ARJ	W - 000 001 →	246-082-008-025G	SWP-M-C	T1: 3
08.97 → 07.99	AGA / ALF / AML / APS / ARJ	W - 000 001 →	246-083-002-022G	SWP-D-C	T1: 3
03.97 → 07.99	AGA / ALF / AML / APS / ARJ		246-086-001-002C	HLWP	T1: 3
03.97 → 09.01	AGA / ALF / AML / APS / ARJ		246-086-001-007C	HLWP	T1: 3b; T3: X11-246-003-014

2.4 quattro (121 kW | 2.4 Liter)

08.97 → 12.98	AGA / ALF / AML / APS / ARJ		246-082-008-025G	SWP-M-C	T1: 3
08.97 → 12.98	AGA / ALF / AML / APS / ARJ		246-083-002-022G	SWP-D-C	T1: 3
08.97 → 12.98	AGA / ALF / AML / APS / ARJ		246-086-001-002C	HLWP	T1: 3
03.97 → 09.01	AGA / ALF / AML / APS / ARJ		246-086-001-007C	HLWP	T1: 3b; T3: X11-246-003-014

2.6 (110 kW | 2.6 Liter)

08.97 → 07.98	ABC	W - 000 001 →	246-082-008-025G	SWP-M-C	T1: 3
08.97 → 07.98	ABC	W - 000 001 →	246-083-002-022G	SWP-D-C	T1: 3
02.96 → 07.98	ABC		246-086-001-002C	HLWP	T1: 3
02.96 → 09.01	ABC		246-086-001-007C	HLWP	T1: 3b; T3: X11-246-003-014

2.6 quattro (110 kW | 2.6 Liter)

08.97 → 07.98	ABC		246-082-008-025G	SWP-M-C	T1: 3
08.97 → 07.98	ABC		246-083-002-022G	SWP-D-C	T1: 3
08.97 → 07.98	ABC		246-086-001-002C	HLWP	T1: 3
01.96 → 09.01	ABC		246-086-001-007C	HLWP	T1: 3b; T3: X11-246-003-014

S4 quattro (195 kW | 2.7 Liter)

10.97 → 01.99	AGB		246-082-008-025G	SWP-M-C	T1: 3
10.97 → 01.99	AGB		246-083-002-022G	SWP-D-C	T1: 3
10.97 → 01.99	AGB		246-086-001-002C	HLWP	T1: 3
09.97 → 09.01	AGB		246-086-001-007C	HLWP	T1: 3b; T3: X11-246-003-014

RS4 quattro (280 kW | 2.7 Liter)

05.00 → 09.01	ASJ / AZR		246-083-002-022G	SWP-D-C	T1: 3
05.00 → 09.01	ASJ / AZR		246-086-001-007C	HLWP	T1: 3b; T3: X11-246-003-014





2.8 (128 kW | 2.8 Liter)

03.96 → 09.96	AAH		246-086-001-002C	HLWP	T1: 3
03.96 → 09.96	AAH		246-086-001-007C	HLWP	T1: 3b; T3: X11-246-003-014

2.8 quattro (128 kW | 2.8 Liter)

01.96 → 09.96	AAH		246-083-002-022G	SWP-D-C	T1: 3
01.96 → 09.96	AAH		246-086-001-007C	HLWP	T1: 3b; T3: X11-246-003-014



			VDO		
Datum	Motorcode	Fahrgestell Nr.	Artikel Nr.	Artikelbez.	Information

AUDI**A4 Avant (8D5, B5)****2.8 (142 kW | 2.8 Liter)**

08.97 → 12.98	ACK / ALG / AMX / APR / AQD	W - 000 001 →	246-082-008-025G	SWP-M-C	T1: 3
08.97 → 12.98	ACK / ALG / AMX / APR / AQD	W - 000 001 →	246-083-002-022G	SWP-D-C	T1: 3
10.96 → 12.98	ACK / ALG / AMX / APR / AQD		246-086-001-002C	HLWP	T1: 3
10.96 → 09.01	ACK / ALG / AMX / APR / AQD		246-086-001-007C	HLWP	T1: 3b; T3: X11-246-003-014

2.8 quattro (142 kW | 2.8 Liter)

08.97 → 07.99	ACK / ALG / AMX / APR / AQD		246-082-008-025G	SWP-M-C	T1: 3
08.97 → 07.99	ACK / ALG / AMX / APR / AQD		246-083-002-022G	SWP-D-C	T1: 3
08.97 → 07.99	ACK / ALG / AMX / APR / AQD		246-086-001-002C	HLWP	T1: 3
10.96 → 09.01	ACK / ALG / AMX / APR / AQD		246-086-001-007C	HLWP	T1: 3b; T3: X11-246-003-014

1.9 TDI (55 kW | 1.9 Liter)

08.97 → 12.98	AFF	W - 000 001 →	246-082-008-025G	SWP-M-C	T1: 3
08.97 → 12.98	AFF	W - 000 001 →	246-083-002-022G	SWP-D-C	T1: 3
08.96 → 12.98	AFF		246-086-001-002C	HLWP	T1: 3
03.96 → 09.01	AFF		246-086-001-007C	HLWP	T1: 3b; T3: X11-246-003-014

1.9 TDI (66 kW | 1.9 Liter)

08.97 → 12.98	1Z / AHH / AHU	W - 000 001 →	246-082-008-025G	SWP-M-C	T1: 3
08.97 → 12.98	1Z / AHH / AHU	W - 000 001 →	246-083-002-022G	SWP-D-C	T1: 3
02.96 → 12.98	1Z / AHH / AHU		246-086-001-002C	HLWP	T1: 3
02.96 → 09.01	1Z / AHH / AHU		246-086-001-007C	HLWP	T1: 3b; T3: X11-246-003-014

1.9 TDI (81 kW | 1.9 Liter)

08.97 → 07.98	AFN / AVG	W - 000 001 →	246-082-008-025G	SWP-M-C	T1: 3
08.97 → 07.98	AFN / AVG	W - 000 001 →	246-083-002-022G	SWP-D-C	T1: 3
02.96 → 07.98	AFN / AVG		246-086-001-002C	HLWP	T1: 3
02.96 → 09.01	AFN / AVG		246-086-001-007C	HLWP	T1: 3b; T3: X11-246-003-014

1.9 TDI quattro (81 kW | 1.9 Liter)

02.99 → 07.99	AFN / AVG		246-082-008-025G	SWP-M-C	T1: 3
02.99 → 07.99	AFN / AVG		246-083-002-022G	SWP-D-C	T1: 3
02.99 → 07.99	AFN / AVG		246-086-001-002C	HLWP	T1: 3
09.96 → 09.01	AFN / AVG		246-086-001-007C	HLWP	T1: 3b; T3: X11-246-003-014

1.9 TDI (85 kW | 1.9 Liter)

03.00 → 09.01	AJM		246-082-008-025G	SWP-M-C	T1: 3
03.00 → 09.01	AJM		246-083-002-022G	SWP-D-C	T1: 3
03.00 → 09.01	AJM		246-086-001-002C	HLWP	T1: 3
03.00 → 09.01	AJM		246-086-001-007C	HLWP	T1: 3b; T3: X11-246-003-014

1.9 TDI quattro (85 kW | 1.9 Liter)

03.00 → 09.01	AJM / ATJ		246-086-001-007C	HLWP	T1: 3b; T3: X11-246-003-014
---------------	-----------	--	------------------	------	--------------------------------



			VDO		
Datum	Motorcode	Fahrgestell Nr.	Artikel Nr.	Artikelbez.	Information

AUDI**A4 Avant (8D5, B5)****2.5 TDI (110 kW | 2.5 Liter)**

11.97 → 07.99	AFB / AKN		246-082-008-025G	SWP-M-C	T1: 3
11.97 → 07.99	AFB / AKN		246-083-002-022G	SWP-D-C	T1: 3
11.97 → 07.99	AFB / AKN		246-086-001-002C	HLWP	T1: 3
09.97 → 09.01	AFB / AKN		246-086-001-007C	HLWP	T1: 3b; T3: X11-246-003-014

2.5 TDI quattro (110 kW | 2.5 Liter)

11.97 → 07.99	AFB / AKN		246-082-008-025G	SWP-M-C	T1: 3
11.97 → 07.99	AFB / AKN		246-083-002-022G	SWP-D-C	T1: 3
11.97 → 07.99	AFB / AKN		246-086-001-002C	HLWP	T1: 3
09.97 → 09.01	AFB / AKN		246-086-001-007C	HLWP	T1: 3b; T3: X11-246-003-014

A4 (8E2, B6)**1.6 (75 kW | 1.6 Liter)**

11.00 →	ALZ		246-086-001-007C	HLWP	T1: 3b; T3: X11-246-003-014
---------	-----	--	------------------	------	--------------------------------

1.8 T (110 kW | 1.8 Liter)

11.00 → 07.02	AVJ		246-086-001-007C	HLWP	T1: 3b; T3: X11-246-003-014
---------------	-----	--	------------------	------	--------------------------------

1.8 T quattro (110 kW | 1.8 Liter)

11.00 → 07.02	AVJ		246-086-001-007C	HLWP	T1: 3b; T3: X11-246-003-014
---------------	-----	--	------------------	------	--------------------------------

1.8 T (120 kW | 1.8 Liter)

07.02 →	BFB	8E-1000 001 →; → 8E-5-400 000	246-082-008-025G	SWP-M-C	T1: 3
07.02 →	BFB	8E-1000 001 →; → 8E-5-400 000	246-083-002-022G	SWP-D-C	T1: 3

1.8 T quattro (120 kW | 1.8 Liter)

07.02 →	BFB	8E-1000 001 →; → 8E-5-400 000	246-082-008-025G	SWP-M-C	T1: 3
07.02 →	BFB	8E-1000 001 →; → 8E-5-400 000	246-083-002-022G	SWP-D-C	T1: 3

1.8 T (125 kW | 1.8 Liter)

07.01 →	AMB	8E-1000 001 →; → 8E-5-400 000	246-082-008-025G	SWP-M-C	T1: 3
07.01 →	AMB	8E-1000 001 →; → 8E-5-400 000	246-083-002-022G	SWP-D-C	T1: 3

1.8 T quattro (125 kW | 1.8 Liter)

07.01 →	AMB	8E-1000 001 →; → 8E-5-400 000	246-082-008-025G	SWP-M-C	T1: 3
07.01 →	AMB	8E-1000 001 →; → 8E-5-400 000	246-083-002-022G	SWP-D-C	T1: 3



			VDO		
Datum	Motorcode	Fahrgestell Nr.	Artikel Nr.	Artikelbez.	Information

AUDI**A4 (8E2, B6)****1.8 T (140 kW | 1.8 Liter)**

11.02 →	BEX	8E-1000 001 →; → 8E-5-400 000	246-082-008-025G	SWP-M-C	T1: 3
11.02 →	BEX	8E-1000 001 →; → 8E-5-400 000	246-083-002-022G	SWP-D-C	T1: 3

1.8 T quattro (140 kW | 1.8 Liter)

11.02 →	BEX	8E-1000 001 →; → 8E-5-400 000	246-082-008-025G	SWP-M-C	T1: 3
11.02 →	BEX	8E-1000 001 →; → 8E-5-400 000	246-083-002-022G	SWP-D-C	T1: 3

2.0 (96 kW | 2.0 Liter)

11.00 →	ALT		246-086-001-007C	HLWP	T1: 3b; T3: X11-246-003-014
---------	-----	--	------------------	------	--------------------------------

2.0 FSI (110 kW | 2.0 Liter)

07.02 →	AWA		246-086-001-007C	HLWP	T1: 3b; T3: X11-246-003-014
---------	-----	--	------------------	------	--------------------------------

2.4 (120 kW | 2.4 Liter)

09.01 →	AMM	8E-1000 001 →; → 8E-5-400 000	246-082-008-025G	SWP-M-C	T1: 3
09.01 →	AMM	8E-1000 001 →; → 8E-5-400 000	246-083-002-022G	SWP-D-C	T1: 3

2.4 (125 kW | 2.4 Liter)

09.01 →	BDV		246-086-001-007C	HLWP	T1: 3b; T3: X11-246-003-014
---------	-----	--	------------------	------	--------------------------------

3.0 (160 kW | 3.0 Liter)

04.01 →	BBJ	8E-1000 001 →; → 8E-5-400 000	246-082-008-025G	SWP-M-C	T1: 3
04.01 →	BBJ	8E-1000 001 →; → 8E-5-400 000	246-083-002-022G	SWP-D-C	T1: 3

3.0 quattro (160 kW | 3.0 Liter)

04.01 →	BBJ	8E-1000 001 →; → 8E-5-400 000	246-082-008-025G	SWP-M-C	T1: 3
04.01 →	BBJ	8E-1000 001 →; → 8E-5-400 000	246-083-002-022G	SWP-D-C	T1: 3

3.0 (162 kW | 3.0 Liter)

11.00 →	ASN / AVK		246-086-001-007C	HLWP	T1: 3b; T3: X11-246-003-014
---------	-----------	--	------------------	------	--------------------------------

3.0 quattro (162 kW | 3.0 Liter)

11.00 →	ASN / AVK		246-086-001-007C	HLWP	T1: 3b; T3: X11-246-003-014
---------	-----------	--	------------------	------	--------------------------------

S4 quattro (253 kW | 4.2 Liter)

03.03 →	BBK		246-082-008-025G	SWP-M-C	T1: 3
03.03 →	BBK		246-083-002-022G	SWP-D-C	T1: 3



			VDO		
Datum	Motorcode	Fahrgestell Nr.	Artikel Nr.	Artikelbez.	Information

AUDI

A4 (8E2, B6)

1.9 TDI (74 kW | 1.9 Liter)

05.01 →	AVB		246-086-001-007C	HLWP	T1: 3b; T3: X11-246-003-014
---------	-----	--	------------------	------	--------------------------------

1.9 TDI (85 kW | 1.9 Liter)

06.04 →	BKE	8E-1000 001 →; → 8E-5-400 000	246-082-008-025G	SWP-M-C	T1: 3
---------	-----	----------------------------------	------------------	---------	-------

06.04 →	BKE	8E-1000 001 →; → 8E-5-400 000	246-083-002-022G	SWP-D-C	T1: 3
---------	-----	----------------------------------	------------------	---------	-------

1.9 TDI (96 kW | 1.9 Liter)

11.00 →	AVF / AWX		246-086-001-007C	HLWP	T1: 3b; T3: X11-246-003-014
---------	-----------	--	------------------	------	--------------------------------

1.9 TDI quattro (96 kW | 1.9 Liter)

11.01 →	AVF		246-086-001-007C	HLWP	T1: 3b; T3: X11-246-003-014
---------	-----	--	------------------	------	--------------------------------

2.5 TDI (114 kW | 2.5 Liter)

08.01 → 07.02	AYM		246-086-001-007C	HLWP	T1: 3b; T3: X11-246-003-014
---------------	-----	--	------------------	------	--------------------------------

2.5 TDI (120 kW | 2.5 Liter)

07.02 →	BCZ / BDG / BFC	8E-1000 001 →; → 8E-5-400 000	246-082-008-025G	SWP-M-C	T1: 3
---------	-----------------	----------------------------------	------------------	---------	-------

07.02 →	BCZ / BDG / BFC	8E-1000 001 →; → 8E-5-400 000	246-083-002-022G	SWP-D-C	T1: 3
---------	-----------------	----------------------------------	------------------	---------	-------

2.5 TDI quattro (132 kW | 2.5 Liter)

11.00 →	AKE / BAU / BDH		246-086-001-007C	HLWP	T1: 3b; T3: X11-246-003-014
---------	-----------------	--	------------------	------	--------------------------------

A4 Avant (8E5, B6)

1.6 (75 kW | 1.6 Liter)

09.01 →	ALZ		246-086-001-007C	HLWP	T1: 3b; T3: X11-246-003-014
---------	-----	--	------------------	------	--------------------------------

1.8 T (110 kW | 1.8 Liter)

09.01 → 07.02	AVJ		246-086-001-007C	HLWP	T1: 3b; T3: X11-246-003-014
---------------	-----	--	------------------	------	--------------------------------

1.8 T quattro (110 kW | 1.8 Liter)

09.01 → 07.02	AVJ		246-086-001-007C	HLWP	T1: 3b; T3: X11-246-003-014
---------------	-----	--	------------------	------	--------------------------------





1.8 T (120 kW | 1.8 Liter)

07.02 →	BFB	8E-1000 001 →; → 8E-5-400 000	246-083-002-022G	SWP-D-C	T1: 3
---------	-----	----------------------------------	------------------	---------	-------

1.8 T quattro (120 kW | 1.8 Liter)

07.02 →	BFB	8E-1000 001 →; → 8E-5-400 000	246-083-002-022G	SWP-D-C	T1: 3
---------	-----	----------------------------------	------------------	---------	-------



			VDO		
Datum	Motorcode	Fahrgestell Nr.	Artikel Nr.	Artikelbez.	Information

AUDI**A4 Avant (8E5, B6)****1.8 T quattro (125 kW | 1.8 Liter)**

09.01 →	AMB	8E-1000 001 →; → 8E-5-400 000	246-083-002-022G	SWP-D-C	T1: 3
---------	-----	----------------------------------	------------------	---------	-------

1.8 T (140 kW | 1.8 Liter)

11.02 →	BEX	8E-1000 001 →; → 8E-5-400 000	246-083-002-022G	SWP-D-C	T1: 3
---------	-----	----------------------------------	------------------	---------	-------

1.8 T quattro (140 kW | 1.8 Liter)

11.02 →	BEX	8E-1000 001 →; → 8E-5-400 000	246-083-002-022G	SWP-D-C	T1: 3
---------	-----	----------------------------------	------------------	---------	-------

2.0 (96 kW | 2.0 Liter)

09.01 →	ALT		246-086-001-007C	HLWP	T1: 3b; T3: X11-246-003-014
---------	-----	--	------------------	------	--------------------------------

2.0 FSI (110 kW | 2.0 Liter)

07.02 →	AWA	8E-1000 001 →; → 8E-5-400 000	246-083-002-022G	SWP-D-C	T1: 3
---------	-----	----------------------------------	------------------	---------	-------

2.4 (120 kW | 2.4 Liter)

09.01 →	AMM	8E-1000 001 →; → 8E-5-400 000	246-083-002-022G	SWP-D-C	T1: 3
---------	-----	----------------------------------	------------------	---------	-------

2.4 (125 kW | 2.4 Liter)

09.01 →	BDV		246-086-001-007C	HLWP	T1: 3b; T3: X11-246-003-014
---------	-----	--	------------------	------	--------------------------------

3.0 (160 kW | 3.0 Liter)

04.01 →	BBJ	8E-1000 001 →; → 8E-5-400 000	246-083-002-022G	SWP-D-C	T1: 3
---------	-----	----------------------------------	------------------	---------	-------

3.0 quattro (160 kW | 3.0 Liter)

04.01 →	BBJ	8E-1000 001 →; → 8E-5-400 000	246-083-002-022G	SWP-D-C	T1: 3
---------	-----	----------------------------------	------------------	---------	-------

3.0 (162 kW | 3.0 Liter)

09.01 →	ASN		246-086-001-007C	HLWP	T1: 3b; T3: X11-246-003-014
---------	-----	--	------------------	------	--------------------------------

3.0 quattro (162 kW | 3.0 Liter)

09.01 →	ASN / AVK		246-086-001-007C	HLWP	T1: 3b; T3: X11-246-003-014
---------	-----------	--	------------------	------	--------------------------------

S4 quattro (253 kW | 4.2 Liter)

03.03 →	BBK		246-082-008-025G	SWP-M-C	T1: 3
---------	-----	--	------------------	---------	-------

03.03 →	BBK	8E-1000 001 →; → 8E-5-400 000	246-083-002-022G	SWP-D-C	T1: 3
---------	-----	----------------------------------	------------------	---------	-------

1.9 TDI (74 kW | 1.9 Liter)

11.01 →	AVB		246-086-001-007C	HLWP	T1: 3b; T3: X11-246-003-014
---------	-----	--	------------------	------	--------------------------------

1.9 TDI (85 kW | 1.9 Liter)

06.04 →	BKE	8E-1000 001 →; → 8E-5-400 000	246-083-002-022G	SWP-D-C	T1: 3
---------	-----	----------------------------------	------------------	---------	-------



			VDO		
Datum	Motorcode	Fahrgestell Nr.	Artikel Nr.	Artikelbez.	Information

AUDI

A4 Avant (8E5, B6)

1.9 TDI (96 kW | 1.9 Liter)

09.01 →	AVF / AWX		246-086-001-007C	HLWP	T1: 3b; T3: X11-246-003-014
---------	-----------	--	------------------	------	--------------------------------

1.9 TDI quattro (96 kW | 1.9 Liter)

11.01 →	AVF		246-086-001-007C	HLWP	T1: 3b; T3: X11-246-003-014
---------	-----	--	------------------	------	--------------------------------

2.5 TDI (114 kW | 2.5 Liter)

09.01 → 07.02	AYM		246-086-001-007C	HLWP	T1: 3b; T3: X11-246-003-014
---------------	-----	--	------------------	------	--------------------------------

2.5 TDI (120 kW | 2.5 Liter)

07.02 →	BCZ / BDG / BFC	8E-1000 001 →; → 8E-5-400 000	246-083-002-022G	SWP-D-C	T1: 3
---------	-----------------	----------------------------------	------------------	---------	-------

2.5 TDI quattro (132 kW | 2.5 Liter)

09.01 →	AKE / BAU / BDH		246-086-001-007C	HLWP	T1: 3b; T3: X11-246-003-014
---------	-----------------	--	------------------	------	--------------------------------

A4 Cabriolet (8H7)

1.8 T (120 kW | 1.8 Liter)

07.02 →	BFB		246-082-008-025G	SWP-M-C	T1: 3
07.02 →	BFB		246-086-001-007C	HLWP	T1: 3b

1.8 T quattro (120 kW | 1.8 Liter)

05.03 →	BFB		246-082-008-025G	SWP-M-C	T1: 3
---------	-----	--	------------------	---------	-------

2.0 (96 kW | 2.0 Liter)

09.04 →	ALT		246-082-008-025G	SWP-M-C	T1: 3
---------	-----	--	------------------	---------	-------

2.4 (120 kW | 2.4 Liter)

04.02 →	AMM		246-082-008-025G	SWP-M-C	T1: 3
04.02 →	AMM		246-086-001-007C	HLWP	T1: 3b

2.4 (125 kW | 2.4 Liter)

04.02 →	BDV		246-082-008-025G	SWP-M-C	T1: 3
04.02 →	BDV		246-086-001-007C	HLWP	T1: 3b

3.0 (162 kW | 3.0 Liter)

04.02 →	ASN		246-082-008-025G	SWP-M-C	T1: 3
04.02 →	ASN		246-086-001-007C	HLWP	T1: 3b

3.0 quattro (162 kW | 3.0 Liter)

05.03 →	ASN		246-082-008-025G	SWP-M-C	T1: 3
---------	-----	--	------------------	---------	-------





S4 quattro (253 kW | 4.2 Liter)

03.04 →	BBK		246-082-008-025G	SWP-M-C	T1: 3
---------	-----	--	------------------	---------	-------

2.5 TDI (120 kW | 2.5 Liter)

08.02 →	BCZ / BDG / BFC		246-082-008-025G	SWP-M-C	T1: 3
08.02 →	BCZ / BDG / BFC		246-086-001-007C	HLWP	T1: 3b



			VDO		
Datum	Motorcode	Fahrgestell Nr.	Artikel Nr.	Artikelbez.	Information

AUDI**A4 (8EC)****1.6 (75 kW | 1.6 Liter)**

11.04 → ALZ 8E-5-400 001 → 246-082-008-025G SWP-M-C T1: 3

11.04 → ALZ 8E-5-400 001 → 246-083-002-022G SWP-D-C T1: 3

1.8 T (120 kW | 1.8 Liter)

11.04 → BFB 8E-5-400 001 → 246-082-008-025G SWP-M-C T1: 3

11.04 → BFB 8E-5-400 001 → 246-083-002-022G SWP-D-C T1: 3

1.8 T quattro (120 kW | 1.8 Liter)

11.04 → BFB 8E-5-400 001 → 246-082-008-025G SWP-M-C T1: 3

11.04 → BFB 8E-5-400 001 → 246-083-002-022G SWP-D-C T1: 3

2.0 (96 kW | 2.0 Liter)

11.04 → ALT 8E-5-400 001 → 246-082-008-025G SWP-M-C T1: 3

11.04 → ALT 8E-5-400 001 → 246-083-002-022G SWP-D-C T1: 3

2.0 TFSI (147 kW | 2.0 Liter)

11.04 → BGB 8E-5-400 001 → 246-082-008-025G SWP-M-C T1: 3

11.04 → BGB 8E-5-400 001 → 246-083-002-022G SWP-D-C T1: 3

2.0 TFSI quattro (147 kW | 2.0 Liter)

11.04 → BGB 8E-5-400 001 → 246-082-008-025G SWP-M-C T1: 3

11.04 → BGB 8E-5-400 001 → 246-083-002-022G SWP-D-C T1: 3

2.0 TFSI (162 kW | 2.0 Liter)

06.05 → BUL 8E-5-400 001 → 246-082-008-025G SWP-M-C T1: 3

06.05 → BUL 8E-5-400 001 → 246-083-002-022G SWP-D-C T1: 3

2.0 TFSI quattro (162 kW | 2.0 Liter)

06.05 → BUL 8E-5-400 001 → 246-082-008-025G SWP-M-C T1: 3

06.05 → BUL 8E-5-400 001 → 246-083-002-022G SWP-D-C T1: 3

3.2 FSI (188 kW | 3.2 Liter)

01.05 → AUK 8E-5-400 001 → 246-082-008-025G SWP-M-C T1: 3

01.05 → AUK 8E-5-400 001 → 246-083-002-022G SWP-D-C T1: 3

3.2 FSI quattro (188 kW | 3.2 Liter)

01.05 → AUK 8E-5-400 001 → 246-082-008-025G SWP-M-C T1: 3

01.05 → AUK 8E-5-400 001 → 246-083-002-022G SWP-D-C T1: 3

RS4 quattro (309 kW | 4.2 Liter)

09.05 → 8E-5-400 001 → 246-082-008-025G SWP-M-C T1: 3

09.05 → 8E-5-400 001 → 246-083-002-022G SWP-D-C T1: 3

1.9 TDI (85 kW | 1.9 Liter)

11.04 → BKE 8E-5-400 001 → 246-082-008-025G SWP-M-C T1: 3

11.04 → BKE 8E-5-400 001 → 246-083-002-022G SWP-D-C T1: 3

2.0 TDI (100 kW | 2.0 Liter)

11.04 → BNA 8E-5-400 001 → 246-082-008-025G SWP-M-C T1: 3

11.04 → BNA 8E-5-400 001 → 246-083-002-022G SWP-D-C T1: 3

2.0 TDI (103 kW | 2.0 Liter)

11.04 → BLB / BPW 8E-5-400 001 → 246-082-008-025G SWP-M-C T1: 3

11.04 → BLB / BPW 8E-5-400 001 → 246-083-002-022G SWP-D-C T1: 3

2.5 TDI (120 kW | 2.5 Liter)

11.04 → BCZ / BDG 8E-5-400 001 → 246-082-008-025G SWP-M-C T1: 3

11.04 → BCZ / BDG 8E-5-400 001 → 246-083-002-022G SWP-D-C T1: 3



			VDO		
Datum	Motorcode	Fahrgestell Nr.	Artikel Nr.	Artikelbez.	Information

AUDI**A4 (8EC)****3.0 TDI quattro (150 kW | 3.0 Liter)**

11.04 →	BKN	8E-5-400 001 →	246-082-008-025G	SWP-M-C	T1: 3
11.04 →	BKN	8E-5-400 001 →	246-083-002-022G	SWP-D-C	T1: 3

A4 Avant (8ED)**1.6 (75 kW | 1.6 Liter)**

11.04 →	ALZ	8E-5-400 001 →	246-083-002-022G	SWP-D-C	T1: 3
---------	-----	----------------	------------------	---------	-------

1.8 T (120 kW | 1.8 Liter)

11.04 →	BFB		246-083-002-022G	SWP-D-C	T1: 3
---------	-----	--	------------------	---------	-------

1.8 T quattro (120 kW | 1.8 Liter)

11.04 →	BFB		246-083-002-022G	SWP-D-C	T1: 3
---------	-----	--	------------------	---------	-------

2.0 (96 kW | 2.0 Liter)

11.04 →	ALT		246-083-002-022G	SWP-D-C	T1: 3
---------	-----	--	------------------	---------	-------

2.0 TFSI (147 kW | 2.0 Liter)

11.04 →	BGB		246-083-002-022G	SWP-D-C	T1: 3
---------	-----	--	------------------	---------	-------

2.0 TFSI quattro (147 kW | 2.0 Liter)

11.04 →	BGB		246-083-002-022G	SWP-D-C	T1: 3
---------	-----	--	------------------	---------	-------

3.2 FSI (188 kW | 3.2 Liter)

01.05 →	AUK		246-083-002-022G	SWP-D-C	T1: 3
---------	-----	--	------------------	---------	-------

3.2 FSI quattro (188 kW | 3.2 Liter)

01.05 →	AUK		246-083-002-022G	SWP-D-C	T1: 3
---------	-----	--	------------------	---------	-------

1.9 TDI (85 kW | 1.9 Liter)

11.04 →	BKE		246-083-002-022G	SWP-D-C	T1: 3
---------	-----	--	------------------	---------	-------

2.0 TDI (103 kW | 2.0 Liter)

11.04 →	BLB		246-083-002-022G	SWP-D-C	T1: 3
---------	-----	--	------------------	---------	-------

2.5 TDI (120 kW | 2.5 Liter)

11.04 →	BCZ / BDG		246-083-002-022G	SWP-D-C	T1: 3
---------	-----------	--	------------------	---------	-------

3.0 TDI quattro (150 kW | 3.0 Liter)

11.04 →	BKN		246-083-002-022G	SWP-D-C	T1: 3
---------	-----	--	------------------	---------	-------

A6 (4A, C4)**1.8 (92 kW | 1.8 Liter)**

12.95 → 02.97	ADR		246-082-008-014C	SWP-M-C	T1: 1
---------------	-----	--	------------------	---------	-------

1.8 quattro (92 kW | 1.8 Liter)

12.95 → 02.97	ADR		246-082-008-014C	SWP-M-C	T1: 1
---------------	-----	--	------------------	---------	-------

12.95 → 02.97	ADR		246-086-001-002C	HLWP	T1: 3
---------------	-----	--	------------------	------	-------

2.0 (74 kW | 2.0 Liter)

06.94 → 02.97	AAE		246-082-008-014C	SWP-M-C	T1: 1
---------------	-----	--	------------------	---------	-------





2.0 (85 kW | 2.0 Liter)

06.94 → 02.97	ABK		246-082-008-014C	SWP-M-C	T1: 1
---------------	-----	--	------------------	---------	-------

2.0 16V (103 kW | 2.0 Liter)

06.94 → 02.97	ACE		246-082-008-014C	SWP-M-C	T1: 1
---------------	-----	--	------------------	---------	-------



			VDO		
Datum	Motorcode	Fahrgestell Nr.	Artikel Nr.	Artikelbez.	Information

AUDI**A6 (4A, C4)****2.0 16V quattro (103 kW | 2.0 Liter)**

06.94 → 02.97	ACE		246-082-008-014C	SWP-M-C	T1: 1
---------------	-----	--	------------------	---------	-------

06.94 → 02.97	ACE		246-086-001-002C	HLWP	T1: 3
---------------	-----	--	------------------	------	-------

2.3 (98 kW | 2.3 Liter)

06.94 → 12.95	AAR		246-082-008-014C	SWP-M-C	T1: 1
---------------	-----	--	------------------	---------	-------

2.3 quattro (98 kW | 2.3 Liter)

08.94 → 12.95	AAR		246-082-008-014C	SWP-M-C	T1: 1
---------------	-----	--	------------------	---------	-------

08.94 → 12.95	AAR		246-086-001-002C	HLWP	T1: 3
---------------	-----	--	------------------	------	-------

2.6 (102 kW | 2.6 Liter)

06.94 → 02.97	ACZ		246-082-008-014C	SWP-M-C	T1: 1
---------------	-----	--	------------------	---------	-------

2.6 (110 kW | 2.6 Liter)

06.94 → 02.97	ABC		246-082-008-014C	SWP-M-C	T1: 1
---------------	-----	--	------------------	---------	-------

2.6 quattro (110 kW | 2.6 Liter)

06.94 → 02.97	ABC		246-082-008-014C	SWP-M-C	T1: 1
---------------	-----	--	------------------	---------	-------

06.94 → 02.97	ABC		246-086-001-002C	HLWP	T1: 3
---------------	-----	--	------------------	------	-------

2.8 (128 kW | 2.8 Liter)

06.94 → 02.97	AAH / AEJ		246-082-008-014C	SWP-M-C	T1: 1
---------------	-----------	--	------------------	---------	-------

2.8 quattro (128 kW | 2.8 Liter)

07.94 → 02.97	AAH / AEJ		246-082-008-014C	SWP-M-C	T1: 1
---------------	-----------	--	------------------	---------	-------

07.94 → 02.97	AAH / AEJ		246-086-001-002C	HLWP	T1: 3
---------------	-----------	--	------------------	------	-------

2.8 (142 kW | 2.8 Liter)

12.95 → 02.97	ACK		246-082-008-014C	SWP-M-C	T1: 1
---------------	-----	--	------------------	---------	-------

2.8 quattro (142 kW | 2.8 Liter)

12.95 → 02.97	ACK		246-082-008-014C	SWP-M-C	T1: 1
---------------	-----	--	------------------	---------	-------

12.95 → 02.97	ACK		246-086-001-002C	HLWP	T1: 3
---------------	-----	--	------------------	------	-------

S6 Turbo quattro (169 kW | 2.2 Liter)

07.94 → 02.97	AAN		246-086-001-002C	HLWP	T1: 3
---------------	-----	--	------------------	------	-------

S6 4.2 quattro (213 kW | 4.2 Liter)

07.94 → 02.97	AEC		246-086-001-002C	HLWP	T1: 3
---------------	-----	--	------------------	------	-------

S6 Plus quattro (240 kW | 4.2 Liter)

06.96 → 02.97	AHK		246-086-001-002C	HLWP	T1: 3
---------------	-----	--	------------------	------	-------

1.9 TDI (66 kW | 1.9 Liter)

06.94 → 02.97	1Z / AHU		246-082-008-014C	SWP-M-C	T1: 1
---------------	----------	--	------------------	---------	-------

2.5 TDI (84 kW | 2.5 Liter)

01.95 → 02.97	AAT		246-082-008-014C	SWP-M-C	T1: 1
---------------	-----	--	------------------	---------	-------

2.5 TDI (85 kW | 2.5 Liter)

06.94 → 02.97	AAT		246-082-008-014C	SWP-M-C	T1: 1
---------------	-----	--	------------------	---------	-------

2.5 TDI (103 kW | 2.5 Liter)

08.94 → 02.97	AEL		246-082-008-014C	SWP-M-C	T1: 1
---------------	-----	--	------------------	---------	-------

2.5 TDI quattro (103 kW | 2.5 Liter)

10.95 → 02.97	AEL		246-082-008-014C	SWP-M-C	T1: 1
---------------	-----	--	------------------	---------	-------

10.95 → 02.97	AEL		246-086-001-002C	HLWP	T1: 3
---------------	-----	--	------------------	------	-------



			VDO		
Datum	Motorcode	Fahrgestell Nr.	Artikel Nr.	Artikelbez.	Information

AUDI**A6 Avant (4A, C4)****1.8 (92 kW | 1.8 Liter)**

12.95 → 09.97	ADR		246-082-008-014C	SWP-M-C	T1: 1
---------------	-----	--	------------------	---------	-------

1.8 quattro (92 kW | 1.8 Liter)

12.95 → 09.97	ADR		246-082-008-014C	SWP-M-C	T1: 1
---------------	-----	--	------------------	---------	-------

12.95 → 09.97	ADR		246-086-001-002C	HLWP	T1: 3
---------------	-----	--	------------------	------	-------

2.0 (74 kW | 2.0 Liter)

07.94 → 09.97	AAE		246-082-008-014C	SWP-M-C	T1: 1
---------------	-----	--	------------------	---------	-------

2.0 (85 kW | 2.0 Liter)

06.94 → 12.97	ABK		246-082-008-014C	SWP-M-C	T1: 1
---------------	-----	--	------------------	---------	-------

2.0 16V (103 kW | 2.0 Liter)

07.94 → 09.97	ACE		246-082-008-014C	SWP-M-C	T1: 1
---------------	-----	--	------------------	---------	-------

2.0 16V quattro (103 kW | 2.0 Liter)

06.94 → 09.97	ACE		246-082-008-014C	SWP-M-C	T1: 1
---------------	-----	--	------------------	---------	-------

06.94 → 09.97	ACE		246-086-001-002C	HLWP	T1: 3
---------------	-----	--	------------------	------	-------

2.3 (98 kW | 2.3 Liter)

07.94 → 12.95	AAR		246-082-008-014C	SWP-M-C	T1: 1
---------------	-----	--	------------------	---------	-------

2.3 quattro (98 kW | 2.3 Liter)

08.94 → 12.95	AAR		246-082-008-014C	SWP-M-C	T1: 1
---------------	-----	--	------------------	---------	-------

08.94 → 12.95	AAR		246-086-001-002C	HLWP	T1: 3
---------------	-----	--	------------------	------	-------

2.6 (102 kW | 2.6 Liter)

06.94 → 02.97	ACZ		246-082-008-014C	SWP-M-C	T1: 1
---------------	-----	--	------------------	---------	-------

2.6 (110 kW | 2.6 Liter)

07.94 → 09.97	ABC		246-082-008-014C	SWP-M-C	T1: 1
---------------	-----	--	------------------	---------	-------

2.6 quattro (110 kW | 2.6 Liter)

06.94 → 09.97	ABC		246-082-008-014C	SWP-M-C	T1: 1
---------------	-----	--	------------------	---------	-------

06.94 → 09.97	ABC		246-086-001-002C	HLWP	T1: 3
---------------	-----	--	------------------	------	-------

2.8 (128 kW | 2.8 Liter)

07.94 → 09.97	AAH / AEJ		246-082-008-014C	SWP-M-C	T1: 1
---------------	-----------	--	------------------	---------	-------

2.8 quattro (128 kW | 2.8 Liter)

06.94 → 09.97	AAH / AEJ		246-082-008-014C	SWP-M-C	T1: 1
---------------	-----------	--	------------------	---------	-------

06.94 → 09.97	AAH / AEJ		246-086-001-002C	HLWP	T1: 3
---------------	-----------	--	------------------	------	-------

2.8 (142 kW | 2.8 Liter)

12.95 → 09.97	ACK		246-082-008-014C	SWP-M-C	T1: 1
---------------	-----	--	------------------	---------	-------

2.8 quattro (142 kW | 2.8 Liter)

12.95 → 09.97	ACK		246-082-008-014C	SWP-M-C	T1: 1
---------------	-----	--	------------------	---------	-------

12.95 → 12.97	ACK		246-086-001-002C	HLWP	T1: 3
---------------	-----	--	------------------	------	-------

S6 Turbo quattro (169 kW | 2.2 Liter)

07.94 → 12.97	AAN		246-082-008-014C	SWP-M-C	T1: 1
---------------	-----	--	------------------	---------	-------

07.94 → 12.97	AAN		246-086-001-002C	HLWP	T1: 3
---------------	-----	--	------------------	------	-------

S6 4.2 quattro (213 kW | 4.2 Liter)

07.94 → 12.97	AEC		246-082-008-014C	SWP-M-C	T1: 1
---------------	-----	--	------------------	---------	-------

07.94 → 12.97	AEC		246-086-001-002C	HLWP	T1: 3
---------------	-----	--	------------------	------	-------

S6 Plus quattro (240 kW | 4.2 Liter)

06.96 → 12.97	AHK		246-082-008-014C	SWP-M-C	T1: 1
---------------	-----	--	------------------	---------	-------

06.96 → 12.97	AHK		246-086-001-002C	HLWP	T1: 3
---------------	-----	--	------------------	------	-------



			VDO		
Datum	Motorcode	Fahrgestell Nr.	Artikel Nr.	Artikelbez.	Information

AUDI**A6 Avant (4A, C4)****1.9 TDI (66 kW | 1.9 Liter)**

07.94 → 09.97 1Z / AHU 246-082-008-014C SWP-M-C T1: 1

2.5 TDI (84 kW | 2.5 Liter)

01.95 → 09.97 AAT 246-082-008-014C SWP-M-C T1: 1

2.5 TDI (85 kW | 2.5 Liter)

06.94 → 12.97 AAT 246-082-008-014C SWP-M-C T1: 1

2.5 TDI (103 kW | 2.5 Liter)

08.94 → 09.97 AEL 246-082-008-014C SWP-M-C T1: 1

2.5 TDI quattro (103 kW | 2.5 Liter)

07.95 → 09.97 AEL 246-082-008-014C SWP-M-C T1: 1

07.95 → 09.97 AEL 246-086-001-002C HLWP T1: 3

A6 (4B, C5)**1.8 (85 kW | 1.8 Liter)**

05.97 → 04.99 AFY 246-082-008-025G SWP-M-C T1: 3

05.97 → 04.99 AFY 246-086-001-002C HLWP T1: 3

05.97 → AFY 246-086-001-007C HLWP T1: 3b; T3:
X11-246-003-014**1.8 (92 kW | 1.8 Liter)**

12.97 → 07.99 AJP / AQE / ARH 246-082-008-025G SWP-M-C T1: 3

12.97 → 07.99 AJP / AQE / ARH 246-086-001-002C HLWP T1: 3

07.97 → AJP / AQE / ARH 246-086-001-007C HLWP T1: 3b; T3:
X11-246-003-014**1.8 T (110 kW | 1.8 Liter)**

04.97 → 06.99 AEB / ANB / APU / ARK / AWT 246-082-008-025G SWP-M-C T1: 3

04.97 → 06.99 AEB / ANB / APU / ARK / AWT 246-086-001-002C HLWP T1: 3

01.97 → AEB / ANB / APU / ARK / AWT 246-086-001-007C HLWP T1: 3b; T3:
X11-246-003-014**1.8 T quattro (110 kW | 1.8 Liter)**

04.97 → 06.99 AEB / ANB / APU / ARK / AWT 246-082-008-025G SWP-M-C T1: 3

04.97 → 06.99 AEB / ANB / APU / ARK / AWT 246-086-001-002C HLWP T1: 3

02.97 → AEB / ANB / APU / ARK / AWT 246-086-001-007C HLWP T1: 3b; T3:
X11-246-003-014**1.8 T (132 kW | 1.8 Liter)**

12.97 → 07.98 AJL 246-082-008-025G SWP-M-C T1: 3

12.97 → 07.98 AJL 246-086-001-002C HLWP T1: 3

12.97 → AJL 246-086-001-007C HLWP T1: 3b; T3:
X11-246-003-014**1.8 T quattro (132 kW | 1.8 Liter)**

12.97 → 07.98 AJL 246-082-008-025G SWP-M-C T1: 3

12.97 → 07.98 AJL 246-086-001-002C HLWP T1: 3

12.97 → AJL 246-086-001-007C HLWP T1: 3b; T3:
X11-246-003-014







			VDO		
Datum	Motorcode	Fahrgestell Nr.	Artikel Nr.	Artikelbez.	Information

AUDI**A6 (4B, C5)**

2.0 (96 kW 2.0 Liter)					
08.01 →	ALT		246-086-001-007C	HLWP	T1: 3b; T3: X11-246-003-014
2.4 (100 kW 2.4 Liter)					
07.98 → 01.99	ALW / ARN / ASM		246-082-008-025G	SWP-M-C	T1: 3
07.98 → 01.99	ALW / ARN / ASM		246-086-001-002C	HLWP	T1: 3
07.98 →	ALW / ARN / ASM		246-086-001-007C	HLWP	T1: 3b; T3: X11-246-003-014
2.4 (115 kW 2.4 Liter)					
02.97 →	APC		246-086-001-007C	HLWP	T1: 3b; T3: X11-246-003-014
2.4 quattro (115 kW 2.4 Liter)					
08.98 → 07.99	APC		246-082-008-025G	SWP-M-C	T1: 3
08.98 → 07.99	APC		246-083-002-022G	SWP-D-C	T1: 3
2.4 (120 kW 2.4 Liter)					
02.97 →	AJG / AMM / APZ		246-086-001-007C	HLWP	T1: 3b; T3: X11-246-003-014
2.4 quattro (120 kW 2.4 Liter)					
02.97 →	AJG / APZ		246-086-001-007C	HLWP	T1: 3b; T3: X11-246-003-014
2.4 (121 kW 2.4 Liter)					
04.97 → 07.99	AGA / ALF / AML / APS / ARJ		246-082-008-025G	SWP-M-C	T1: 3
04.97 → 07.99	AGA / ALF / AML / APS / ARJ		246-086-001-002C	HLWP	T1: 3
02.97 →	AGA / ALF / AML / APS / ARJ		246-086-001-007C	HLWP	T1: 3b; T3: X11-246-003-014
2.4 quattro (121 kW 2.4 Liter)					
04.97 → 07.99	AGA / ALF / AML / APS / ARJ		246-082-008-025G	SWP-M-C	T1: 3
04.97 → 07.99	AGA / ALF / AML / APS / ARJ		246-086-001-002C	HLWP	T1: 3
02.97 →	AGA / ALF / AML / APS / ARJ		246-086-001-007C	HLWP	T1: 3b; T3: X11-246-003-014
2.4 (125 kW 2.4 Liter)					
08.01 →	BDV		246-086-001-007C	HLWP	T1: 3b; T3: X11-246-003-014
2.4 quattro (125 kW 2.4 Liter)					
08.01 →	BDV		246-086-001-007C	HLWP	T1: 3b; T3: X11-246-003-014
2.7 T (169 kW 2.7 Liter)					
02.99 →	AJK		246-082-008-025G	SWP-M-C	T1: 3
02.99 →	AJK		246-086-001-002C	HLWP	T1: 3
02.99 →	AJK		246-086-001-007C	HLWP	T1: 3b; T3: X11-246-003-014



			VDO		
Datum	Motorcode	Fahrgestell Nr.	Artikel Nr.	Artikelbez.	Information

AUDI**A6 (4B, C5)****2.7 T quattro (169 kW | 2.7 Liter)**

03.98 → 07.98	AJK		246-082-008-025G	SWP-M-C	T1: 3
03.98 → 07.98	AJK		246-086-001-002C	HLWP	T1: 3
12.97 →	AJK		246-086-001-007C	HLWP	T1: 3b; T3: X11-246-003-014

2.7 T quattro (184 kW | 2.7 Liter)

08.01 →	ARE / BES		246-086-001-007C	HLWP	T1: 3b; T3: X11-246-003-014
---------	-----------	--	------------------	------	--------------------------------

2.8 (132 kW | 2.8 Liter)

04.98 → 07.98	AGE		246-082-008-025G	SWP-M-C	T1: 3
04.98 → 07.98	AGE		246-086-001-002C	HLWP	T1: 3
10.97 → 07.98	AGE		246-086-001-007C	HLWP	T1: 3b; T3: X11-246-003-014

2.8 (140 kW | 2.8 Liter)

07.99 → 07.99	ATX		246-082-008-025G	SWP-M-C	T1: 3
07.99 → 07.99	ATX		246-086-001-002C	HLWP	T1: 3
07.99 →	ATX		246-086-001-007C	HLWP	T1: 3b; T3: X11-246-003-014

2.8 (142 kW | 2.8 Liter)

04.97 → 07.99	ACK / ALG / AMX / APR / AQD		246-082-008-025G	SWP-M-C	T1: 3
04.97 → 07.99	ACK / ALG / AMX / APR / AQD		246-086-001-002C	HLWP	T1: 3
02.97 →	ACK / ALG / AMX / APR / AQD		246-086-001-007C	HLWP	T1: 3b; T3: X11-246-003-014

2.8 quattro (142 kW | 2.8 Liter)

04.97 → 07.99	ACK / ALG / AMX / APR / AQD		246-082-008-025G	SWP-M-C	T1: 3
04.97 → 07.99	ACK / ALG / AMX / APR / AQD		246-086-001-002C	HLWP	T1: 3
02.97 →	ACK / ALG / AMX / APR / AQD		246-086-001-007C	HLWP	T1: 3b; T3: X11-246-003-014

3.0 (162 kW | 3.0 Liter)

08.01 →	ASN		246-086-001-007C	HLWP	T1: 3b; T3: X11-246-003-014
---------	-----	--	------------------	------	--------------------------------

3.0 quattro (162 kW | 3.0 Liter)

08.01 →	ASN		246-086-001-007C	HLWP	T1: 3b; T3: X11-246-003-014
---------	-----	--	------------------	------	--------------------------------

3.7 (191 kW | 3.7 Liter)

03.99 →			246-086-001-007C	HLWP	T1: 3b; T3: X11-246-003-014
---------	--	--	------------------	------	--------------------------------

3.7 quattro (191 kW | 3.7 Liter)

03.99 →			246-086-001-007C	HLWP	T1: 3b; T3: X11-246-003-014
---------	--	--	------------------	------	--------------------------------

4.2 quattro (220 kW | 4.2 Liter)

04.99 →	ARS / ASG / AWN		246-082-008-025G	SWP-M-C	T1: 3
04.99 →	ARS / ASG / AWN		246-086-001-002C	HLWP	T1: 3
11.98 →	ARS / ASG / AWN		246-086-001-007C	HLWP	T1: 3b; T3: X11-246-003-014



			VDO		
Datum	Motorcode	Fahrgestell Nr.	Artikel Nr.	Artikelbez.	Information

AUDI**A6 (4B, C5)****S6 quattro (250 kW | 4.2 Liter)**

09.99 →	ANK / AQJ		246-086-001-007C	HLWP	T1: 3b; T3: X11-246-003-014
---------	-----------	--	------------------	------	--------------------------------

RS6 (331 kW | 4.2 Liter)

07.02 →	BCY		246-086-001-007C	HLWP	T1: 3b; T3: X11-246-003-014
---------	-----	--	------------------	------	--------------------------------

1.9 TDI (81 kW | 1.9 Liter)

04.97 → 08.99	AFN / AVG		246-082-008-025G	SWP-M-C	T1: 3
04.97 → 08.99	AFN / AVG		246-086-001-002C	HLWP	T1: 3
02.97 →	AFN / AVG		246-086-001-007C	HLWP	T1: 3b; T3: X11-246-003-014

1.9 TDI (85 kW | 1.9 Liter)

07.00 →	AJM		246-082-008-025G	SWP-M-C	T1: 3
07.00 →	AJM		246-086-001-002C	HLWP	T1: 3
07.00 →	AJM		246-086-001-007C	HLWP	T1: 3b; T3: X11-246-003-014

1.9 TDI (96 kW | 1.9 Liter)

08.01 →	AVF / AWX		246-086-001-007C	HLWP	T1: 3b; T3: X11-246-003-014
---------	-----------	--	------------------	------	--------------------------------

2.5 TDI (110 kW | 2.5 Liter)

07.97 → 06.99	AFB / AKN		246-082-008-025G	SWP-M-C	T1: 3
07.97 → 06.99	AFB / AKN		246-086-001-002C	HLWP	T1: 3
07.97 →	AFB / AKN		246-086-001-007C	HLWP	T1: 3b; T3: X11-246-003-014

2.5 TDI quattro (110 kW | 2.5 Liter)

07.97 → 06.99	AFB / AKN		246-082-008-025G	SWP-M-C	T1: 3
07.97 → 06.99	AFB / AKN		246-086-001-002C	HLWP	T1: 3
07.97 →	AFB / AKN		246-086-001-007C	HLWP	T1: 3b; T3: X11-246-003-014

2.5 TDI (114 kW | 2.5 Liter)

08.01 →	AYM		246-086-001-007C	HLWP	T1: 3b; T3: X11-246-003-014
---------	-----	--	------------------	------	--------------------------------

2.5 TDI (120 kW | 2.5 Liter)

07.02 →	BCZ / BDG / BFC		246-082-008-025G	SWP-M-C	T1: 3
07.02 →	BCZ / BDG / BFC		246-083-002-022G	SWP-D-C	T1: 3





2.5 TDI (132 kW | 2.5 Liter)

02.00 →	AKE / BAU / BDH		246-086-001-007C	HLWP	T1: 3b; T3: X11-246-003-014
---------	-----------------	--	------------------	------	--------------------------------

2.5 TDI quattro (132 kW | 2.5 Liter)

02.00 →	AKE / BAU / BDH		246-086-001-007C	HLWP	T1: 3b; T3: X11-246-003-014
---------	-----------------	--	------------------	------	--------------------------------



			VDO		
Datum	Motorcode	Fahrgestell Nr.	Artikel Nr.	Artikelbez.	Information

AUDI**A6 Avant (4B, C5)****1.8 (85 kW | 1.8 Liter)**

02.98 →	AFY		246-083-002-022G	SWP-D-C	T1: 3
02.98 → 04.99	AFY		246-086-001-002C	HLWP	T1: 3
02.98 →	AFY		246-086-001-007C	HLWP	T1: 3b; T3: X11-246-003-014

1.8 (92 kW | 1.8 Liter)

02.98 →	AJP / AQE / ARH		246-083-002-022G	SWP-D-C	T1: 3
02.98 → 07.99	AJP / AQE / ARH		246-086-001-002C	HLWP	T1: 3
12.97 →	AJP / AQE / ARH		246-086-001-007C	HLWP	T1: 3b; T3: X11-246-003-014

1.8 T (110 kW | 1.8 Liter)

02.98 →	AEB / ANB / APU / ARK / AWT		246-083-002-022G	SWP-D-C	T1: 3
02.98 → 06.99	AEB / ANB / APU / ARK / AWT		246-086-001-002C	HLWP	T1: 3
12.97 →	AEB / ANB / APU / ARK / AWT		246-086-001-007C	HLWP	T1: 3b; T3: X11-246-003-014

1.8 T quattro (110 kW | 1.8 Liter)

02.98 →	AEB / ANB / APU / ARK / AWT		246-083-002-022G	SWP-D-C	T1: 3
02.98 → 04.99	AEB / ANB / APU / ARK / AWT		246-086-001-002C	HLWP	T1: 3
12.97 →	AEB / ANB / APU / ARK / AWT		246-086-001-007C	HLWP	T1: 3b; T3: X11-246-003-014

1.8 T (132 kW | 1.8 Liter)

06.01 →	AJL		246-083-002-022G	SWP-D-C	T1: 3
04.99 →	AJL		246-086-001-007C	HLWP	T1: 3b; T3: X11-246-003-014

1.8 T quattro (132 kW | 1.8 Liter)

02.98 →	AJL		246-083-002-022G	SWP-D-C	T1: 3
02.98 → 07.98	AJL		246-086-001-002C	HLWP	T1: 3
12.97 →	AJL		246-086-001-007C	HLWP	T1: 3b; T3: X11-246-003-014

2.0 (96 kW | 2.0 Liter)

08.01 →	ALT		246-083-002-022G	SWP-D-C	T1: 3
08.01 →	ALT		246-086-001-007C	HLWP	T1: 3b; T3: X11-246-003-014

2.4 (100 kW | 2.4 Liter)

07.98 →	ALW / ARN / ASM		246-083-002-022G	SWP-D-C	T1: 3
07.98 → 01.99	ALW / ARN / ASM		246-086-001-002C	HLWP	T1: 3
07.98 →	ALW / ARN / ASM		246-086-001-007C	HLWP	T1: 3b; T3: X11-246-003-014

2.4 (115 kW | 2.4 Liter)

12.97 →	APC		246-083-002-022G	SWP-D-C	T1: 3
12.97 →	APC		246-086-001-007C	HLWP	T1: 3b; T3: X11-246-003-014

2.4 quattro (115 kW | 2.4 Liter)

08.98 → 05.01	APC		246-082-008-014C	SWP-M-C	T1: 1
08.98 → 05.01	APC		246-083-002-022G	SWP-D-C	T1: 3



			VDO		
Datum	Motorcode	Fahrgestell Nr.	Artikel Nr.	Artikelbez.	Information

AUDI**A6 Avant (4B, C5)****2.4 (120 kW | 2.4 Liter)**

12.97 →	AJG / AMM / APZ		246-083-002-022G	SWP-D-C	T1: 3
12.97 →	AJG / AMM / APZ		246-086-001-007C	HLWP	T1: 3b; T3: X11-246-003-014

2.4 quattro (120 kW | 2.4 Liter)

12.97 →	AJG / APZ		246-083-002-022G	SWP-D-C	T1: 3
12.97 →	AJG / APZ		246-086-001-007C	HLWP	T1: 3b; T3: X11-246-003-014

2.4 (121 kW | 2.4 Liter)

02.98 →	AGA / ALF / AML / APS / ARJ		246-083-002-022G	SWP-D-C	T1: 3
02.98 → 07.99	AGA / ALF / AML / APS / ARJ		246-086-001-002C	HLWP	T1: 3
12.97 →	AGA / ALF / AML / APS / ARJ		246-086-001-007C	HLWP	T1: 3b; T3: X11-246-003-014

2.4 quattro (121 kW | 2.4 Liter)

02.98 →	AGA / ALF / AML / APS / ARJ		246-083-002-022G	SWP-D-C	T1: 3
02.98 → 06.99	AGA / ALF / AML / APS / ARJ		246-086-001-002C	HLWP	T1: 3
12.97 →	AGA / ALF / AML / APS / ARJ		246-086-001-007C	HLWP	T1: 3b; T3: X11-246-003-014

2.4 (125 kW | 2.4 Liter)

08.01 →	BDV		246-083-002-022G	SWP-D-C	T1: 3
08.01 →	BDV		246-086-001-007C	HLWP	T1: 3b; T3: X11-246-003-014

2.4 quattro (125 kW | 2.4 Liter)

08.01 →	BDV		246-083-002-022G	SWP-D-C	T1: 3
08.01 →	BDV		246-086-001-007C	HLWP	T1: 3b; T3: X11-246-003-014

2.7 T (169 kW | 2.7 Liter)

02.99 →	AJK		246-083-002-022G	SWP-D-C	T1: 3
02.99 →	AJK		246-086-001-002C	HLWP	T1: 3
02.99 →	AJK		246-086-001-007C	HLWP	T1: 3b; T3: X11-246-003-014

2.7 T quattro (169 kW | 2.7 Liter)

01.99 →	AJK / AZA		246-083-002-022G	SWP-D-C	T1: 3
01.99 →	AJK / AZA		246-086-001-002C	HLWP	T1: 3
12.97 →	AJK / AZA		246-086-001-007C	HLWP	T1: 3b; T3: X11-246-003-014

2.7 T quattro (184 kW | 2.7 Liter)

08.01 →	ARE / BES		246-083-002-022G	SWP-D-C	T1: 3
08.01 →	ARE / BES		246-086-001-007C	HLWP	T1: 3b; T3: X11-246-003-014

2.8 (132 kW | 2.8 Liter)

02.98 → 07.98	AGE		246-083-002-022G	SWP-D-C	T1: 3
02.98 → 07.98	AGE		246-086-001-002C	HLWP	T1: 3
12.97 → 07.98	AGE		246-086-001-007C	HLWP	T1: 3b; T3: X11-246-003-014



			VDO		
Datum	Motorcode	Fahrgestell Nr.	Artikel Nr.	Artikelbez.	Information

AUDI**A6 Avant (4B, C5)****2.8 (140 kW | 2.8 Liter)**

07.99 →	ATX		246-083-002-022G	SWP-D-C	T1: 3
07.99 → 07.99	ATX		246-086-001-002C	HLWP	T1: 3
07.99 →	ATX		246-086-001-007C	HLWP	T1: 3b; T3: X11-246-003-014

2.8 (142 kW | 2.8 Liter)

02.98 →	ACK / ALG / AMX / APR / AQD		246-083-002-022G	SWP-D-C	T1: 3
02.98 → 07.99	ACK / ALG / AMX / APR / AQD		246-086-001-002C	HLWP	T1: 3
12.97 →	ACK / ALG / AMX / APR / AQD		246-086-001-007C	HLWP	T1: 3b; T3: X11-246-003-014

2.8 quattro (142 kW | 2.8 Liter)

02.98 →	ACK / ALG / AMX / APR / AQD		246-083-002-022G	SWP-D-C	T1: 3
02.98 → 07.98	ACK / ALG / AMX / APR / AQD		246-086-001-002C	HLWP	T1: 3
12.97 →	ACK / ALG / AMX / APR / AQD		246-086-001-007C	HLWP	T1: 3b; T3: X11-246-003-014

3.0 (162 kW | 3.0 Liter)

08.01 →	ASN		246-083-002-022G	SWP-D-C	T1: 3
08.01 →	ASN		246-086-001-007C	HLWP	T1: 3b; T3: X11-246-003-014

3.0 quattro (162 kW | 3.0 Liter)

08.01 →	ASN		246-083-002-022G	SWP-D-C	T1: 3
08.01 →	ASN		246-086-001-007C	HLWP	T1: 3b; T3: X11-246-003-014

3.7 (191 kW | 3.7 Liter)

03.99 →			246-083-002-022G	SWP-D-C	T1: 3
03.99 →			246-086-001-007C	HLWP	T1: 3b; T3: X11-246-003-014

3.7 quattro (191 kW | 3.7 Liter)

03.99 →			246-083-002-022G	SWP-D-C	T1: 3
03.99 →			246-086-001-007C	HLWP	T1: 3b; T3: X11-246-003-014

4.2 quattro (220 kW | 4.2 Liter)

04.99 →	ARS / ASG / AWN		246-083-002-022G	SWP-D-C	T1: 3
04.99 →	ARS / ASG / AWN		246-086-001-002C	HLWP	T1: 3
11.98 →	ARS / ASG / AWN		246-086-001-007C	HLWP	T1: 3b; T3: X11-246-003-014

S6 quattro (250 kW | 4.2 Liter)

09.99 →	ANK / AQJ		246-082-008-014C	SWP-M-C	T1: 1
09.99 →	ANK / AQJ		246-083-002-022G	SWP-D-C	T1: 3
09.99 →	ANK / AQJ		246-086-001-002C	HLWP	T1: 3
09.99 →	ANK / AQJ		246-086-001-007C	HLWP	T1: 3b; T3: X11-246-003-014



			VDO		
Datum	Motorcode	Fahrgestell Nr.	Artikel Nr.	Artikelbez.	Information

AUDI**A6 Avant (4B, C5)****RS6 (331 kW | 4.2 Liter)**

07.02 →	BCY		246-083-002-022G	SWP-D-C	T1: 3
07.02 →	BCY		246-086-001-007C	HLWP	T1: 3b; T3: X11-246-003-014

RS6 plus (353 kW | 4.2 Liter)

04.04 →			246-082-008-014C	SWP-M-C	T1: 1
04.04 →			246-083-002-022G	SWP-D-C	T1: 3

1.9 TDI (81 kW | 1.9 Liter)

01.98 →	AFN / AVG		246-083-002-022G	SWP-D-C	T1: 3
01.98 → 07.98	AFN / AVG		246-086-001-002C	HLWP	T1: 3
12.97 →	AFN / AVG		246-086-001-007C	HLWP	T1: 3b; T3: X11-246-003-014

1.9 TDI (85 kW | 1.9 Liter)

07.00 →	AJM		246-083-002-022G	SWP-D-C	T1: 3
07.00 →	AJM		246-086-001-002C	HLWP	T1: 3
07.00 →	AJM		246-086-001-007C	HLWP	T1: 3b; T3: X11-246-003-014

1.9 TDI (96 kW | 1.9 Liter)

08.01 →	AVF		246-083-002-022G	SWP-D-C	T1: 3
08.01 →	AWX		246-083-002-022G	SWP-D-C	T1: 3
08.01 →	AVF / AWX		246-086-001-007C	HLWP	T1: 3b; T3: X11-246-003-014

2.5 TDI (110 kW | 2.5 Liter)

02.98 →	AFB / AKN		246-083-002-022G	SWP-D-C	T1: 3
02.98 → 04.99	AFB / AKN		246-086-001-002C	HLWP	T1: 3
12.97 →	AFB / AKN		246-086-001-007C	HLWP	T1: 3b; T3: X11-246-003-014

2.5 TDI quattro (110 kW | 2.5 Liter)

02.98 →	AFB / AKN		246-083-002-022G	SWP-D-C	T1: 3
02.98 → 07.98	AFB / AKN		246-086-001-002C	HLWP	T1: 3
12.97 →	AFB / AKN		246-086-001-007C	HLWP	T1: 3b; T3: X11-246-003-014

2.5 TDI (114 kW | 2.5 Liter)

08.01 →	AYM		246-083-002-022G	SWP-D-C	T1: 3
08.01 →	AYM		246-086-001-007C	HLWP	T1: 3b; T3: X11-246-003-014

2.5 TDI (120 kW | 2.5 Liter)

07.02 →	BCZ / BDG / BFC		246-083-002-022G	SWP-D-C	T1: 3
---------	-----------------	--	------------------	---------	-------

2.5 TDI (132 kW | 2.5 Liter)

06.01 →	AKE / BAU / BDH		246-083-002-022G	SWP-D-C	T1: 3
02.00 →	AKE / BAU / BDH		246-086-001-007C	HLWP	T1: 3b; T3: X11-246-003-014



			VDO		
Datum	Motorcode	Fahrgestell Nr.	Artikel Nr.	Artikelbez.	Information

AUDI**A6 Avant (4B, C5)****2.5 TDI quattro (132 kW | 2.5 Liter)**

06.01 →	AKE / BAU / BDH		246-083-002-022G	SWP-D-C	T1: 3
02.00 →	AKE / BAU / BDH		246-086-001-007C	HLWP	T1: 3b; T3: X11-246-003-014

ALLROAD (4BH)**2.7 T quattro (184 kW | 2.7 Liter)**

05.00 →	ARE / BES		246-083-002-022G	SWP-D-C	T1: 3
05.00 →	ARE / BES		246-086-001-007C	HLWP	T1: 3b; T3: X11-246-003-014

4.2 V8 (220 kW | 4.2 Liter)

07.02 →	BAS		246-083-002-022G	SWP-D-C	T1: 3
07.02 →	BAS		246-086-001-007C	HLWP	T1: 3b; T3: X11-246-003-014

2.5 TDI quattro (120 kW | 2.5 Liter)

05.03 →	BCZ		246-083-002-022G	SWP-D-C	T1: 3
---------	-----	--	------------------	---------	-------

2.5 TDI quattro (132 kW | 2.5 Liter)

05.00 →	AKE / BAU		246-083-002-022G	SWP-D-C	T1: 3
05.00 →	AKE / BAU		246-086-001-007C	HLWP	T1: 3b; T3: X11-246-003-014

A6 (4F2)**2.0 TFSI (125 kW | 2.0 Liter)**

06.05 →	BPJ	4F-5-000 001 →	246-082-008-025G	SWP-M-C	T1: 3
06.05 →	BPJ	4F-5-000 001 →	246-083-002-022G	SWP-D-C	T1: 3

2.4 (130 kW | 2.4 Liter)

05.04 →	BDW	4F-5-000 001 →	246-082-008-025G	SWP-M-C	T1: 3
05.04 →	BDW	4F-5-000 001 →	246-083-002-022G	SWP-D-C	T1: 3

2.4 quattro (130 kW | 2.4 Liter)

01.05 →	BDW	4F-5-000 001 →	246-082-008-025G	SWP-M-C	T1: 3
01.05 →	BDW	4F-5-000 001 →	246-083-002-022G	SWP-D-C	T1: 3

3.2 FSI (188 kW | 3.2 Liter)

05.04 →	AUK	4F-5-000 001 →	246-082-008-025G	SWP-M-C	T1: 3
05.04 →	AUK	4F-5-000 001 →	246-083-002-022G	SWP-D-C	T1: 3

3.2 FSI quattro (188 kW | 3.2 Liter)

05.04 →	AUK	4F-5-000 001 →	246-082-008-025G	SWP-M-C	T1: 3
05.04 →	AUK	4F-5-000 001 →	246-083-002-022G	SWP-D-C	T1: 3

4.2 quattro (246 kW | 4.2 Liter)

05.04 →	BAT	4F-5-000 001 →	246-082-008-025G	SWP-M-C	T1: 3
05.04 →	BAT	4F-5-000 001 →	246-083-002-022G	SWP-D-C	T1: 3

2.0 TDI (103 kW | 2.0 Liter)

07.04 →	BLB / BRE	4F-5-000 001 →	246-082-008-025G	SWP-M-C	T1: 3
07.04 →	BLB / BRE	4F-5-000 001 →	246-083-002-022G	SWP-D-C	T1: 3



			VDO		
Datum	Motorcode	Fahrgestell Nr.	Artikel Nr.	Artikelbez.	Information





AUDI**A6 (4F2)**

2.7 TDI (120 kW 2.7 Liter)					
11.04 →	BSG	4F-5-000 001 →	246-082-008-025G	SWP-M-C	T1: 3
11.04 →	BSG	4F-5-000 001 →	246-083-002-022G	SWP-D-C	T1: 3
2.7 TDI (132 kW 2.7 Liter)					
11.04 →		4F-5-000 001 →	246-082-008-025G	SWP-M-C	T1: 3
11.04 →		4F-5-000 001 →	246-083-002-022G	SWP-D-C	T1: 3
2.7 TDI quattro (132 kW 2.7 Liter)					
11.04 →		4F-5-000 001 →	246-082-008-025G	SWP-M-C	T1: 3
11.04 →		4F-5-000 001 →	246-083-002-022G	SWP-D-C	T1: 3
3.0 TDI quattro (155 kW 3.0 Liter)					
05.04 →	BNG	4F-5-000 001 →	246-082-008-025G	SWP-M-C	T1: 3
05.04 →	BNG	4F-5-000 001 →	246-083-002-022G	SWP-D-C	T1: 3
3.0 TDI quattro (165 kW 3.0 Liter)					
05.04 →	BMK	4F-5-000 001 →	246-082-008-025G	SWP-M-C	T1: 3
05.04 →	BMK	4F-5-000 001 →	246-083-002-022G	SWP-D-C	T1: 3

A6 Avant (4F5)

2.0 TFSI (125 kW 2.0 Liter)					
06.05 →	BPJ	4F-5-000 001 →	246-083-002-022G	SWP-D-C	T1: 3
2.4 (130 kW 2.4 Liter)					
03.05 →	BDW	4F-5-000 001 →	246-083-002-022G	SWP-D-C	T1: 3
2.4 quattro (130 kW 2.4 Liter)					
03.05 →	BDW	4F-5-000 001 →	246-083-002-022G	SWP-D-C	T1: 3
3.2 FSI (188 kW 3.2 Liter)					
03.05 →	AUK	4F-5-000 001 →	246-083-002-022G	SWP-D-C	T1: 3
3.2 FSI quattro (188 kW 3.2 Liter)					
03.05 →	AUK	4F-5-000 001 →	246-083-002-022G	SWP-D-C	T1: 3
4.2 quattro (246 kW 4.2 Liter)					
03.05 →	BAT	4F-5-000 001 →	246-083-002-022G	SWP-D-C	T1: 3
2.0 TDI (103 kW 2.0 Liter)					
06.05 →	BLB / BRE	4F-5-000 001 →	246-083-002-022G	SWP-D-C	T1: 3
2.7 TDI (120 kW 2.7 Liter)					
03.05 →	BSG	4F-5-000 001 →	246-083-002-022G	SWP-D-C	T1: 3
2.7 TDI (132 kW 2.7 Liter)					
03.05 →		4F-5-000 001 →	246-083-002-022G	SWP-D-C	T1: 3
2.7 TDI quattro (132 kW 2.7 Liter)					
03.05 →		4F-5-000 001 →	246-083-002-022G	SWP-D-C	T1: 3
3.0 TDI quattro (155 kW 3.0 Liter)					
03.05 →	BNG	4F-5-000 001 →	246-083-002-022G	SWP-D-C	T1: 3
3.0 TDI quattro (165 kW 3.0 Liter)					
03.05 →	BMK	4F-5-000 001 →	246-083-002-022G	SWP-D-C	T1: 3



			VDO		
Datum	Motorcode	Fahrgestell Nr.	Artikel Nr.	Artikelbez.	Information

AUDI**V8 (44_, 4C_)****3.6 quattro (180 kW | 3.6 Liter)**

04.93 → 07.93 PT 246-082-008-014C SWP-M-C T1: 1

3.6 quattro (184 kW | 3.6 Liter)

10.88 → 07.90 PT 246-082-008-014C SWP-M-C T1: 1

4.2 quattro (206 kW | 4.2 Liter)

10.91 → 07.93 ABH 246-082-008-014C SWP-M-C T1: 1

A8 (4D2, 4D8)**2.8 (120 kW | 2.8 Liter)**

07.95 → 03.96 AEJ 246-086-001-002C HLWP T1: 3

07.95 → 03.96 AEJ 246-086-001-007C HLWP T1: 3b; T3:
X11-246-003-014**2.8 quattro (120 kW | 2.8 Liter)**07.95 → 03.96 AEJ 246-086-001-007C HLWP T1: 3b; T3:
X11-246-003-014**2.8 (128 kW | 2.8 Liter)**

06.94 → 03.96 AAH 246-086-001-002C HLWP T1: 3

03.94 → 03.96 AAH 246-086-001-007C HLWP T1: 3b; T3:
X11-246-003-014**2.8 quattro (128 kW | 2.8 Liter)**03.94 → 03.96 AAH 246-086-001-007C HLWP T1: 3b; T3:
X11-246-003-014**2.8 (142 kW | 2.8 Liter)**

04.96 → 05.99 ACK / ALG / AMX / APR / AQD 246-086-001-002C HLWP T1: 3

04.96 → 09.02 ACK / ALG / AMX / APR / AQD 246-086-001-007C HLWP T1: 3b; T3:
X11-246-003-014**2.8 quattro (142 kW | 2.8 Liter)**04.96 → 09.02 ACK / AMX / APR / AQD 246-086-001-007C HLWP T1: 3b; T3:
X11-246-003-014**3.7 (169 kW | 3.7 Liter)**





06.97 → 12.98 AEW 246-086-001-002C HLWP T1: 3

07.95 → 12.98 AEW 246-086-001-007C HLWP T1: 3b; T3:
X11-246-003-014**3.7 quattro (169 kW | 3.7 Liter)**07.95 → 11.98 AEW / AKJ 246-086-001-007C HLWP T1: 3b; T3:
X11-246-003-014**3.7 (191 kW | 3.7 Liter)**

11.98 → 12.98 AKC / AQQ 246-086-001-002C HLWP T1: 3

11.98 → 09.02 AKC / AQQ 246-086-001-007C HLWP T1: 3b; T3:
X11-246-003-014**3.7 quattro (191 kW | 3.7 Liter)**11.98 → 09.02 AKC / AQQ 246-086-001-007C HLWP T1: 3b; T3:
X11-246-003-014



			VDO		
Datum	Motorcode	Fahrgestell Nr.	Artikel Nr.	Artikelbez.	Information

AUDI**A8 (4D2, 4D8)**

4.2 quattro (175 kW 4.2 Liter)					
02.99 → 04.00	ARU		246-086-001-007C	HLWP	T1: 3b; T3: X11-246-003-014
4.2 quattro (180 kW 4.2 Liter)					
03.94 → 07.96	AEM		246-086-001-007C	HLWP	T1: 3b; T3: X11-246-003-014
4.2 quattro (220 kW 4.2 Liter)					
03.94 → 11.98	ABZ / AKG		246-086-001-007C	HLWP	T1: 3b; T3: X11-246-003-014
4.2 quattro (228 kW 4.2 Liter)					
11.98 → 09.02	AQF / AUW / AUX		246-086-001-007C	HLWP	T1: 3b; T3: X11-246-003-014
S 8 quattro (250 kW 4.2 Liter)					
09.96 → 04.99	AHC / AKH		246-086-001-002C	HLWP	T1: 3
07.96 → 06.99	AHC / AKH		246-086-001-007C	HLWP	T1: 3b; T3: X11-246-003-014
S 8 quattro (265 kW 4.2 Liter)					
06.99 → 09.02	AQH / AVP		246-086-001-002C	HLWP	T1: 3
06.99 → 09.02	AQH / AVP		246-086-001-007C	HLWP	T1: 3b; T3: X11-246-003-014
6.0 W12 quattro (309 kW 6.0 Liter)					
04.01 → 09.02	AZC		246-086-001-002C	HLWP	T1: 3
01.01 → 09.02	AZC		246-086-001-007C	HLWP	T1: 3b; T3: X11-246-003-014
2.5 TDI (110 kW 2.5 Liter)					
06.97 → 11.99	AFB / AKN		246-086-001-002C	HLWP	T1: 3
01.97 → 04.00	AFB / AKN		246-086-001-007C	HLWP	T1: 3b; T3: X11-246-003-014
2.5 TDI quattro (110 kW 2.5 Liter)					
07.97 → 04.00	AFB / AKN		246-086-001-007C	HLWP	T1: 3b; T3: X11-246-003-014
2.5 TDI (132 kW 2.5 Liter)					
09.00 → 09.02	AKE		246-086-001-007C	HLWP	T1: 3b; T3: X11-246-003-014
2.5 TDI quattro (132 kW 2.5 Liter)					
09.00 → 09.02	AKE		246-086-001-007C	HLWP	T1: 3b; T3: X11-246-003-014
3.3 TDI quattro (165 kW 3.3 Liter)					
06.00 → 09.02	AKF		246-086-001-007C	HLWP	T1: 3b; T3: X11-246-003-014

A8 (4E_)

3.0 (160 kW 3.0 Liter)					
07.03 →	BBJ		246-082-008-025G	SWP-M-C	T1: 3



			VDO		
Datum	Motorcode	Fahrgestell Nr.	Artikel Nr.	Artikelbez.	Information

AUDI**A8 (4E_)****3.0 (162 kW | 3.0 Liter)**

08.03 → ASN 246-082-008-025G SWP-M-C T1: 3

3.2 FSI (191 kW | 3.2 Liter)

06.05 → BPK 246-082-008-025G SWP-M-C T1: 3

3.2 FSI quattro (191 kW | 3.2 Liter)

06.05 → BPK 4E-3-000-001 → 246-082-008-025G SWP-M-C T1: 3

3.7 quattro (206 kW | 3.7 Liter)

10.02 → BFL 4E-3-000-001 → 246-082-008-025G SWP-M-C T1: 3

4.2 quattro (246 kW | 4.2 Liter)

10.02 → BFM 4E-3-000-001 → 246-082-008-025G SWP-M-C T1: 3

6.0 W12 quattro (331 kW | 6.0 Liter)

12.03 → BHT / BTE 4E-3-000-001 → 246-082-008-025G SWP-M-C T1: 3

3.0 TDI quattro (155 kW | 3.0 Liter)

11.03 → BNG 4E-3-000-001 → 246-082-008-025G SWP-M-C T1: 3

3.0 TDI quattro (171 kW | 3.0 Liter)

08.03 → ASB 4F-5-000 001 → 246-082-008-025G SWP-M-C T1: 3

4.0 TDI quattro (202 kW | 4.0 Liter)

03.03 → ASE 4E-3-000-001 → 246-082-008-025G SWP-M-C T1: 3

4.2 TDI quattro (235 kW | 4.2 Liter)

07.05 → BMC 4E-3-000-001 → 246-082-008-025G SWP-M-C T1: 3

TT (8N3)**1.8 T (110 kW | 1.8 Liter)**

09.02 → AUM 246-082-008-025G SWP-M-C T1: 3

1.8 T (120 kW | 1.8 Liter)

09.05 → BVP 246-082-008-025G SWP-M-C T1: 3

1.8 T (132 kW | 1.8 Liter)

10.98 → AJQ / APP / ARY / ATC / AUQ / AWP 246-082-008-025G SWP-M-C T1: 3

10.98 → AJQ / APP / ARY / ATC / AUQ / AWP 246-086-001-002C HLWP T1: 3

10.98 → AJQ / APP / ARY / ATC / AUQ / AWP 246-086-001-007C HLWP T1: 3b; T3: X11-246-003-014

1.8 T quattro (132 kW | 1.8 Liter)

10.98 → AJQ / ARY / ATC / AWP 246-082-008-025G SWP-M-C T1: 3

10.98 → AJQ / ARY / ATC / AWP 246-086-001-002C HLWP T1: 3

10.98 → AJQ / ARY / ATC / AWP 246-086-001-007C HLWP T1: 3b; T3: X11-246-003-014

1.8 T (140 kW | 1.8 Liter)

09.05 → BVR 246-082-008-025G SWP-M-C T1: 3

1.8 T quattro (140 kW | 1.8 Liter)

09.05 → BVR 246-082-008-025G SWP-M-C T1: 3



			VDO		
Datum	Motorcode	Fahrgestell Nr.	Artikel Nr.	Artikelbez.	Information

AUDI**TT (8N3)****1.8 T quattro (165 kW | 1.8 Liter)**

10.98 →	AMU / APX / BAM		246-082-008-025G	SWP-M-C	T1: 3
10.98 →	AMU / APX / BAM		246-086-001-002C	HLWP	T1: 3
10.98 →	AMU / APX / BAM		246-086-001-007C	HLWP	T1: 3b; T3: X11-246-003-014

1.8 T quattro (176 kW | 1.8 Liter)

03.05 →			246-082-008-025G	SWP-M-C	T1: 3
---------	--	--	------------------	---------	-------

3.2 VR6 quattro (184 kW | 3.2 Liter)

07.03 →	BHE		246-082-008-025G	SWP-M-C	T1: 3
---------	-----	--	------------------	---------	-------

TT Roadster (8N9)**1.8 T (110 kW | 1.8 Liter)**

01.01 →	AUM		246-086-001-007C	HLWP	T1: 3b; T3: X11-246-003-014
---------	-----	--	------------------	------	--------------------------------

1.8 T (132 kW | 1.8 Liter)

10.99 →	AJQ / APP / ATC / AUQ / AWP		246-082-008-025G	SWP-M-C	T1: 3
10.99 →	AJQ / APP / ATC / AUQ / AWP		246-086-001-002C	HLWP	T1: 3
10.99 →	AJQ / APP / ATC / AUQ / AWP		246-086-001-007C	HLWP	T1: 3b; T3: X11-246-003-014

1.8 T quattro (132 kW | 1.8 Liter)

02.00 →	AJQ / ARY / ATC / AWP		246-082-008-025G	SWP-M-C	T1: 3
02.00 →	AJQ / ARY / ATC / AWP		246-086-001-002C	HLWP	T1: 3
02.00 →	AJQ / ARY / ATC / AWP		246-086-001-007C	HLWP	T1: 3b; T3: X11-246-003-014

1.8 T quattro (165 kW | 1.8 Liter)

10.99 →	AMU / APX / BAM		246-082-008-025G	SWP-M-C	T1: 3
10.99 →	AMU / APX / BAM		246-086-001-002C	HLWP	T1: 3
10.99 →	AMU / APX / BAM		246-086-001-007C	HLWP	T1: 3b; T3: X11-246-003-014

50 (86)**1.1 (37 kW | 1.1 Liter)**

08.74 → 07.78	HB		246-075-021-006C	SWP-M-G	T1: 1; T2: B
---------------	----	--	------------------	---------	--------------

1.1 (44 kW | 1.1 Liter)

08.74 → 07.77	HC		246-075-021-006C	SWP-M-G	T1: 1; T2: B
---------------	----	--	------------------	---------	--------------





1.3 (44 kW | 1.3 Liter)

08.77 → 07.78	HH		246-075-021-006C	SWP-M-G	T1: 1; T2: B
---------------	----	--	------------------	---------	--------------

80 (80, 82, B1)**1.3 (40 kW | 1.3 Liter)**

05.72 → 12.76	ZA	→ 827 2084 529	246-075-021-006C	SWP-M-G	T1: 1; T2: B
12.76 → 07.78	ZA	827 2084 530 →	246-082-008-014C	SWP-M-C	T1: 1



			VDO		
Datum	Motorcode	Fahrgestell Nr.	Artikel Nr.	Artikelbez.	Information

AUDI**80 (80, 82, B1)****1.3 (44 kW | 1.3 Liter)**

03.73 → 12.76	ZF	→ 827 2084 529	246-075-021-006C	SWP-M-G	T1: 1; T2: B
12.76 → 07.78	ZF	827 2084 530 →	246-082-008-014C	SWP-M-C	T1: 1

1.5 (55 kW | 1.5 Liter)

03.73 → 08.75	YJ / ZB		246-075-021-006C	SWP-M-G	T1: 1; T2: B
---------------	---------	--	------------------	---------	--------------

1.5 (63 kW | 1.5 Liter)

05.73 → 08.75	ZC		246-075-021-006C	SWP-M-G	T1: 1; T2: B
---------------	----	--	------------------	---------	--------------

1.6 (55 kW | 1.6 Liter)

09.75 → 12.76	YN	→ 827 2084 529	246-075-021-006C	SWP-M-G	T1: 1; T2: B
12.76 → 07.78	YN	827 2084 530 →	246-082-008-014C	SWP-M-C	T1: 1

1.6 GT (74 kW | 1.6 Liter)

09.73 → 08.75	XX		246-075-021-006C	SWP-M-G	T1: 1; T2: B
---------------	----	--	------------------	---------	--------------

1.6 GTE (81 kW | 1.6 Liter)

01.76 → 12.76	YS	→ 827 2084 529	246-075-021-006C	SWP-M-G	T1: 1; T2: B
12.76 → 07.78	YS	827 2084 530 →	246-082-008-014C	SWP-M-C	T1: 1

80 (81, 85, B2)**1.3 (40 kW | 1.3 Liter)**

09.78 → 07.81	FY		246-082-008-014C	SWP-M-C	T1: 1
09.78 → 07.81	FY		246-086-001-007C	HLWP	T1: 3b; T3: X11-246-003-014

1.3 (44 kW | 1.3 Liter)

09.78 → 07.81	FZ		246-082-008-014C	SWP-M-C	T1: 1
---------------	----	--	------------------	---------	-------

1.3 (44 kW | 1.3 Liter)

08.81 → 07.86	EP		246-082-008-014C	SWP-M-C	T1: 1
09.78 → 07.86	EP		246-086-001-007C	HLWP	T1: 3b; T3: X11-246-003-014

1.6 (51 kW | 1.6 Liter)

08.78 → 07.81	YT / YY		246-082-008-014C	SWP-M-C	T1: 1
---------------	---------	--	------------------	---------	-------

1.6 (54 kW | 1.6 Liter)

02.86 → 07.86	SA		246-082-008-014C	SWP-M-C	T1: 1
02.86 → 07.86	SA		246-086-001-007C	HLWP	T1: 3b; T3: X11-246-003-014

1.6 (55 kW | 1.6 Liter)

08.78 → 07.86	WV / YN		246-082-008-014C	SWP-M-C	T1: 1
---------------	---------	--	------------------	---------	-------

1.6 (55 kW | 1.6 Liter)

08.81 → 07.86	DT		246-082-008-014C	SWP-M-C	T1: 1
08.78 → 07.86	DT		246-086-001-007C	HLWP	T1: 3b; T3: X11-246-003-014

1.6 (63 kW | 1.6 Liter)

08.78 → 02.83	YP	827 2084 530 →	246-082-008-014C	SWP-M-C	T1: 1
08.78 → 02.83	YP		246-086-001-007C	HLWP	T1: 3b; T3: X11-246-003-014



			VDO		
Datum	Motorcode	Fahrgestell Nr.	Artikel Nr.	Artikelbez.	Information

AUDI**80 (81, 85, B2)****1.6 GLE (81 kW | 1.6 Liter)**

01.79 → 07.82	YZ		246-082-008-014C	SWP-M-C	T1: 1
01.79 → 12.86	YZ		246-086-001-007C	HLWP	T1: 3b; T3: X11-246-003-014

1.8 (65 kW | 1.8 Liter)

02.86 → 07.86	SF		246-082-008-014C	SWP-M-C	T1: 1
02.86 → 07.86	SF		246-086-001-007C	HLWP	T1: 3b; T3: X11-246-003-014

1.8 (66 kW | 1.8 Liter)

01.83 → 08.86	DS		246-082-008-014C	SWP-M-C	T1: 1
01.83 → 08.86	DS		246-086-001-007C	HLWP	T1: 3b; T3: X11-246-003-014

1.8 CC quattro (85Q) (66 kW | 1.8 Liter)

08.84 → 08.86	NE		246-082-008-014C	SWP-M-C	T1: 1
08.84 → 08.86	NE		246-086-001-007C	HLWP	T1: 3b; T3: X11-246-003-014

1.8 (68 kW | 1.8 Liter)

08.83 → 08.86	JN		246-086-001-007C	HLWP	T1: 3b; T3: X11-246-003-014
---------------	----	--	------------------	------	--------------------------------

1.8 CC quattro (85Q) (68 kW | 1.8 Liter)

08.85 → 08.86	JN		246-086-001-007C	HLWP	T1: 3b; T3: X11-246-003-014
---------------	----	--	------------------	------	--------------------------------

1.8 GTE (81 kW | 1.8 Liter)

08.85 → 07.86	PV		246-082-008-014C	SWP-M-C	T1: 1
08.85 → 07.86	PV		246-086-001-007C	HLWP	T1: 3b; T3: X11-246-003-014

1.8 GTE quattro (85Q) (81 kW | 1.8 Liter)

03.85 → 08.86	PV		246-082-008-014C	SWP-M-C	T1: 1
03.85 → 08.86	PV		246-086-001-007C	HLWP	T1: 3b; T3: X11-246-003-014

1.8 GTE (82 kW | 1.8 Liter)

10.84 → 08.86	DZ		246-082-008-014C	SWP-M-C	T1: 1
10.84 → 08.86	DZ		246-086-001-007C	HLWP	T1: 3b; T3: X11-246-003-014

1.8 GTE quattro (85Q) (82 kW | 1.8 Liter)

08.84 → 08.86	DZ		246-082-008-014C	SWP-M-C	T1: 1
08.84 → 08.86	DZ		246-086-001-007C	HLWP	T1: 3b; T3: X11-246-003-014

1.9 CD-5S (85 kW | 1.9 Liter)

09.81 → 07.83	WN		246-082-008-014C	SWP-M-C	T1: 1
09.81 → 07.83	WN		246-086-001-007C	HLWP	T1: 3b; T3: X11-246-003-014



			VDO		
Datum	Motorcode	Fahrgestell Nr.	Artikel Nr.	Artikelbez.	Information

AUDI**80 (81, 85, B2)****2.0 (85 kW | 2.0 Liter)**

10.83 → 09.84	HP / JS		246-082-008-014C	SWP-M-C	T1: 1
10.83 → 09.84	HP / JS		246-086-001-007C	HLWP	T1: 3b; T3: X11-246-003-014

2.0 quattro (85Q) (85 kW | 2.0 Liter)

10.83 → 07.84	JS		246-082-008-014C	SWP-M-C	T1: 1
10.83 → 09.84	JS		246-086-001-007C	HLWP	T1: 3b; T3: X11-246-003-014

2.2 (85 kW | 2.2 Liter)

10.80 → 07.83	WE		246-082-008-014C	SWP-M-C	T1: 1
10.80 → 07.83	WE		246-086-001-007C	HLWP	T1: 3b; T3: X11-246-003-014

2.2 quattro (96 kW | 2.2 Liter)

08.82 → 07.84	KL		246-082-008-014C	SWP-M-C	T1: 1
---------------	----	--	------------------	---------	-------

2.2 quattro (85Q) (100 kW | 2.2 Liter)

08.82 → 07.84	KK		246-082-008-014C	SWP-M-C	T1: 1
08.82 → 07.84	KK		246-086-001-007C	HLWP	T1: 3b; T3: X11-246-003-014

1.6 D (40 kW | 1.6 Liter)

08.81 → 08.86	CR / JK		246-082-008-014C	SWP-M-C	T1: 1
08.80 → 08.86	CR / JK		246-086-001-007C	HLWP	T1: 3b; T3: X11-246-003-014

1.6 TD (51 kW | 1.6 Liter)

02.82 → 05.86	CY		246-082-008-014C	SWP-M-C	T1: 1
08.81 → 05.86	CY		246-086-001-007C	HLWP	T1: 3b; T3: X11-246-003-014

COUPE (81, 85)**1.6 (55 kW | 1.6 Liter)**

02.81 → 08.81	YN		246-082-008-014C	SWP-M-C	T1: 1
07.80 → 08.81	YN		246-086-001-007C	HLWP	T1: 3b; T3: X11-246-003-014; T7: GL →

1.8 (55 kW | 1.8 Liter)

09.82 → 07.83	DD		246-082-008-014C	SWP-M-C	T1: 1
08.81 → 07.83	DD		246-086-001-007C	HLWP	T1: 3b; T3: X11-246-003-014; T7: GL →

1.8 GT (65 kW | 1.8 Liter)

07.86 → 07.88	SF		246-082-008-014C	SWP-M-C	T1: 1
04.86 → 10.88	SF		246-086-001-007C	HLWP	T1: 3b; T3: X11-246-003-014; T7: GL →



			VDO		
Datum	Motorcode	Fahrgestell Nr.	Artikel Nr.	Artikelbez.	Information

AUDI**COUPE (81, 85)****1.8 GT (66 kW | 1.8 Liter)**

08.84 → 07.88	DS / JV		246-082-008-014C	SWP-M-C	T1: 1
09.82 → 10.88	DS / JV		246-086-001-007C	HLWP	T1: 3b; T3: X11-246-003-014; T7: GL →

1.8 GT quattro (66 kW | 1.8 Liter)

09.85 → 10.88	DS / JN / NE		246-082-008-014C	SWP-M-C	T1: 1
---------------	--------------	--	------------------	---------	-------

1.8 GT (68 kW | 1.8 Liter)

01.85 → 07.88	JN		246-086-001-007C	HLWP	T1: 3b; T3: X11-246-003-014; T7: GL →
---------------	----	--	------------------	------	---------------------------------------------

1.8 GT (79 kW | 1.8 Liter)

08.86 → 10.87	PV		246-082-008-014C	SWP-M-C	T1: 1
08.86 → 10.87	PV		246-086-001-007C	HLWP	T1: 3b; T3: X11-246-003-014; T7: GL →

1.8 GT (82 kW | 1.8 Liter)

08.86 → 10.88	DZ		246-086-001-007C	HLWP	T1: 3b; T3: X11-246-003-014; T7: GL →
---------------	----	--	------------------	------	---------------------------------------------

1.8 GT quattro (82 kW | 1.8 Liter)

12.84 → 10.88	DZ		246-082-008-014C	SWP-M-C	T1: 1
---------------	----	--	------------------	---------	-------

1.9 (85 kW | 1.9 Liter)

10.80 → 07.83	WN		246-082-008-014C	SWP-M-C	T1: 1
08.80 → 07.83	WN		246-086-001-007C	HLWP	T1: 3b; T3: X11-246-003-014; T7: GL →

2.0 (85 kW | 2.0 Liter)

09.83 → 07.86	HP / JS		246-082-008-014C	SWP-M-C	T1: 1
09.83 → 07.86	HP / JS		246-086-001-007C	HLWP	T1: 3b; T3: X11-246-003-014; T7: GL →

2.0 (83 kW | 2.0 Liter)

03.86 → 07.87	SK		246-082-008-014C	SWP-M-C	T1: 1
03.86 → 04.88	SK		246-086-001-007C	HLWP	T1: 3b; T3: X11-246-003-014; T7: GL →

2.1 GT (79 kW | 2.1 Liter)

01.81 → 07.83	WE		246-086-001-007C	HLWP	T1: 3b; T3: X11-246-003-014; T7: GL →
---------------	----	--	------------------	------	---------------------------------------------



			VDO		
Datum	Motorcode	Fahrgestell Nr.	Artikel Nr.	Artikelbez.	Information

AUDI**COUPE (81, 85)****2.1 GT (96 kW | 2.1 Liter)**

09.82 → 08.84	KE / KL		246-082-008-014C	SWP-M-C	T1: 1
09.82 → 08.84	KE / KL		246-086-001-007C	HLWP	T1: 3b; T3: X11-246-003-014; T7: GL →

2.2 quattro (88 kW | 2.2 Liter)

08.85 → 12.87	JT		246-082-008-014C	SWP-M-C	T1: 1
08.85 → 10.88	JT		246-086-001-007C	HLWP	T1: 3b; T3: X11-246-003-014; T7: GL →

2.2 GT (100 kW | 2.2 Liter)

09.84 → 10.88	KV		246-082-008-014C	SWP-M-C	T1: 1
09.84 → 10.88	KV		246-086-001-007C	HLWP	T1: 3b; T3: X11-246-003-014; T7: GL →

2.2 quattro (100 kW | 2.2 Liter)

12.84 → 12.87	KV		246-082-008-014C	SWP-M-C	T1: 1
10.84 → 10.88	KV		246-086-001-007C	HLWP	T1: 3b; T3: X11-246-003-014; T7: GL →

2.2 GT (85 kW | 2.2 Liter)

01.85 → 10.87	KX		246-082-008-014C	SWP-M-C	T1: 1
07.81 → 10.87	KX		246-086-001-007C	HLWP	T1: 3b; T3: X11-246-003-014; T7: GL →

2.3 (100 kW | 2.3 Liter)

02.87 → 07.88	NG		246-082-008-014C	SWP-M-C	T1: 1
01.87 → 10.88	NG		246-086-001-007C	HLWP	T1: 3b; T3: X11-246-003-014; T7: GL →

2.3 quattro (100 kW | 2.3 Liter)

01.87 → 12.87	NG		246-082-008-014C	SWP-M-C	T1: 1
01.87 → 10.88	NG		246-086-001-007C	HLWP	T1: 3b; T3: X11-246-003-014; T7: GL →

QUATTRO (85)**2.1 Turbo (147 kW | 2.1 Liter)**

07.80 → 07.87	GV / WR		246-082-008-014C	SWP-M-C	T1: 1
07.80 → 07.87	GV / WR		246-086-001-007C	HLWP	T1: 3b; T3: X11-246-003-014



			VDO		
Datum	Motorcode	Fahrgestell Nr.	Artikel Nr.	Artikelbez.	Information





AUDI**QUATTRO (85)**

2.1 20V Turbo (225 kW 2.1 Liter)					
05.84 → 07.87	KW		246-082-008-014C	SWP-M-C	T1: 1
05.84 → 07.87	KW		246-086-001-007C	HLWP	T1: 3b; T3: X11-246-003-014
2.2 Turbo (147 kW 2.2 Liter)					
08.87 → 07.89	1B / MB		246-082-008-014C	SWP-M-C	T1: 1
08.87 → 07.89	1B / MB		246-086-001-007C	HLWP	T1: 3b; T3: X11-246-003-014
2.2 20V (162 kW 2.2 Liter)					
08.89 → 07.91	RR		246-082-008-014C	SWP-M-C	T1: 1
08.89 → 07.91	RR		246-086-001-007C	HLWP	T1: 3b; T3: X11-246-003-014

80 (89, 89Q, 8A, B3)

1.6 (51 kW 1.6 Liter)					
08.87 → 08.91	PP		246-082-008-014C	SWP-M-C	T1: 1
08.89 → 08.91	PP		246-086-001-002C	HLWP	T1: 3
08.87 → 09.91	PP		246-086-001-007C	HLWP	T1: 3b; T3: X11-246-003-014
1.6 (55 kW 1.6 Liter)					
09.86 → 08.91	RN		246-082-008-014C	SWP-M-C	T1: 1
08.89 → 08.91	RN		246-086-001-002C	HLWP	T1: 3
09.86 → 08.91	RN		246-086-001-007C	HLWP	T1: 3b; T3: X11-246-003-014
1.6 (75 kW 1.6 Liter)					
08.90 → 10.91	ABB		246-082-008-014C	SWP-M-C	T1: 1
1.8 (55 kW 1.8 Liter)					
10.86 → 01.90	RU		246-082-008-014C	SWP-M-C	T1: 1
08.89 → 01.90	RU		246-086-001-002C	HLWP	T1: 3
10.86 → 01.90	RU		246-086-001-007C	HLWP	T1: 3b; T3: X11-246-003-014
1.4 (48 kW 1.4 Liter)					
08.86 → 07.88	SE		246-082-008-014C	SWP-M-C	T1: 1
1.8 S (65 kW 1.8 Liter)					
09.86 → 12.90	SF		246-082-008-014C	SWP-M-C	T1: 1
08.89 → 12.90	SF		246-086-001-002C	HLWP	T1: 3
09.86 → 12.90	SF		246-086-001-007C	HLWP	T1: 3b; T3: X11-246-003-014
1.8 S quattro (65 kW 1.8 Liter)					
09.86 → 07.90	SF		246-082-008-014C	SWP-M-C	T1: 1



			VDO		
Datum	Motorcode	Fahrgestell Nr.	Artikel Nr.	Artikelbez.	Information

AUDI**80 (89, 89Q, 8A, B3)****1.8 S (66 kW | 1.8 Liter)**

09.86 → 08.91	JN / NE / PM		246-082-008-014C	SWP-M-C	T1: 1
08.89 → 08.91	JN / NE / PM		246-086-001-002C	HLWP	T1: 3
09.86 → 10.91	JN / NE / PM		246-086-001-007C	HLWP	T1: 3b; T3: X11-246-003-014

1.8 S quattro (66 kW | 1.8 Liter)

09.86 → 07.90	JN / NE / PM		246-082-008-014C	SWP-M-C	T1: 1
---------------	--------------	--	------------------	---------	-------

1.8 E (82 kW | 1.8 Liter)

09.86 → 08.91	DZ		246-082-008-014C	SWP-M-C	T1: 1
08.89 → 08.91	DZ		246-086-001-002C	HLWP	T1: 3
06.86 → 08.91	DZ		246-086-001-007C	HLWP	T1: 3b; T3: X11-246-003-014

1.8 E quattro (82 kW | 1.8 Liter)

09.86 → 08.91	DZ		246-082-008-014C	SWP-M-C	T1: 1
---------------	----	--	------------------	---------	-------

1.8 (83 kW | 1.8 Liter)

09.86 → 07.88	SD		246-082-008-014C	SWP-M-C	T1: 1
09.86 → 07.88	SD		246-086-001-007C	HLWP	T1: 3b; T3: X11-246-003-014

1.8 quattro (83 kW | 1.8 Liter)

09.86 → 07.88	SD		246-082-008-014C	SWP-M-C	T1: 1
---------------	----	--	------------------	---------	-------

2.0 (82 kW | 2.0 Liter)

10.90 → 08.91	AAD		246-086-001-007C	HLWP	T1: 3b; T3: X11-246-003-014
---------------	-----	--	------------------	------	--------------------------------

2.0 quattro (82 kW | 2.0 Liter)

10.90 → 08.91	3A		246-082-008-014C	SWP-M-C	T1: 1
---------------	----	--	------------------	---------	-------

2.0 E (83 kW | 2.0 Liter)

08.88 → 10.90	3A		246-082-008-014C	SWP-M-C	T1: 1
08.89 → 10.90	3A		246-086-001-002C	HLWP	T1: 3
08.88 → 10.90	3A		246-086-001-007C	HLWP	T1: 3b; T3: X11-246-003-014

2.0 E quattro (83 kW | 2.0 Liter)

08.88 → 09.90	3A		246-082-008-014C	SWP-M-C	T1: 1
---------------	----	--	------------------	---------	-------

2.0 quattro (85 kW | 2.0 Liter)

10.90 → 08.91	AAD		246-082-008-014C	SWP-M-C	T1: 1
---------------	-----	--	------------------	---------	-------

2.0 E 16V (101 kW | 2.0 Liter)

03.90 → 08.91	6A		246-082-008-014C	SWP-M-C	T1: 1
03.90 → 08.91	6A		246-086-001-002C	HLWP	T1: 3
03.90 → 09.91	6A		246-086-001-007C	HLWP	T1: 3b; T3: X11-246-003-014

2.0 E 16V quattro (101 kW | 2.0 Liter)

03.90 → 08.91	6A		246-082-008-014C	SWP-M-C	T1: 1
---------------	----	--	------------------	---------	-------

1.6 D (40 kW | 1.6 Liter)

02.87 → 07.89	JK		246-082-008-014C	SWP-M-C	T1: 1
09.86 → 08.91	JK		246-086-001-007C	HLWP	T1: 3b; T3: X11-246-003-014



			VDO		
Datum	Motorcode	Fahrgestell Nr.	Artikel Nr.	Artikelbez.	Information

AUDI**80 (89, 89Q, 8A, B3)****1.6 TD (59 kW | 1.6 Liter)**

04.88 → 08.91	RA / SB		246-082-008-014C	SWP-M-C	T1: 1
01.89 → 08.91	RA / SB		246-086-001-002C	HLWP	T1: 3
09.86 → 08.91	RA / SB		246-086-001-007C	HLWP	T1: 3b; T3: X11-246-003-014

1.9 D (50 kW | 1.9 Liter)

08.89 → 08.91	1Y		246-082-008-014C	SWP-M-C	T1: 1
08.89 → 08.91	1Y		246-086-001-002C	HLWP	T1: 3
08.89 → 08.91	1Y		246-086-001-007C	HLWP	T1: 3b; T3: X11-246-003-014

COUPE (89, 8B)**1.8 (82 kW | 1.8 Liter)**

08.89 → 07.91	DZ		246-082-008-014C	SWP-M-C	T1: 1
08.89 → 07.91	DZ		246-086-001-007C	HLWP	T1: 3b; T3: X11-246-003-014

2.0 (82 kW | 2.0 Liter)

03.90 → 07.90	3A		246-082-008-014C	SWP-M-C	T1: 1
---------------	----	--	------------------	---------	-------

2.0 (83 kW | 2.0 Liter)

05.89 → 03.90	3A		246-082-008-014C	SWP-M-C	T1: 1
---------------	----	--	------------------	---------	-------

2.0 (85 kW | 2.0 Liter)

08.89 → 07.91	AAD / ABK		246-082-008-014C	SWP-M-C	T1: 1
05.89 → 12.96	AAD / ABK		246-086-001-007C	HLWP	T1: 3b; T3: X11-246-003-014

2.0 16 V (101 kW | 2.0 Liter)

01.92 → 07.92	6A		246-082-008-014C	SWP-M-C	T1: 1
01.92 → 07.92	6A		246-086-001-007C	HLWP	T1: 3b; T3: X11-246-003-014

2.0 16 V (103 kW | 2.0 Liter)

08.92 → 12.96	ACE		246-086-001-007C	HLWP	T1: 3b; T3: X11-246-003-014
---------------	-----	--	------------------	------	--------------------------------

2.0 20 V (118 kW | 2.0 Liter)

08.89 → 07.91	NM		246-082-008-014C	SWP-M-C	T1: 1
---------------	----	--	------------------	---------	-------





2.0 20 V quattro (118 kW | 2.0 Liter)

08.89 → 07.91	NM		246-082-008-014C	SWP-M-C	T1: 1
08.89 → 07.91	NM		246-086-001-002C	HLWP	T1: 3
08.89 → 07.91	NM		246-086-001-007C	HLWP	T1: 3b; T3: X11-246-003-014

2.2 quattro (100 kW | 2.2 Liter)

11.88 → 07.91	KV		246-082-008-014C	SWP-M-C	T1: 1
11.88 → 07.91	KV		246-086-001-002C	HLWP	T1: 3
11.88 → 07.91	KV		246-086-001-007C	HLWP	T1: 3b; T3: X11-246-003-014



			VDO		
Datum	Motorcode	Fahrgestell Nr.	Artikel Nr.	Artikelbez.	Information

AUDI**COUPE (89, 8B)****S2 quattro (162 kW | 2.2 Liter)**

09.90 → 09.92	3B	→ M - 040 000	246-082-008-014C	SWP-M-C	T1: 1
09.90 → 09.92	3B		246-086-001-002C	HLWP	T1: 3
09.90 → 09.92	3B		246-086-001-007C	HLWP	T1: 3b; T3: X11-246-003-014

S2 quattro (169 kW | 2.2 Liter)

10.92 → 05.95	ABY		246-082-008-014C	SWP-M-C	T1: 1
10.92 → 05.95	ABY		246-086-001-002C	HLWP	T1: 3
10.92 → 12.96	ABY		246-086-001-007C	HLWP	T1: 3b; T3: X11-246-003-014

2.3 (98 kW | 2.3 Liter)

03.90 → 12.96	NG		246-086-001-007C	HLWP	T1: 3b; T3: X11-246-003-014
---------------	----	--	------------------	------	--------------------------------

2.3 quattro (98 kW | 2.3 Liter)

05.90 → 12.96	NG		246-086-001-007C	HLWP	T1: 3b; T3: X11-246-003-014
---------------	----	--	------------------	------	--------------------------------

2.3 (100 kW | 2.3 Liter)

11.88 → 05.94	NG	→ M - 040 000	246-082-008-014C	SWP-M-C	T1: 1
10.88 → 07.94	NG		246-086-001-007C	HLWP	T1: 3b; T3: X11-246-003-014

2.3 quattro (100 kW | 2.3 Liter)

11.88 → 12.92	NG	→ M - 040 000	246-082-008-014C	SWP-M-C	T1: 1
11.88 → 12.92	NG		246-086-001-002C	HLWP	T1: 3
11.88 → 12.92	NG		246-086-001-007C	HLWP	T1: 3b; T3: X11-246-003-014

2.3 20V (123 kW | 2.3 Liter)

08.90 → 07.91	7A		246-082-008-014C	SWP-M-C	T1: 1
08.90 → 07.91	7A		246-086-001-007C	HLWP	T1: 3b; T3: X11-246-003-014

2.3 20V quattro (123 kW | 2.3 Liter)

05.90 → 12.96	7A		246-086-001-007C	HLWP	T1: 3b; T3: X11-246-003-014
---------------	----	--	------------------	------	--------------------------------

2.3 20V (125 kW | 2.3 Liter)

08.89 → 07.91	7A		246-086-001-007C	HLWP	T1: 3b; T3: X11-246-003-014
---------------	----	--	------------------	------	--------------------------------

2.3 20V quattro (125 kW | 2.3 Liter)

11.88 → 07.91	7A		246-082-008-014C	SWP-M-C	T1: 1
11.88 → 07.91	7A		246-086-001-002C	HLWP	T1: 3
11.88 → 07.91	7A		246-086-001-007C	HLWP	T1: 3b; T3: X11-246-003-014

2.6 (110 kW | 2.6 Liter)

08.92 → 01.96	ABC		246-082-008-014C	SWP-M-C	T1: 1
07.94 → 01.96	ABC	S - 000 001 →	246-086-001-002C	HLWP	T1: 3
08.92 → 12.96	ABC		246-086-001-007C	HLWP	T1: 3b; T3: X11-246-003-014



			VDO		
Datum	Motorcode	Fahrgestell Nr.	Artikel Nr.	Artikelbez.	Information

AUDI**COUPE (89, 8B)****2.6 quattro (110 kW | 2.6 Liter)**

08.92 → 05.95	ABC		246-082-008-014C	SWP-M-C	T1: 1
08.92 → 05.95	ABC		246-086-001-002C	HLWP	T1: 3
08.92 → 12.96	ABC		246-086-001-007C	HLWP	T1: 3b; T3: X11-246-003-014

2.8 (128 kW | 2.8 Liter)

09.91 → 03.95	AAH		246-082-008-014C	SWP-M-C	T1: 1
07.94 → 03.95	AAH	S - 000 001 →	246-086-001-002C	HLWP	T1: 3
09.91 → 12.96	AAH		246-086-001-007C	HLWP	T1: 3b; T3: X11-246-003-014

2.8 quattro (128 kW | 2.8 Liter)

08.91 → 05.95	AAH		246-082-008-014C	SWP-M-C	T1: 1
08.91 → 05.95	AAH		246-086-001-002C	HLWP	T1: 3
08.91 → 12.96	AAH		246-086-001-007C	HLWP	T1: 3b; T3: X11-246-003-014

CABRIOLET (8G7, B4)**1.8 (92 kW | 1.8 Liter)**

01.97 → 08.00	ADR		246-082-008-014C	SWP-M-C	T1: 1
04.97 → 07.98	ADR		246-086-001-002C	HLWP	T1: 3

2.0 E (85 kW | 2.0 Liter)

01.93 → 07.98	ABK		246-082-008-014C	SWP-M-C	T1: 1
01.93 → 07.94	ABK		246-086-001-002C	HLWP	T1: 3

2.0 16V (103 kW | 2.0 Liter)

06.95 → 07.96	ACE		246-082-008-014C	SWP-M-C	T1: 1
06.95 → 07.96	ACE		246-086-001-002C	HLWP	T1: 3

2.3 E (98 kW | 2.3 Liter)

05.91 → 07.94	NG		246-082-008-014C	SWP-M-C	T1: 1
06.91 → 07.94	NG		246-086-001-002C	HLWP	T1: 3

2.6 (102 kW | 2.6 Liter)

05.95 → 07.96	ACZ		246-086-001-002C	HLWP	T1: 3
---------------	-----	--	------------------	------	-------

2.6 (110 kW | 2.6 Liter)

06.93 → 08.00	ABC		246-082-008-014C	SWP-M-C	T1: 1
01.94 → 12.94	ABC		246-086-001-002C	HLWP	T1: 3

2.8 (128 kW | 2.8 Liter)

11.92 → 08.00	AAH		246-082-008-014C	SWP-M-C	T1: 1
11.92 → 12.94	AAH		246-086-001-002C	HLWP	T1: 3

1.9 TDI (66 kW | 1.9 Liter)

06.95 → 08.00	1Z / AHU		246-082-008-014C	SWP-M-C	T1: 1
07.95 → 07.98	1Z / AHU		246-086-001-002C	HLWP	T1: 3



			VDO		
Datum	Motorcode	Fahrgestell Nr.	Artikel Nr.	Artikelbez.	Information

AUDI**80 (8C, B4)****1.6 (52 kW | 1.6 Liter)**

08.93 → 12.94	ABM	R - 000 001 →	246-086-001-002C	HLWP	T1: 3
09.91 → 12.94	ABM		246-086-001-007C	HLWP	T1: 3b; T3: X11-246-003-014

1.6 E (74 kW | 1.6 Liter)

08.93 → 12.94	ADA	R - 000 001 →	246-086-001-002C	HLWP	T1: 3
06.93 → 12.94	ADA		246-086-001-007C	HLWP	T1: 3b; T3: X11-246-003-014

2.0 (66 kW | 2.0 Liter)

08.93 → 12.94	ABT	R - 000 001 →	246-086-001-002C	HLWP	T1: 3
09.91 → 12.94	ABT		246-086-001-007C	HLWP	T1: 3b; T3: X11-246-003-014

2.0 E (85 kW | 2.0 Liter)

08.93 → 12.94	ABK	R - 000 001 →	246-086-001-002C	HLWP	T1: 3
09.91 → 12.94	ABK		246-086-001-007C	HLWP	T1: 3b; T3: X11-246-003-014

2.0 E quattro (85 kW | 2.0 Liter)

08.94 → 12.94	ABK	S - 000 001 →	246-086-001-002C	HLWP	T1: 3
09.91 → 12.94	ABK		246-086-001-007C	HLWP	T1: 3b; T3: X11-246-003-014

2.0 E 16V (103 kW | 2.0 Liter)

08.92 → 12.94	ACE		246-086-001-007C	HLWP	T1: 3b; T3: X11-246-003-014
---------------	-----	--	------------------	------	--------------------------------

2.0 E 16V quattro (103 kW | 2.0 Liter)

08.94 → 12.94	ACE	S - 000 001 →	246-086-001-002C	HLWP	T1: 3
04.92 → 12.94	ACE		246-086-001-007C	HLWP	T1: 3b; T3: X11-246-003-014

S2 quattro (169 kW | 2.2 Liter)

08.94 → 12.94	ABY	S - 000 001 →	246-086-001-002C	HLWP	T1: 3
02.93 → 12.94	ABY		246-086-001-007C	HLWP	T1: 3b; T3: X11-246-003-014

2.3 E (98 kW | 2.3 Liter)

08.93 → 12.94	NG	R - 000 001 →	246-086-001-002C	HLWP	T1: 3
09.91 → 12.94	NG		246-086-001-007C	HLWP	T1: 3b; T3: X11-246-003-014

2.3 E quattro (98 kW | 2.3 Liter)

08.94 → 12.94	NG	S - 000 001 →	246-086-001-002C	HLWP	T1: 3
09.91 → 12.94	NG		246-086-001-007C	HLWP	T1: 3b; T3: X11-246-003-014

2.6 (110 kW | 2.6 Liter)

08.93 → 12.94	ABC	R - 000 001 →	246-086-001-002C	HLWP	T1: 3
07.92 → 12.94	ABC		246-086-001-007C	HLWP	T1: 3b; T3: X11-246-003-014



			VDO		
Datum	Motorcode	Fahrgestell Nr.	Artikel Nr.	Artikelbez.	Information

AUDI**80 (8C, B4)**

2.6 quattro (110 kW 2.6 Liter)					
08.94 → 12.94	ABC		246-086-001-002C	HLWP	T1: 3
06.92 → 12.94	ABC		246-086-001-007C	HLWP	T1: 3b; T3: X11-246-003-014
2.8 (128 kW 2.8 Liter)					
08.93 → 12.94	AAH	R - 000 001 →	246-086-001-002C	HLWP	T1: 3
09.91 → 12.94	AAH		246-086-001-007C	HLWP	T1: 3b; T3: X11-246-003-014
2.8 quattro (128 kW 2.8 Liter)					
08.94 → 12.94	AAH		246-086-001-002C	HLWP	T1: 3
09.91 → 12.94	AAH		246-086-001-007C	HLWP	T1: 3b; T3: X11-246-003-014
1.9 TD (55 kW 1.9 Liter)					
08.93 → 12.94	AAZ	R - 000 001 →	246-086-001-002C	HLWP	T1: 3
09.91 → 12.94	AAZ		246-086-001-007C	HLWP	T1: 3b; T3: X11-246-003-014
1.9 TDI (66 kW 1.9 Liter)					
08.93 → 12.94	1Z	R - 000 001 →	246-086-001-002C	HLWP	T1: 3
09.91 → 12.94	1Z		246-086-001-007C	HLWP	T1: 3b; T3: X11-246-003-014

80 Avant (8C, B4)

1.6 E (74 kW 1.6 Liter)					
07.93 → 07.95	ADA		246-082-008-014C	SWP-M-C	T1: 1
08.93 → 07.95	ADA	R - 000 001 →	246-086-001-002C	HLWP	T1: 3
2.0 (66 kW 2.0 Liter)					
08.92 → 06.95	ABT		246-082-008-014C	SWP-M-C	T1: 1
08.93 → 06.95	ABT	R - 000 001 →	246-086-001-002C	HLWP	T1: 3
2.0 E (85 kW 2.0 Liter)					
08.92 → 07.95	ABK		246-082-008-014C	SWP-M-C	T1: 1
08.93 → 07.95	ABK	R - 000 001 →	246-086-001-002C	HLWP	T1: 3
2.0 E 16V (103 kW 2.0 Liter)					
02.93 → 07.95	ACE		246-082-008-014C	SWP-M-C	T1: 1
08.93 → 07.95	ACE	R - 000 001 →	246-086-001-002C	HLWP	T1: 3
2.0 E 16V quattro (103 kW 2.0 Liter)					
07.93 → 06.95	ACE		246-082-008-014C	SWP-M-C	T1: 1
08.94 → 06.95	ACE	S - 000 001 →	246-086-001-002C	HLWP	T1: 3
S2 quattro (169 kW 2.2 Liter)					
02.93 → 06.95	ABY		246-082-008-014C	SWP-M-C	T1: 1
08.94 → 06.95	ABY	S - 000 001 →	246-086-001-002C	HLWP	T1: 3
RS2 quattro (P1) (232 kW 2.2 Liter)					
03.94 → 05.95	ADU		246-082-008-014C	SWP-M-C	T1: 1
03.94 → 05.95	ADU		246-086-001-002C	HLWP	T1: 3



			VDO		
Datum	Motorcode	Fahrgestell Nr.	Artikel Nr.	Artikelbez.	Information

AUDI**80 Avant (8C, B4)****2.3 E (98 kW | 2.3 Liter)**

08.92 → 06.95	NG		246-082-008-014C	SWP-M-C	T1: 1
08.93 → 06.95	NG	R - 000 001 →	246-086-001-002C	HLWP	T1: 3

2.3 E quattro (98 kW | 2.3 Liter)

08.92 → 11.94	NG		246-082-008-014C	SWP-M-C	T1: 1
08.94 → 11.94	NG	S - 000 001 →	246-086-001-002C	HLWP	T1: 3

2.6 (110 kW | 2.6 Liter)

08.92 → 07.95	ABC		246-082-008-014C	SWP-M-C	T1: 1
08.93 → 07.95	ABC	R - 000 001 →	246-086-001-002C	HLWP	T1: 3

2.6 quattro (110 kW | 2.6 Liter)

08.92 → 06.95	ABC		246-082-008-014C	SWP-M-C	T1: 1
08.94 → 06.95	ABC		246-086-001-002C	HLWP	T1: 3

2.8 (128 kW | 2.8 Liter)

08.92 → 07.95	AAH		246-082-008-014C	SWP-M-C	T1: 1
08.93 → 07.95	AAH	R - 000 001 →	246-086-001-002C	HLWP	T1: 3

2.8 quattro (128 kW | 2.8 Liter)

08.92 → 06.95	AAH		246-082-008-014C	SWP-M-C	T1: 1
08.94 → 06.95	AAH		246-086-001-002C	HLWP	T1: 3

1.9 TD (55 kW | 1.9 Liter)

09.91 → 12.94	AAZ		246-082-008-014C	SWP-M-C	T1: 1
---------------	-----	--	------------------	---------	-------

1.9 TDI (66 kW | 1.9 Liter)

08.92 → 07.95	1Z		246-082-008-014C	SWP-M-C	T1: 1
08.93 → 07.95	1Z	R - 000 001 →	246-086-001-002C	HLWP	T1: 3

90 (81, 85, B2)**2.0 (83 kW | 2.0 Liter)**

03.86 → 03.87	SK		246-086-001-007C	HLWP	T1: 3b; T3: X11-246-003-014
---------------	----	--	------------------	------	--------------------------------

2.0 (85 kW | 2.0 Liter)

10.84 → 07.86	HP / JS		246-082-008-014C	SWP-M-C	T1: 1
10.84 → 03.87	HP / JS		246-086-001-007C	HLWP	T1: 3b; T3: X11-246-003-014

2.2 E quattro (88 kW | 2.2 Liter)

08.85 → 08.86	JT		246-082-008-014C	SWP-M-C	T1: 1
---------------	----	--	------------------	---------	-------

2.2 (100 kW | 2.2 Liter)

10.84 → 07.86	HY / KV		246-082-008-014C	SWP-M-C	T1: 1
10.84 → 03.87	HY / KV		246-086-001-007C	HLWP	T1: 3b; T3: X11-246-003-014

2.2 E quattro (100 kW | 2.2 Liter)

11.84 → 03.87	KV		246-082-008-014C	SWP-M-C	T1: 1
---------------	----	--	------------------	---------	-------

2.2 (85 kW | 2.2 Liter)

01.85 → 07.86	KX		246-082-008-014C	SWP-M-C	T1: 1
01.85 → 03.87	KX		246-086-001-007C	HLWP	T1: 3b; T3: X11-246-003-014



			VDO		
Datum	Motorcode	Fahrgestell Nr.	Artikel Nr.	Artikelbez.	Information

AUDI**90 (81, 85, B2)****1.6 TD (51 kW | 1.6 Liter)**

10.85 → 07.86	CY		246-082-008-014C	SWP-M-C	T1: 1
---------------	----	--	------------------	---------	-------

90 (89, 89Q, 8A, B3)**2.0 (85 kW | 2.0 Liter)**

07.88 → 07.89	PS		246-082-008-014C	SWP-M-C	T1: 1
07.88 → 09.91	PS		246-086-001-007C	HLWP	T1: 3b; T3: X11-246-003-014

2.0 20 V (118 kW | 2.0 Liter)

08.89 → 07.91	NM		246-082-008-014C	SWP-M-C	T1: 1
08.89 → 07.91	NM		246-086-001-007C	HLWP	T1: 3b; T3: X11-246-003-014

2.0 20 V quattro (118 kW | 2.0 Liter)

08.88 → 09.91	NM		246-082-008-014C	SWP-M-C	T1: 1
08.88 → 09.91	NM		246-086-001-007C	HLWP	T1: 3b; T3: X11-246-003-014

2.2 E (100 kW | 2.2 Liter)

04.87 → 07.91	KV		246-082-008-014C	SWP-M-C	T1: 1
04.87 → 07.91	KV		246-086-001-007C	HLWP	T1: 3b; T3: X11-246-003-014

2.2 E quattro (100 kW | 2.2 Liter)

04.87 → 09.91	KV		246-082-008-014C	SWP-M-C	T1: 1
04.87 → 09.91	KV		246-086-001-007C	HLWP	T1: 3b; T3: X11-246-003-014

2.3 E (98 kW | 2.3 Liter)

03.90 → 07.91	NG		246-086-001-007C	HLWP	T1: 3b; T3: X11-246-003-014
---------------	----	--	------------------	------	--------------------------------

2.3 E quattro (98 kW | 2.3 Liter)

04.90 → 09.91	NG		246-086-001-007C	HLWP	T1: 3b; T3: X11-246-003-014
---------------	----	--	------------------	------	--------------------------------

2.3 E (100 kW | 2.3 Liter)

04.87 → 07.91	NG		246-082-008-014C	SWP-M-C	T1: 1
04.87 → 07.91	NG		246-086-001-007C	HLWP	T1: 3b; T3: X11-246-003-014

2.3 E quattro (100 kW | 2.3 Liter)

04.87 → 07.91	NG		246-082-008-014C	SWP-M-C	T1: 1
04.87 → 07.91	NG		246-086-001-007C	HLWP	T1: 3b; T3: X11-246-003-014

2.3 E 20V (123 kW | 2.3 Liter)

04.90 → 07.91	7A		246-082-008-014C	SWP-M-C	T1: 1
04.90 → 07.91	7A		246-086-001-007C	HLWP	T1: 3b; T3: X11-246-003-014



			VDO		
Datum	Motorcode	Fahrgestell Nr.	Artikel Nr.	Artikelbez.	Information

AUDI**90 (89, 89Q, 8A, B3)****2.3 E 20V quattro (123 kW | 2.3 Liter)**

04.90 → 09.91	7A		246-086-001-007C	HLWP	T1: 3b; T3: X11-246-003-014
---------------	----	--	------------------	------	--------------------------------

2.3 E 20V (125 kW | 2.3 Liter)

08.88 → 07.89	7A		246-082-008-014C	SWP-M-C	T1: 1
08.88 → 07.91	7A		246-086-001-007C	HLWP	T1: 3b; T3: X11-246-003-014

2.3 E 20V quattro (125 kW | 2.3 Liter)

06.88 → 09.91	7A		246-082-008-014C	SWP-M-C	T1: 1
06.88 → 09.91	7A		246-086-001-007C	HLWP	T1: 3b; T3: X11-246-003-014

1.6 TD (59 kW | 1.6 Liter)

04.88 → 09.91	RA / SB		246-082-008-014C	SWP-M-C	T1: 1
04.87 → 09.91	RA / SB		246-086-001-007C	HLWP	T1: 3b; T3: X11-246-003-014

100 (C1)**1.6 (63 kW | 1.6 Liter)**

01.75 → 05.76	YM		246-082-008-014C	SWP-M-C	T1: 1
---------------	----	--	------------------	---------	-------

1.8 (59 kW | 1.8 Liter)

11.68 → 08.71			246-082-008-014C	SWP-M-C	T1: 1
---------------	--	--	------------------	---------	-------

1.8 (63 kW | 1.8 Liter)

09.71 → 07.74	ZU		246-082-008-014C	SWP-M-C	T1: 1
---------------	----	--	------------------	---------	-------

1.8 (66 kW | 1.8 Liter)

11.68 → 07.71			246-082-008-014C	SWP-M-C	T1: 1
---------------	--	--	------------------	---------	-------

1.8 LS (74 kW | 1.8 Liter)

10.70 → 05.76	ZZ		246-082-008-014C	SWP-M-C	T1: 1
---------------	----	--	------------------	---------	-------

1.9 GL (82 kW | 1.9 Liter)

09.71 → 05.76	ZJ		246-082-008-014C	SWP-M-C	T1: 1
---------------	----	--	------------------	---------	-------

100 (43, C2)**1.6 (63 kW | 1.6 Liter)**

08.76 → 07.81	YV		246-082-008-014C	SWP-M-C	T1: 1
08.76 → 07.82	YV		246-086-001-007C	HLWP	T1: 3b; T3: X11-246-003-014

1.9 (74 kW | 1.9 Liter)

08.80 → 07.82	WH		246-082-008-014C	SWP-M-C	T1: 1
08.80 → 07.82	WH		246-086-001-007C	HLWP	T1: 3b; T3: X11-246-003-014

2.0 (85 kW | 2.0 Liter)

06.76 → 07.78	WA		246-082-008-014C	SWP-M-C	T1: 1
06.76 → 08.78	WA		246-086-001-007C	HLWP	T1: 3b; T3: X11-246-003-014



			VDO		
Datum	Motorcode	Fahrgestell Nr.	Artikel Nr.	Artikelbez.	Information





AUDI**100 (43, C2)**

2.1 (85 kW 2.1 Liter)					
10.77 → 07.82	WE		246-082-008-014C	SWP-M-C	T1: 1
10.77 → 07.82	WE		246-086-001-007C	HLWP	T1: 3b; T3: X11-246-003-014
2.1 (100 kW 2.1 Liter)					
03.77 → 07.82	WC / WG		246-082-008-014C	SWP-M-C	T1: 1
03.77 → 07.82	WC / WG		246-086-001-007C	HLWP	T1: 3b; T3: X11-246-003-014
2.0 D (51 kW 2.0 Liter)					
08.78 → 07.82	CN		246-082-008-014C	SWP-M-C	T1: 1
08.78 → 07.82	CN		246-086-001-007C	HLWP	T1: 3b; T3: X11-246-003-014

100 Avant (43, C2)

1.6 (63 kW 1.6 Liter)					
07.77 → 07.82	YV		246-082-008-014C	SWP-M-C	T1: 1
07.77 → 02.83	YV		246-086-001-007C	HLWP	T1: 3b; T3: X11-246-003-014
1.9 (74 kW 1.9 Liter)					
08.80 → 07.82	WH		246-082-008-014C	SWP-M-C	T1: 1
08.80 → 07.82	WH		246-086-001-007C	HLWP	T1: 3b; T3: X11-246-003-014
2.0 (85 kW 2.0 Liter)					
09.77 → 07.78	WA		246-082-008-014C	SWP-M-C	T1: 1
08.77 → 07.80	WA		246-086-001-007C	HLWP	T1: 3b; T3: X11-246-003-014
2.1 (85 kW 2.1 Liter)					
09.77 → 02.83	WE		246-082-008-014C	SWP-M-C	T1: 1
07.77 → 02.83	WE		246-086-001-007C	HLWP	T1: 3b; T3: X11-246-003-014
2.1 (100 kW 2.1 Liter)					
09.77 → 07.82	WC / WG		246-082-008-014C	SWP-M-C	T1: 1
07.77 → 02.83	WC / WG		246-086-001-007C	HLWP	T1: 3b; T3: X11-246-003-014
2.0 D (51 kW 2.0 Liter)					
08.81 → 07.82	CN		246-075-021-006C	SWP-M-G	T1: 1; T2: B; T12
08.78 → 07.82	CN		246-082-008-014C	SWP-M-C	T1: 1
08.78 → 02.83	CN		246-086-001-007C	HLWP	T1: 3b; T3: X11-246-003-014



			VDO		
Datum	Motorcode	Fahrgestell Nr.	Artikel Nr.	Artikelbez.	Information

AUDI**100 (44, 44Q, C3)****1.8 (55 kW | 1.8 Liter)**

08.82 → 12.87	DR / RS		246-075-021-006C	SWP-M-G	T1: 1; T2: B; T12
08.82 → 12.87	DR / RS		246-082-008-014C	SWP-M-C	T1: 1
08.82 → 12.87	DR / RS		246-086-001-007C	HLWP	T1: 3b; T3: X11-246-003-014

1.8 (65 kW | 1.8 Liter)

02.86 → 07.88	SH		246-075-021-006C	SWP-M-G	T1: 1; T2: B; T12
02.86 → 07.88	SH		246-082-008-014C	SWP-M-C	T1: 1
02.86 → 07.88	SH		246-086-001-007C	HLWP	T1: 3b; T3: X11-246-003-014

1.8 quattro (65 kW | 1.8 Liter)

08.86 → 07.88	SH		246-075-021-006C	SWP-M-G	T1: 1; T2: B; T12
08.86 → 07.88	SH		246-082-008-014C	SWP-M-C	T1: 1
08.86 → 07.90	SH		246-086-001-007C	HLWP	T1: 3b; T3: X11-246-003-014

1.8 (66 kW | 1.8 Liter)

08.83 → 07.89	DS / JW / NP		246-075-021-006C	SWP-M-G	T1: 1; T2: B; T12
08.83 → 07.89	DS / JW / NP		246-082-008-014C	SWP-M-C	T1: 1
08.83 → 07.89	DS / JW / NP		246-086-001-007C	HLWP	T1: 3b; T3: X11-246-003-014

1.8 KAT (66 kW | 1.8 Liter)

04.85 → 07.90	4B / PH		246-075-021-006C	SWP-M-G	T1: 1; T2: B; T12
04.85 → 11.90	4B / PH		246-082-008-014C	SWP-M-C	T1: 1
03.85 → 11.90	4B / PH		246-086-001-007C	HLWP	T1: 3b; T3: X11-246-003-014

1.8 quattro (66 kW | 1.8 Liter)

10.84 → 07.88	JW / NP		246-075-021-006C	SWP-M-G	T1: 1; T2: B; T12
10.84 → 07.88	JW / NP		246-082-008-014C	SWP-M-C	T1: 1
10.84 → 07.88	JW / NP		246-086-001-007C	HLWP	T1: 3b; T3: X11-246-003-014

1.8 quattro KAT (66 kW | 1.8 Liter)

01.88 → 11.90	4B / PH		246-075-021-006C	SWP-M-G	T1: 1; T2: B; T12
01.88 → 11.90	4B / PH		246-082-008-014C	SWP-M-C	T1: 1
08.85 → 11.90	4B / PH		246-086-001-007C	HLWP	T1: 3b; T3: X11-246-003-014

1.9 (74 kW | 1.9 Liter)

08.82 → 07.84	WH		246-075-021-006C	SWP-M-G	T1: 1; T2: B; T12
08.82 → 07.84	WH		246-082-008-014C	SWP-M-C	T1: 1
08.82 → 07.84	WH		246-086-001-007C	HLWP	T1: 3b; T3: X11-246-003-014

2.0 (83 kW | 2.0 Liter)

08.86 → 11.87	SL		246-075-021-006C	SWP-M-G	T1: 1; T2: B; T12
08.86 → 11.87	SL		246-082-008-014C	SWP-M-C	T1: 1
08.86 → 11.87	SL		246-086-001-007C	HLWP	T1: 3b; T3: X11-246-003-014



			VDO		
Datum	Motorcode	Fahrgestell Nr.	Artikel Nr.	Artikelbez.	Information

AUDI**100 (44, 44Q, C3)****2.0 (85 kW | 2.0 Liter)**

08.84 → 12.87	KP		246-075-021-006C	SWP-M-G	T1: 1; T2: B; T12
08.84 → 12.87	KP		246-082-008-014C	SWP-M-C	T1: 1
08.84 → 12.87	KP		246-086-001-007C	HLWP	T1: 3b; T3: X11-246-003-014

2.0 KAT (85 kW | 2.0 Liter)

01.88 → 07.89	RT		246-075-021-006C	SWP-M-G	T1: 1; T2: B; T12
01.88 → 07.89	RT		246-082-008-014C	SWP-M-C	T1: 1
01.88 → 11.90	RT		246-086-001-007C	HLWP	T1: 3b; T3: X11-246-003-014

2.1 (100 kW | 2.1 Liter)

08.82 → 07.84			246-075-021-006C	SWP-M-G	T1: 1; T2: B; T12
08.82 → 07.84			246-082-008-014C	SWP-M-C	T1: 1
08.82 → 07.84			246-086-001-007C	HLWP	T1: 3b; T3: X11-246-003-014

2.2 (79 kW | 2.2 Liter)

08.82 → 07.84	WU		246-075-021-006C	SWP-M-G	T1: 1; T2: B
08.82 → 07.84	WU		246-082-008-014C	SWP-M-C	T1: 1
08.82 → 07.84	WU		246-086-001-007C	HLWP	T1: 3b

2.2 (85 kW | 2.2 Liter)

10.84 → 09.86	KZ		246-075-021-006C	SWP-M-G	T1: 1; T2: B; T12
10.84 → 09.86	KZ		246-082-008-014C	SWP-M-C	T1: 1
10.84 → 09.86	KZ		246-086-001-007C	HLWP	T1: 3b; T3: X11-246-003-014

2.2 E quattro (88 kW | 2.2 Liter)

08.85 → 07.86	PX		246-086-001-007C	HLWP	T1: 3b; T3: X11-246-003-014
---------------	----	--	------------------	------	--------------------------------

2.2 (96 kW | 2.2 Liter)

08.82 → 07.84	KF		246-082-008-014C	SWP-M-C	T1: 1
08.82 → 07.84	KF		246-086-001-007C	HLWP	T1: 3b

2.2 (101 kW | 2.2 Liter)

08.84 → 12.88	KU		246-075-021-006C	SWP-M-G	T1: 1; T2: B; T12
08.84 → 12.88	KU		246-082-008-014C	SWP-M-C	T1: 1
08.84 → 12.88	KU		246-086-001-007C	HLWP	T1: 3b; T3: X11-246-003-014

2.2 KAT (101 kW | 2.2 Liter)

08.89 → 07.90	KU		246-075-021-006C	SWP-M-G	T1: 1; T2: B; T12
08.89 → 07.90	KU		246-082-008-014C	SWP-M-C	T1: 1
06.89 → 11.90	KU		246-086-001-007C	HLWP	T1: 3b; T3: X11-246-003-014

2.2 quattro (101 kW | 2.2 Liter)

10.84 → 12.88	KU		246-075-021-006C	SWP-M-G	T1: 1; T2: B; T12
10.84 → 12.88	KU		246-082-008-014C	SWP-M-C	T1: 1
08.84 → 12.88	KU		246-086-001-007C	HLWP	T1: 3b; T3: X11-246-003-014



			VDO		
Datum	Motorcode	Fahrgestell Nr.	Artikel Nr.	Artikelbez.	Information

AUDI**100 (44, 44Q, C3)****2.2 quattro KAT (101 kW | 2.2 Liter)**

06.89 → 11.90	KU		246-086-001-007C	HLWP	T1: 3b; T3: X11-246-003-014
---------------	----	--	------------------	------	--------------------------------

2.2 E Turbo quattro (121 kW | 2.2 Liter)

08.86 → 11.90	MC		246-075-021-006C	SWP-M-G	T1: 1; T2: B; T12
08.86 → 11.90	MC		246-082-008-014C	SWP-M-C	T1: 1
08.86 → 11.90	MC		246-086-001-007C	HLWP	T1: 3b; T3: X11-246-003-014

2.2 Turbo (121 kW | 2.2 Liter)

08.86 → 11.90	MC		246-075-021-006C	SWP-M-G	T1: 1; T2: B; T12
08.86 → 11.90	MC		246-082-008-014C	SWP-M-C	T1: 1
08.86 → 11.90	MC		246-086-001-007C	HLWP	T1: 3b; T3: X11-246-003-014

2.3 E (98 kW | 2.3 Liter)

01.90 → 11.90			246-086-001-007C	HLWP	T1: 3b; T3: X11-246-003-014
---------------	--	--	------------------	------	--------------------------------

2.3 quattro (98 kW | 2.3 Liter)

01.90 → 11.90			246-086-001-007C	HLWP	T1: 3b; T3: X11-246-003-014
---------------	--	--	------------------	------	--------------------------------

2.3 E (100 kW | 2.3 Liter)

10.86 → 07.90	NF		246-075-021-006C	SWP-M-G	T1: 1; T2: B; T12
10.86 → 07.90	NF		246-082-008-014C	SWP-M-C	T1: 1
10.86 → 11.90	NF		246-086-001-007C	HLWP	T1: 3b; T3: X11-246-003-014

2.3 E quattro (100 kW | 2.3 Liter)

08.86 → 11.90	NF		246-075-021-006C	SWP-M-G	T1: 1; T2: B; T12
08.86 → 11.90	NF		246-082-008-014C	SWP-M-C	T1: 1
08.86 → 11.90	NF		246-086-001-007C	HLWP	T1: 3b; T3: X11-246-003-014

2.0 D (51 kW | 2.0 Liter)

08.82 → 01.88	CN		246-075-021-006C	SWP-M-G	T1: 1; T2: B; T12
08.82 → 07.88	CN		246-082-008-014C	SWP-M-C	T1: 1
08.82 → 07.88	CN		246-086-001-007C	HLWP	T1: 3b; T3: X11-246-003-014

2.0 D Turbo (64 kW | 2.0 Liter)

08.82 → 01.88	DE		246-075-021-006C	SWP-M-G	T1: 1; T2: B; T12
08.82 → 01.88	DE		246-082-008-014C	SWP-M-C	T1: 1
08.82 → 02.88	DE		246-086-001-007C	HLWP	T1: 3b; T3: X11-246-003-014

2.0 D Turbo (74 kW | 2.0 Liter)

03.88 → 11.90	NC		246-075-021-006C	SWP-M-G	T1: 1; T2: B; T12
03.88 → 11.90	NC		246-082-008-014C	SWP-M-C	T1: 1
03.88 → 11.90	NC		246-086-001-007C	HLWP	T1: 3b; T3: X11-246-003-014



			VDO		
Datum	Motorcode	Fahrgestell Nr.	Artikel Nr.	Artikelbez.	Information

AUDI**100 (44, 44Q, C3)****2.4 D (60 kW | 2.4 Liter)**

08.90 → 07.91	3D		246-075-021-006C	SWP-M-G	T1: 1; T2: B; T12
08.90 → 12.90	3D		246-082-008-014C	SWP-M-C	T1: 1
08.89 → 07.91	3D		246-086-001-007C	HLWP	T1: 3b; T3: X11-246-003-014

2.5 TDI (88 kW | 2.5 Liter)

01.90 → 11.90	1T		246-075-021-006C	SWP-M-G	T1: 1; T2: B; T12
01.90 → 11.90	1T		246-082-008-014C	SWP-M-C	T1: 1
01.90 → 11.90	1T		246-086-001-007C	HLWP	T1: 3b; T3: X11-246-003-014

100 Avant (44, 44Q, C3)**1.8 (55 kW | 1.8 Liter)**

08.82 → 12.87	DR / RS		246-075-021-006C	SWP-M-G	T1: 1; T2: B; T12
08.82 → 12.87	DR / RS		246-082-008-014C	SWP-M-C	T1: 1
08.82 → 12.87	DR / RS		246-086-001-007C	HLWP	T1: 3b; T3: X11-246-003-014

1.8 (65 kW | 1.8 Liter)

02.86 → 07.90	SH		246-075-021-006C	SWP-M-G	T1: 1; T2: B; T12
02.86 → 07.90	SH		246-082-008-014C	SWP-M-C	T1: 1
02.86 → 07.90	SH		246-086-001-007C	HLWP	T1: 3b; T3: X11-246-003-014

1.8 quattro (65 kW | 1.8 Liter)

08.86 → 07.90	SH		246-086-001-007C	HLWP	T1: 3b; T3: X11-246-003-014
---------------	----	--	------------------	------	--------------------------------

1.8 (66 kW | 1.8 Liter)

08.84 → 07.89	JW / NP		246-075-021-006C	SWP-M-G	T1: 1; T2: B; T12
08.84 → 07.89	JW / NP		246-082-008-014C	SWP-M-C	T1: 1
08.83 → 07.89	JW / NP		246-086-001-007C	HLWP	T1: 3b; T3: X11-246-003-014

1.8 KAT (66 kW | 1.8 Liter)

08.89 → 07.90	4B / PH		246-075-021-006C	SWP-M-G	T1: 1; T2: B; T12
08.89 → 07.90	4B / PH		246-082-008-014C	SWP-M-C	T1: 1
03.85 → 11.90	4B / PH		246-086-001-007C	HLWP	T1: 3b; T3: X11-246-003-014





1.8 quattro (66 kW | 1.8 Liter)

10.84 → 12.87	JW / NP		246-075-021-006C	SWP-M-G	T1: 1; T2: B; T12
10.84 → 12.87	JW / NP		246-082-008-014C	SWP-M-C	T1: 1
10.84 → 07.88	JW / NP		246-086-001-007C	HLWP	T1: 3b; T3: X11-246-003-014

1.8 quattro KAT (66 kW | 1.8 Liter)

08.85 → 10.90	4B / PH		246-086-001-007C	HLWP	T1: 3b; T3: X11-246-003-014
---------------	---------	--	------------------	------	--------------------------------



			VDO		
Datum	Motorcode	Fahrgestell Nr.	Artikel Nr.	Artikelbez.	Information

AUDI**100 Avant (44, 44Q, C3)****1.9 (74 kW | 1.9 Liter)**

02.83 → 07.84	WH		246-075-021-006C	SWP-M-G	T1: 1; T2: B; T12
02.83 → 07.84	WH		246-082-008-014C	SWP-M-C	T1: 1
02.83 → 07.84	WH		246-086-001-007C	HLWP	T1: 3b; T3: X11-246-003-014

2.0 (83 kW | 2.0 Liter)

09.86 → 11.87	SL		246-075-021-006C	SWP-M-G	T1: 1; T2: B; T12
09.86 → 11.87	SL		246-082-008-014C	SWP-M-C	T1: 1
09.86 → 11.87	SL		246-086-001-007C	HLWP	T1: 3b; T3: X11-246-003-014

2.0 E (85 kW | 2.0 Liter)

01.85 → 12.87	KP		246-075-021-006C	SWP-M-G	T1: 1; T2: B; T12
01.85 → 12.87	KP		246-082-008-014C	SWP-M-C	T1: 1
01.85 → 12.87	KP		246-086-001-007C	HLWP	T1: 3b; T3: X11-246-003-014

2.0 E KAT (85 kW | 2.0 Liter)

01.88 → 07.90	RT		246-075-021-006C	SWP-M-G	T1: 1; T2: B; T12
01.88 → 07.90	RT		246-082-008-014C	SWP-M-C	T1: 1
01.88 → 11.90	RT		246-086-001-007C	HLWP	T1: 3b; T3: X11-246-003-014

2.1 (100 kW | 2.1 Liter)

08.82 → 07.84	WC		246-075-021-006C	SWP-M-G	T1: 1; T2: B; T12
08.82 → 07.84	WC		246-082-008-014C	SWP-M-C	T1: 1
08.82 → 07.84	WC		246-086-001-007C	HLWP	T1: 3b; T3: X11-246-003-014

2.2 (85 kW | 2.2 Liter)

10.84 → 09.86	KZ		246-075-021-006C	SWP-M-G	T1: 1; T2: B; T12
10.84 → 09.86	KZ		246-082-008-014C	SWP-M-C	T1: 1
10.84 → 09.86	KZ		246-086-001-007C	HLWP	T1: 3b; T3: X11-246-003-014

2.2 E quattro (88 kW | 2.2 Liter)

08.85 → 07.86	PX		246-086-001-007C	HLWP	T1: 3b; T3: X11-246-003-014
---------------	----	--	------------------	------	--------------------------------





2.2 (101 kW | 2.2 Liter)

08.84 → 12.88	KU		246-075-021-006C	SWP-M-G	T1: 1; T2: B; T12
08.84 → 12.88	KU		246-082-008-014C	SWP-M-C	T1: 1
08.84 → 12.88	KU		246-086-001-007C	HLWP	T1: 3b; T3: X11-246-003-014

2.2 KAT (101 kW | 2.2 Liter)

06.89 → 11.90	KU		246-075-021-006C	SWP-M-G	T1: 1; T2: B; T12
08.89 → 07.90	KU		246-082-008-014C	SWP-M-C	T1: 1
06.89 → 11.90	KU		246-086-001-007C	HLWP	T1: 3b; T3: X11-246-003-014







			VDO		
Datum	Motorcode	Fahrgestell Nr.	Artikel Nr.	Artikelbez.	Information

AUDI**100 Avant (44, 44Q, C3)**

2.2 quattro (101 kW 2.2 Liter)					
10.84 → 12.88	KU		246-075-021-006C	SWP-M-G	T1: 1; T2: B; T12
10.84 → 12.88	KU		246-082-008-014C	SWP-M-C	T1: 1
08.84 → 12.88	KU		246-086-001-007C	HLWP	T1: 3b; T3: X11-246-003-014
2.2 quattro KAT (101 kW 2.2 Liter)					
06.89 → 11.90	KU		246-086-001-007C	HLWP	T1: 3b; T3: X11-246-003-014
2.2 Turbo (121 kW 2.2 Liter)					
08.86 → 07.90	MC		246-075-021-006C	SWP-M-G	T1: 1; T2: B; T12
08.86 → 07.90	MC		246-082-008-014C	SWP-M-C	T1: 1
08.86 → 11.90	MC		246-086-001-007C	HLWP	T1: 3b; T3: X11-246-003-014
2.2 Turbo quattro (121 kW 2.2 Liter)					
08.86 → 11.90	MC		246-075-021-006C	SWP-M-G	T1: 1; T2: B; T12
08.86 → 11.90	MC		246-082-008-014C	SWP-M-C	T1: 1
08.86 → 11.90	MC		246-086-001-007C	HLWP	T1: 3b; T3: X11-246-003-014
2.3 (98 kW 2.3 Liter)					
03.90 → 11.90			246-086-001-007C	HLWP	T1: 3b; T3: X11-246-003-014
2.3 quattro (98 kW 2.3 Liter)					
01.90 → 11.90			246-086-001-007C	HLWP	T1: 3b; T3: X11-246-003-014
2.3 (100 kW 2.3 Liter)					
10.86 → 07.90	NF		246-075-021-006C	SWP-M-G	T1: 1; T2: B; T12
10.86 → 07.90	NF		246-082-008-014C	SWP-M-C	T1: 1
08.86 → 11.90	NF		246-086-001-007C	HLWP	T1: 3b; T3: X11-246-003-014
2.3 E quattro (100 kW 2.3 Liter)					
08.86 → 11.90	NF		246-075-021-006C	SWP-M-G	T1: 1; T2: B; T12
08.86 → 11.90	NF		246-082-008-014C	SWP-M-C	T1: 1
08.86 → 11.90	NF		246-086-001-007C	HLWP	T1: 3b; T3: X11-246-003-014
2.0 D (51 kW 2.0 Liter)					
03.83 → 07.89	CN		246-075-021-006C	SWP-M-G	T1: 1; T2: B; T12
03.83 → 07.89	CN		246-082-008-014C	SWP-M-C	T1: 1
03.83 → 11.90	CN		246-086-001-007C	HLWP	T1: 3b; T3: X11-246-003-014
2.0 TD (64 kW 2.0 Liter)					
03.83 → 10.87	DE		246-075-021-006C	SWP-M-G	T1: 1; T2: B; T12
03.83 → 10.87	DE		246-082-008-014C	SWP-M-C	T1: 1
03.83 → 10.87	DE		246-086-001-007C	HLWP	T1: 3b; T3: X11-246-003-014



			VDO		
Datum	Motorcode	Fahrgestell Nr.	Artikel Nr.	Artikelbez.	Information

AUDI**100 Avant (44, 44Q, C3)****2.0 TD (74 kW | 2.0 Liter)**

03.88 → 07.90	NC		246-075-021-006C	SWP-M-G	T1: 1; T2: B; T12
03.88 → 07.90	NC		246-082-008-014C	SWP-M-C	T1: 1
03.88 → 11.90	NC		246-086-001-007C	HLWP	T1: 3b; T3: X11-246-003-014

2.4 D (60 kW | 2.4 Liter)

08.90 → 11.90	3D		246-075-021-006C	SWP-M-G	T1: 1; T2: B; T12
08.90 → 11.90	3D		246-082-008-014C	SWP-M-C	T1: 1
08.89 → 11.90	3D		246-086-001-007C	HLWP	T1: 3b; T3: X11-246-003-014

2.5 TDI (88 kW | 2.5 Liter)

01.90 → 07.90	1T		246-075-021-006C	SWP-M-G	T1: 1; T2: B; T12
01.90 → 07.90	1T		246-082-008-014C	SWP-M-C	T1: 1
01.90 → 11.90	1T		246-086-001-007C	HLWP	T1: 3b; T3: X11-246-003-014

100 (4A, C4)**2.0 (74 kW | 2.0 Liter)**

12.90 → 06.94	AAE		246-086-001-002C	HLWP	T1: 3
12.90 → 06.94	AAE		246-086-001-007C	HLWP	T1: 3b; T3: X11-246-003-014

2.0 E (85 kW | 2.0 Liter)

01.91 → 06.94	AAD / ABK		246-086-001-002C	HLWP	T1: 3
12.90 → 06.94	AAD / ABK		246-086-001-007C	HLWP	T1: 3b; T3: X11-246-003-014

2.0 E quattro (85 kW | 2.0 Liter)

12.90 → 07.92	AAD		246-086-001-007C	HLWP	T1: 3b; T3: X11-246-003-014
---------------	-----	--	------------------	------	--------------------------------

2.0 E 16V (101 kW | 2.0 Liter)

01.92 → 06.94	ACE		246-086-001-002C	HLWP	T1: 3
01.92 → 06.94	ACE		246-086-001-007C	HLWP	T1: 3b; T3: X11-246-003-014

2.0 E 16V quattro (103 kW | 2.0 Liter)

07.92 → 06.94	ACE		246-086-001-007C	HLWP	T1: 3b; T3: X11-246-003-014
---------------	-----	--	------------------	------	--------------------------------

S4 Turbo quattro (169 kW | 2.2 Liter)

08.91 → 06.94	AAN		246-086-001-007C	HLWP	T1: 3b; T3: X11-246-003-014
---------------	-----	--	------------------	------	--------------------------------

2.3 E (98 kW | 2.3 Liter)

12.90 → 06.94	AAR		246-086-001-002C	HLWP	T1: 3
12.90 → 06.94	AAR		246-086-001-007C	HLWP	T1: 3b; T3: X11-246-003-014



			VDO		
Datum	Motorcode	Fahrgestell Nr.	Artikel Nr.	Artikelbez.	Information

AUDI**100 (4A, C4)**

2.3 E quattro (98 kW 2.3 Liter)					
12.90 → 06.94	AAR		246-086-001-007C	HLWP	T1: 3b; T3: X11-246-003-014
2.6 (102 kW 2.6 Liter)					
07.93 → 06.94	ACZ		246-086-001-002C	HLWP	T1: 3
07.93 → 06.94	ACZ		246-086-001-007C	HLWP	T1: 3b; T3: X11-246-003-014
2.6 (110 kW 2.6 Liter)					
04.92 → 06.94	ABC		246-086-001-002C	HLWP	T1: 3
03.92 → 06.94	ABC		246-086-001-007C	HLWP	T1: 3b; T3: X11-246-003-014
2.6 quattro (110 kW 2.6 Liter)					
04.92 → 06.94	ABC		246-086-001-007C	HLWP	T1: 3b; T3: X11-246-003-014
2.8 E (128 kW 2.8 Liter)					
12.90 → 06.94	AAH		246-086-001-002C	HLWP	T1: 3
12.90 → 06.94	AAH		246-086-001-007C	HLWP	T1: 3b; T3: X11-246-003-014
2.8 E quattro (128 kW 2.8 Liter)					
07.92 → 06.94	AAH		246-082-008-014C	SWP-M-C	T1: 1
12.90 → 06.94	AAH		246-086-001-007C	HLWP	T1: 3b; T3: X11-246-003-014
S4 V8 quattro (206 kW 4.2 Liter)					
10.92 → 06.94	ABH		246-086-001-007C	HLWP	T1: 3b; T3: X11-246-003-014
S4 V8 quattro (213 kW 4.2 Liter)					
03.94 → 06.94	AEC		246-086-001-007C	HLWP	T1: 3b; T3: X11-246-003-014
2.4 D (60 kW 2.4 Liter)					
12.90 → 06.94	AAS		246-086-001-002C	HLWP	T1: 3
12.90 → 06.94	AAS		246-086-001-007C	HLWP	T1: 3b; T3: X11-246-003-014
2.5 TDI (85 kW 2.5 Liter)					
06.91 → 06.94	AAT / ABP		246-086-001-002C	HLWP	T1: 3
12.90 → 06.94	AAT / ABP		246-086-001-007C	HLWP	T1: 3b; T3: X11-246-003-014

100 Avant (4A, C4)

2.0 E (74 kW 2.0 Liter)					
10.91 → 06.94	AAE		246-082-008-014C	SWP-M-C	T1: 1
10.91 → 06.94	AAE		246-086-001-002C	HLWP	T1: 3
09.91 → 06.94	AAE		246-086-001-007C	HLWP	T1: 3b; T3: X11-246-003-014



			VDO		
Datum	Motorcode	Fahrgestell Nr.	Artikel Nr.	Artikelbez.	Information

AUDI**100 Avant (4A, C4)**

2.0 E (85 kW 2.0 Liter)					
10.91 → 06.94	AAD / ABK		246-082-008-014C	SWP-M-C	T1: 1
10.91 → 06.94	AAD / ABK		246-086-001-002C	HLWP	T1: 3
09.91 → 06.94	AAD / ABK		246-086-001-007C	HLWP	T1: 3b; T3: X11-246-003-014
2.0 E quattro (85 kW 2.0 Liter)					
12.90 → 07.92	AAD		246-086-001-007C	HLWP	T1: 3b; T3: X11-246-003-014
S4 Turbo quattro (169 kW 2.2 Liter)					
09.91 → 06.94	AAN		246-082-008-014C	SWP-M-C	T1: 1
09.91 → 06.94	AAN		246-086-001-007C	HLWP	T1: 3b; T3: X11-246-003-014
2.3 E (98 kW 2.3 Liter)					
10.91 → 06.94	AAR		246-082-008-014C	SWP-M-C	T1: 1
10.91 → 06.94	AAR		246-086-001-002C	HLWP	T1: 3
09.91 → 06.94	AAR		246-086-001-007C	HLWP	T1: 3b; T3: X11-246-003-014
2.3 E quattro (98 kW 2.3 Liter)					
09.91 → 06.94	AAR		246-082-008-014C	SWP-M-C	T1: 1
09.91 → 06.94	AAR		246-086-001-007C	HLWP	T1: 3b; T3: X11-246-003-014
2.6 (102 kW 2.6 Liter)					
07.93 → 06.94	ACZ		246-082-008-014C	SWP-M-C	T1: 1
07.93 → 06.94	ACZ		246-086-001-002C	HLWP	T1: 3
07.93 → 06.94	ACZ		246-086-001-007C	HLWP	T1: 3b; T3: X11-246-003-014
2.6 (110 kW 2.6 Liter)					
04.92 → 06.94	ABC		246-082-008-014C	SWP-M-C	T1: 1
04.92 → 06.94	ABC		246-086-001-002C	HLWP	T1: 3
03.92 → 06.94	ABC		246-086-001-007C	HLWP	T1: 3b; T3: X11-246-003-014
2.6 quattro (110 kW 2.6 Liter)					
07.92 → 06.94	ABC		246-082-008-014C	SWP-M-C	T1: 1
07.92 → 06.94	ABC		246-086-001-007C	HLWP	T1: 3b; T3: X11-246-003-014
2.8 E (128 kW 2.8 Liter)					
10.91 → 06.94	AAH		246-082-008-014C	SWP-M-C	T1: 1
10.91 → 06.94	AAH		246-086-001-002C	HLWP	T1: 3
09.91 → 06.94	AAH		246-086-001-007C	HLWP	T1: 3b; T3: X11-246-003-014
2.8 E quattro (128 kW 2.8 Liter)					
09.91 → 06.94	AAH		246-082-008-014C	SWP-M-C	T1: 1
09.91 → 06.94	AAH		246-086-001-007C	HLWP	T1: 3b; T3: X11-246-003-014



			VDO		
Datum	Motorcode	Fahrgestell Nr.	Artikel Nr.	Artikelbez.	Information

AUDI**100 Avant (4A, C4)**

S4 V8 quattro (206 kW 4.2 Liter)					
10.92 → 06.94	ABH		246-086-001-007C	HLWP	T1: 3b; T3: X11-246-003-014
S4 V8 quattro (213 kW 4.2 Liter)					
03.94 → 06.94	AEC		246-082-008-014C	SWP-M-C	T1: 1
03.94 → 06.94	AEC		246-086-001-007C	HLWP	T1: 3b; T3: X11-246-003-014
2.4 D (60 kW 2.4 Liter)					
10.91 → 06.94	AAS		246-082-008-014C	SWP-M-C	T1: 1
10.91 → 06.94	AAS		246-086-001-002C	HLWP	T1: 3
12.90 → 06.94	AAS		246-086-001-007C	HLWP	T1: 3b; T3: X11-246-003-014
2.5 TDI (85 kW 2.5 Liter)					
10.91 → 06.94	AAT / ABP		246-082-008-014C	SWP-M-C	T1: 1
10.91 → 06.94	AAT / ABP		246-086-001-002C	HLWP	T1: 3
12.90 → 06.94	AAT / ABP		246-086-001-007C	HLWP	T1: 3b; T3: X11-246-003-014

200 (43)

2.1 5 E (100 kW 2.1 Liter)					
10.79 → 09.82	WC		246-082-008-014C	SWP-M-C	T1: 1
10.79 → 09.82	WC		246-086-001-007C	HLWP	T1: 3b; T3: X11-246-003-014
2.1 5 T (125 kW 2.1 Liter)					
10.79 → 08.82	WJ		246-082-008-014C	SWP-M-C	T1: 1

200 (44, 44Q)

2.1 5 E (100 kW 2.1 Liter)					
08.83 → 07.84	WC		246-075-021-006C	SWP-M-G	T1: 1; T2: B
08.83 → 07.84	WC		246-082-008-014C	SWP-M-C	T1: 1
08.83 → 07.84	WC		246-086-001-007C	HLWP	T1: 3b; T3: X11-246-003-014
2.1 Turbo (134 kW 2.1 Liter)					
08.83 → 01.88	KG		246-075-021-006C	SWP-M-G	T1: 1; T2: B
08.83 → 01.88	KG		246-082-008-014C	SWP-M-C	T1: 1
08.83 → 01.88	KG		246-086-001-007C	HLWP	T1: 3b; T3: X11-246-003-014
2.1 Turbo quattro (134 kW 2.1 Liter)					
10.84 → 09.86	KG		246-075-021-006C	SWP-M-G	T1: 1; T2: B
10.84 → 09.86	KG		246-082-008-014C	SWP-M-C	T1: 1
08.83 → 09.86	KG		246-086-001-007C	HLWP	T1: 3b; T3: X11-246-003-014



			VDO		
Datum	Motorcode	Fahrgestell Nr.	Artikel Nr.	Artikelbez.	Information

AUDI**200 (44, 44Q)****2.2 (101 kW | 2.2 Liter)**

08.84 → 07.85	KU		246-075-021-006C	SWP-M-G	T1: 1; T2: B
08.84 → 07.85	KU		246-082-008-014C	SWP-M-C	T1: 1
08.84 → 07.85	KU		246-086-001-007C	HLWP	T1: 3b; T3: X11-246-003-014

2.2 Turbo (121 kW | 2.2 Liter)

08.85 → 01.88	MC		246-075-021-006C	SWP-M-G	T1: 1; T2: B
08.85 → 12.90	MC		246-082-008-014C	SWP-M-C	T1: 1
08.85 → 09.91	MC		246-086-001-007C	HLWP	T1: 3b; T3: X11-246-003-014

2.2 Turbo quattro (121 kW | 2.2 Liter)

08.85 → 11.90	MC		246-082-008-014C	SWP-M-C	T1: 1
01.85 → 12.91	MC		246-086-001-007C	HLWP	T1: 3b; T3: X11-246-003-014

2.2 Turbo (140 kW | 2.2 Liter)

02.88 → 12.90	2B		246-082-008-014C	SWP-M-C	T1: 1
02.88 → 12.90	2B		246-086-001-007C	HLWP	T1: 3b; T3: X11-246-003-014

2.2 Turbo (147 kW | 2.2 Liter)

02.88 → 12.90	1B		246-086-001-007C	HLWP	T1: 3b; T3: X11-246-003-014
---------------	----	--	------------------	------	--------------------------------

2.2 Turbo quattro (147 kW | 2.2 Liter)

02.88 → 11.90	1B		246-082-008-014C	SWP-M-C	T1: 1
02.88 → 11.90	1B		246-086-001-007C	HLWP	T1: 3b; T3: X11-246-003-014

2.2 20V Turbo quattro (162 kW | 2.2 Liter)

08.89 → 11.90	3B		246-082-008-014C	SWP-M-C	T1: 1
03.89 → 12.90	3B		246-086-001-007C	HLWP	T1: 3b; T3: X11-246-003-014

2.3 (100 kW | 2.3 Liter)

08.88 → 12.90	NF		246-082-008-014C	SWP-M-C	T1: 1
11.86 → 09.91	NF		246-086-001-007C	HLWP	T1: 3b; T3: X11-246-003-014

200 Avant (44, 44Q)**2.1 Turbo quattro (134 kW | 2.1 Liter)**

10.84 → 01.88	KG		246-075-021-006C	SWP-M-G	T1: 1; T2: B
09.83 → 01.88	KG		246-082-008-014C	SWP-M-C	T1: 1
09.83 → 01.88	KG		246-086-001-007C	HLWP	T1: 3b; T3: X11-246-003-014

2.2 Turbo (121 kW | 2.2 Liter)

08.85 → 09.91	MC		246-086-001-007C	HLWP	T1: 3b; T3: X11-246-003-014
---------------	----	--	------------------	------	--------------------------------



			VDO		
Datum	Motorcode	Fahrgestell Nr.	Artikel Nr.	Artikelbez.	Information

AUDI

200 Avant (44, 44Q)

2.2 Turbo quattro (121 kW | 2.2 Liter)

01.85 → 11.90	MC		246-082-008-014C	SWP-M-C	T1: 1
09.83 → 12.90	MC		246-086-001-007C	HLWP	T1: 3b; T3: X11-246-003-014

2.2 Turbo quattro (147 kW | 2.2 Liter)

02.88 → 11.90	1B		246-082-008-014C	SWP-M-C	T1: 1
02.88 → 12.91	1B		246-086-001-007C	HLWP	T1: 3b; T3: X11-246-003-014

2.2 20V Turbo quattro (162 kW | 2.2 Liter)

07.89 → 12.90	3B		246-082-008-014C	SWP-M-C	T1: 1
07.89 → 12.90	3B		246-086-001-007C	HLWP	T1: 3b; T3: X11-246-003-014

2.3 (100 kW | 2.3 Liter)

03.89 → 11.90	NF		246-082-008-014C	SWP-M-C	T1: 1
11.86 → 09.91	NF		246-086-001-007C	HLWP	T1: 3b; T3: X11-246-003-014

NSU RO 80

RO 80 (85 kW | 1.0 Liter)

10.67 → 07.77	KKM	→ 824 2202 220	246-075-021-006C	SWP-M-G	T1: 1; T2: B
---------------	-----	----------------	------------------	---------	--------------

BMW

1 (E87)

116 i (85 kW | 1.6 Liter)

09.04 →	N45B16A		246-082-008-025G	SWP-M-C	T1: 3
09.04 →	N45B16A		246-086-001-007C	HLWP	T1: 3b

118i (95 kW | 2.0 Liter)

09.04 →	N42B20B		246-082-008-025G	SWP-M-C	T1: 3
09.04 →	N42B20B		246-086-001-007C	HLWP	T1: 3b

120 i (110 kW | 2.0 Liter)

09.04 →	N42B20A		246-082-008-025G	SWP-M-C	T1: 3
09.04 →	N42B20A		246-086-001-007C	HLWP	T1: 3b

130 i (195 kW | 3.0 Liter)

09.05 →	N52B30A		246-082-008-025G	SWP-M-C	T1: 3
---------	---------	--	------------------	---------	-------

118 d (90 kW | 2.0 Liter)

09.04 →	M47N204D4		246-082-008-025G	SWP-M-C	T1: 3
09.04 →	M47N204D4		246-086-001-007C	HLWP	T1: 3b

120 d (120 kW | 2.0 Liter)

09.04 →	M47N204D4		246-082-008-025G	SWP-M-C	T1: 3
09.04 →	M47N204D4		246-086-001-007C	HLWP	T1: 3b



			VDO		
Datum	Motorcode	Fahrgestell Nr.	Artikel Nr.	Artikelbez.	Information

BMW**3 (E30)****316 (Ecotronic) (66 kW | 1.8 Liter)**

09.83 → 12.90	M 10 B 18 (2BE)		246-080-013-001Z	N-H	
---------------	-----------------	--	------------------	-----	--

316 (66 kW | 1.8 Liter)

09.82 → 12.87	M 10 B 18 (2B4)		246-080-013-001Z	N-H	
---------------	-----------------	--	------------------	-----	--

3 Touring (E30)**320 i (95 kW | 2.0 Liter)**

01.88 → 12.91	M 20 B 20 (Motronic,Kat.)		246-080-013-001Z	N-H	
---------------	---------------------------	--	------------------	-----	--

3 (E36)**316 i (75 kW | 1.6 Liter)**

11.97 → 02.98	M 43 B 16		246-082-008-025G	SWP-M-C	T1: 3
---------------	-----------	--	------------------	---------	-------

318 i (85 kW | 1.8 Liter)

11.97 → 02.98	M 43 B 18		246-082-008-025G	SWP-M-C	T1: 3
---------------	-----------	--	------------------	---------	-------

318 is (103 kW | 1.9 Liter)

11.97 → 02.98	M 44 B 19		246-082-008-025G	SWP-M-C	T1: 3
---------------	-----------	--	------------------	---------	-------

320 i (110 kW | 2.0 Liter)

09.90 → 02.98	M 50 B (20 6 S1) / M 50 B (20 6 S2) Vanos / M 52 B (20 6 S3) Vanos		246-069-059-001Z	N	
---------------	--------------------------------------------------------------------------	--	------------------	---	--

09.90 → 02.98	M 50 B (20 6 S1) / M 50 B (20 6 S2) Vanos / M 52 B (20 6 S3) Vanos		246-080-013-003Z	N-H	
---------------	--------------------------------------------------------------------------	--	------------------	-----	--

11.97 → 02.98	M 50 B (20 6 S1) / M 50 B (20 6 S2) Vanos / M 52 B (20 6 S3) Vanos		246-082-008-025G	SWP-M-C	T1: 3
---------------	--------------------------------------------------------------------------	--	------------------	---------	-------

09.97 → 02.98	M 50 B (20 6 S1) / M 50 B (20 6 S2) Vanos / M 52 B (20 6 S3) Vanos		246-086-001-007C	HLWP	T1: 3b
---------------	--------------------------------------------------------------------------	--	------------------	------	--------

323 i 2.5 (125 kW | 2.5 Liter)

03.95 → 02.98	M 52 B 25 (Vanos)		246-069-059-001Z	N	
---------------	-------------------	--	------------------	---	--

11.97 → 02.98	M 52 B 25 (Vanos)		246-082-008-025G	SWP-M-C	T1: 3
---------------	-------------------	--	------------------	---------	-------

09.97 → 02.98	M 52 B 25 (Vanos)		246-086-001-007C	HLWP	T1: 3b
---------------	-------------------	--	------------------	------	--------

325 i (141 kW | 2.5 Liter)

09.90 → 09.95	M 50 B 25 / M 52 B 25 (Vanos)		246-069-059-001Z	N	
---------------	----------------------------------	--	------------------	---	--

328 i (142 kW | 2.8 Liter)

01.95 → 02.98	M 52 B 28		246-069-059-001Z	N	
---------------	-----------	--	------------------	---	--

11.97 → 02.98	M 52 B 28		246-082-008-025G	SWP-M-C	T1: 3
---------------	-----------	--	------------------	---------	-------





09.97 → 02.98	M 52 B 28		246-086-001-007C	HLWP	T1: 3b
---------------	-----------	--	------------------	------	--------

M3 3.0 (210 kW | 3.0 Liter)

08.94 → 09.95	S 50 B 30		246-069-059-001Z	N	
---------------	-----------	--	------------------	---	--

08.94 → 09.95	S 50 B 30		246-082-008-025G	SWP-M-C	T1: 3
---------------	-----------	--	------------------	---------	-------



			VDO		
Datum	Motorcode	Fahrgestell Nr.	Artikel Nr.	Artikelbez.	Information

BMW**3 (E36)****M3 3.2 (236 kW | 3.2 Liter)**

09.95 → 02.98	S 50 B 32		246-069-059-001Z	N	
09.97 → 02.98	S 50 B 32		246-082-008-025G	SWP-M-C	T1: 3
09.97 → 02.98	S 50 B 32		246-086-001-007C	HLWP	T1: 3b

318 tds (66 kW | 1.7 Liter)

11.97 → 02.98	M 41 D 18 (Inter.)		246-082-008-025G	SWP-M-C	T1: 3
---------------	--------------------	--	------------------	---------	-------

325 td (85 kW | 2.5 Liter)

09.91 → 02.98	M 51 D 25		246-069-059-001Z	N	
11.97 → 02.98	M 51 D 25		246-082-008-025G	SWP-M-C	T1: 3
09.97 → 02.98	M 51 D 25		246-086-001-007C	HLWP	T1: 3b

325 tds (105 kW | 2.5 Liter)

05.93 → 02.98	M 51 D 25 (Inter.)		246-069-059-001Z	N	
11.97 → 02.98	M 51 D 25 (Inter.)		246-082-008-025G	SWP-M-C	T1: 3
09.97 → 02.98	M 51 D 25 (Inter.)		246-086-001-007C	HLWP	T1: 3b

3 Compact (E36)**316 i (75 kW | 1.6 Liter)**

03.94 → 08.00	M 43 B 16		246-069-059-001Z	N	
03.94 → 08.00	M 43 B 16		246-080-013-003Z	N-H	
11.97 → 08.00	M 43 B 16		246-082-008-025G	SWP-M-C	T1: 3
03.94 → 08.00	M 43 B 16		246-083-002-022G	SWP-D-C	T1: 3; T8
09.97 → 08.00	M 43 B 16		246-086-001-007C	HLWP	T1: 3b

316 g (75 kW | 1.6 Liter)

12.95 → 08.00			246-069-059-001Z	N	
11.97 → 08.00			246-082-008-025G	SWP-M-C	T1: 3
12.95 → 08.00			246-083-002-022G	SWP-D-C	T1: 3; T8
09.97 → 08.00			246-086-001-007C	HLWP	T1: 3b

318 ti (103 kW | 1.8 Liter)

11.94 → 08.95	M 42 B 18		246-069-059-001Z	N	
11.94 → 08.95	M 42 B 18		246-083-002-022G	SWP-D-C	T1: 3; T8





316 i (77 kW | 1.9 Liter)

12.98 → 08.00	M43164E3		246-069-059-001Z	N	
12.98 → 08.00	M43164E3		246-080-013-003Z	N-H	
01.99 → 08.00	M43164E3		246-082-008-025G	SWP-M-C	T1: 3
12.98 → 08.00	M43164E3		246-083-002-022G	SWP-D-C	T1: 3; T8
12.98 → 08.00	M43164E3		246-086-001-007C	HLWP	T1: 3b

318 ti (103 kW | 1.9 Liter)

07.95 → 08.00	M 44 B 19		246-069-059-001Z	N	
11.97 → 12.98	M 44 B 19		246-082-008-025G	SWP-M-C	T1: 3
07.95 → 08.00	M 44 B 19		246-083-002-022G	SWP-D-C	T1: 3; T8
09.97 → 08.00	M 44 B 19		246-086-001-007C	HLWP	T1: 3b



			VDO		
Datum	Motorcode	Fahrgestell Nr.	Artikel Nr.	Artikelbez.	Information

BMW**3 Compact (E36)****323 ti (125 kW | 2.5 Liter)**

08.97 → 08.00	M 52 B 25 (Vanos)		246-069-059-001Z	N	
11.97 → 12.98	M 52 B 25 (Vanos)		246-082-008-025G	SWP-M-C	T1: 3
08.97 → 08.00	M 52 B 25 (Vanos)		246-083-002-022G	SWP-D-C	T1: 3; T8
09.97 → 08.00	M 52 B 25 (Vanos)		246-086-001-007C	HLWP	T1: 3b

318 tds (66 kW | 1.7 Liter)

01.95 → 08.00	M 41 D 18 (Inter.)		246-069-059-001Z	N	
11.97 → 08.00	M 41 D 18 (Inter.)		246-082-008-025G	SWP-M-C	T1: 3
01.95 → 08.00	M 41 D 18 (Inter.)		246-083-002-022G	SWP-D-C	T1: 3; T8
09.97 → 08.00	M 41 D 18 (Inter.)		246-086-001-007C	HLWP	T1: 3b

3 Coupe (E36)**316 i (75 kW | 1.6 Liter)**

11.97 → 04.99	M 43 B 16		246-082-008-025G	SWP-M-C	T1: 3
---------------	-----------	--	------------------	---------	-------

318 is (103 kW | 1.9 Liter)

11.97 → 04.99	M 44 B 19		246-082-008-025G	SWP-M-C	T1: 3
---------------	-----------	--	------------------	---------	-------

320 i (110 kW | 2.0 Liter)

11.97 → 04.99	M 50 B (20 6 S1) / M 50 B (20 6 S2) Vanos / M 52 B (20 6 S3) Vanos		246-082-008-025G	SWP-M-C	T1: 3
---------------	--------------------------------------------------------------------------	--	------------------	---------	-------

323 i 2.5 (125 kW | 2.5 Liter)

11.97 → 04.99	M 52 B 25 (Vanos)		246-082-008-025G	SWP-M-C	T1: 3
---------------	-------------------	--	------------------	---------	-------

325 i (141 kW | 2.5 Liter)

11.97 → 04.99	M 52 B 25 (Vanos)		246-082-008-025G	SWP-M-C	T1: 3
---------------	-------------------	--	------------------	---------	-------

328 i (142 kW | 2.8 Liter)

11.97 → 04.99	M 52 B 28		246-082-008-025G	SWP-M-C	T1: 3
---------------	-----------	--	------------------	---------	-------

M3 3.2 (236 kW | 3.2 Liter)

11.97 → 04.99	S 50 B 32		246-082-008-025G	SWP-M-C	T1: 3
---------------	-----------	--	------------------	---------	-------

3 Cabriolet (E36)**318 i (85 kW | 1.8 Liter)**

01.94 → 04.99	M 43 B 18		246-069-059-001Z	N	
11.97 → 04.99	M 43 B 18		246-082-008-025G	SWP-M-C	T1: 3
09.97 → 04.99	M 43 B 18		246-086-001-007C	HLWP	T1: 3b

320 i (110 kW | 2.0 Liter)

12.93 → 04.99	M 50 B (20 6 S2) Vanos / M 52 B (20 6 S3) Vanos		246-069-059-001Z	N	
11.97 → 04.99	M 50 B (20 6 S2) Vanos / M 52 B (20 6 S3) Vanos		246-082-008-025G	SWP-M-C	T1: 3
09.97 → 04.99	M 50 B (20 6 S2) Vanos / M 52 B (20 6 S3) Vanos		246-086-001-007C	HLWP	T1: 3b



			VDO		
Datum	Motorcode	Fahrgestell Nr.	Artikel Nr.	Artikelbez.	Information

BMW**3 Cabriolet (E36)**

323 i 2.5 (125 kW 2.5 Liter)					
06.95 → 04.99	M 52 B 25 (Vanos)		246-069-059-001Z	N	
11.97 → 04.99	M 52 B 25 (Vanos)		246-082-008-025G	SWP-M-C	T1: 3
09.97 → 04.99	M 52 B 25 (Vanos)		246-086-001-007C	HLWP	T1: 3b
325 i (141 kW 2.5 Liter)					
03.93 → 03.95	M 50 B 25		246-069-059-001Z	N	
328 i (142 kW 2.8 Liter)					
03.95 → 04.99	M 52 B 28		246-069-059-001Z	N	
11.97 → 04.99	M 52 B 28		246-082-008-025G	SWP-M-C	T1: 3
09.97 → 04.99	M 52 B 28		246-086-001-007C	HLWP	T1: 3b
M3 3.0 (210 kW 3.0 Liter)					
01.94 → 10.95	S 50 B 30		246-069-059-001Z	N	
M3 3.2 (236 kW 3.2 Liter)					
10.95 → 04.99	S 50 B 32		246-069-059-001Z	N	
09.97 → 04.99	S 50 B 32		246-082-008-025G	SWP-M-C	T1: 3
09.97 → 04.99	S 50 B 32		246-086-001-007C	HLWP	T1: 3b





3 Touring (E36)

316 i (75 kW 1.6 Liter)					
11.97 → 09.99	M 43 B 16		246-082-008-025G	SWP-M-C	T1: 3
318 i (85 kW 1.8 Liter)					
11.97 → 09.99	M 43 B 18		246-082-008-025G	SWP-M-C	T1: 3
320 i (110 kW 2.0 Liter)					
01.95 → 10.99	M 52 B (20 6 S3) Vanos		246-069-059-001Z	N	
01.95 → 10.99	M 52 B (20 6 S3) Vanos		246-080-013-003Z	N-H	
11.97 → 09.99	M 52 B (20 6 S3) Vanos		246-082-008-025G	SWP-M-C	T1: 3
323 i 2.5 (125 kW 2.5 Liter)					
09.95 → 10.99	M 52 B 25 (Vanos)		246-069-059-001Z	N	
11.97 → 09.99	M 52 B 25 (Vanos)		246-082-008-025G	SWP-M-C	T1: 3
328 i (142 kW 2.8 Liter)					
01.95 → 10.99	M 52 B 28		246-069-059-001Z	N	
11.97 → 09.99	M 52 B 28		246-082-008-025G	SWP-M-C	T1: 3
318 tds (66 kW 1.7 Liter)					
11.97 → 09.99	M 41 D 18 (Inter.)		246-082-008-025G	SWP-M-C	T1: 3
325 tds (105 kW 2.5 Liter)					
01.95 → 10.99	M 51 D 25 (Inter.)		246-069-059-001Z	N	
11.97 → 09.99	M 51 D 25 (Inter.)		246-082-008-025G	SWP-M-C	T1: 3

3 (E46)

316 i (77 kW 1.6 Liter)					
04.00 → 02.05	M 43 B 16 (16 4 E3)		246-082-008-025G	SWP-M-C	T1: 3
04.00 → 02.05	M 43 B 16 (16 4 E3)		246-086-001-007C	HLWP	T1: 3b







			VDO		
Datum	Motorcode	Fahrgestell Nr.	Artikel Nr.	Artikelbez.	Information

BMW**3 (E46)**

316 i (85 kW 1.6 Liter)					
06.02 → 02.05	N45B16A		246-082-008-025G	SWP-M-C	T1: 3
06.02 → 02.05	N45B16A		246-086-001-007C	HLWP	T1: 3b
316 i (85 kW 1.8 Liter)					
02.02 → 02.05	N 42 B 18		246-082-008-025G	SWP-M-C	T1: 3
02.02 → 02.05	N 42 B 18		246-086-001-007C	HLWP	T1: 3b
316 i (77 kW 1.9 Liter)					
01.99 → 02.05	M43164E3		246-082-008-025G	SWP-M-C	T1: 3
318 i (87 kW 1.9 Liter)					
03.98 → 09.01	M 43 B 19		246-082-008-025G	SWP-M-C	T1: 3
318 i (105 kW 2.0 Liter)					
09.01 → 02.05	N 42 B 20		246-082-008-025G	SWP-M-C	T1: 3
09.01 → 02.05	N 42 B 20		246-086-001-007C	HLWP	T1: 3b
320 i (110 kW 2.0 Liter)					
03.98 → 09.00	M 52 B (20 6 S3) Vanos		246-082-008-025G	SWP-M-C	T1: 3
03.98 → 09.00	M 52 B (20 6 S3) Vanos		246-086-001-007C	HLWP	T1: 3b
320 i (125 kW 2.2 Liter)					
09.00 → 02.05	M54226S1		246-082-008-025G	SWP-M-C	T1: 3
09.00 → 02.05	M54226S1		246-086-001-007C	HLWP	T1: 3b
323 i (125 kW 2.5 Liter)					
03.98 → 09.00	M 52 B 25 (Vanos)		246-082-008-025G	SWP-M-C	T1: 3
03.98 → 09.00	M 52 B 25 (Vanos)		246-086-001-007C	HLWP	T1: 3b
325 i (141 kW 2.5 Liter)					
09.00 → 02.05	M54256S5		246-082-008-025G	SWP-M-C	T1: 3
09.00 → 02.05	M54256S5		246-086-001-007C	HLWP	T1: 3b
325 xi (141 kW 2.5 Liter)					
09.00 → 02.05	M54256S5		246-082-008-025G	SWP-M-C	T1: 3
09.00 → 02.05	M54256S5		246-086-001-007C	HLWP	T1: 3b
328 i (142 kW 2.8 Liter)					
02.98 → 06.00	M 52 B 28		246-082-008-025G	SWP-M-C	T1: 3
02.98 → 06.00	M 52 B 28		246-086-001-007C	HLWP	T1: 3b
330 i (170 kW 3.0 Liter)					
08.00 → 02.05	M54306S3		246-082-008-025G	SWP-M-C	T1: 3
06.00 → 02.05	M54306S3		246-086-001-007C	HLWP	T1: 3b
330 xi (170 kW 3.0 Liter)					
08.00 → 02.05	M54306S3		246-082-008-025G	SWP-M-C	T1: 3
06.00 → 02.05	M54306S3		246-086-001-007C	HLWP	T1: 3b
318 d (85 kW 2.0 Liter)					
09.01 → 03.03	M47204D1		246-082-008-025G	SWP-M-C	T1: 3
09.01 → 03.03	M47204D1		246-086-001-007C	HLWP	T1: 3b
318 d (85 kW 2.0 Liter)					
03.03 → 02.05	M47N204D4		246-082-008-025G	SWP-M-C	T1: 3
03.03 → 02.05	M47N204D4		246-086-001-007C	HLWP	T1: 3b



			VDO		
Datum	Motorcode	Fahrgestell Nr.	Artikel Nr.	Artikelbez.	Information

BMW**3 (E46)****320 d (100 kW | 2.0 Liter)**

04.98 → 09.01	M 47 D 20 / M47204D1		246-082-008-025G	SWP-M-C	T1: 3
04.98 → 09.01	M 47 D 20 / M47204D1		246-086-001-007C	HLWP	T1: 3b

320 d (110 kW | 2.0 Liter)

09.01 → 02.05	M47N204D4		246-082-008-025G	SWP-M-C	T1: 3
09.01 → 02.05	M47N204D4		246-086-001-007C	HLWP	T1: 3b

330 d (135 kW | 3.0 Liter)

10.99 → 02.05	M 57 D 30		246-082-008-025G	SWP-M-C	T1: 3
10.99 → 02.05	M 57 D 30		246-086-001-007C	HLWP	T1: 3b

330 xd (135 kW | 3.0 Liter)

06.00 → 02.05	M 57 D 30		246-082-008-025G	SWP-M-C	T1: 3
06.00 → 02.05	M 57 D 30		246-086-001-007C	HLWP	T1: 3b

330 d (150 kW | 3.0 Liter)

03.03 → 02.05	M57N306D2		246-082-008-025G	SWP-M-C	T1: 3
03.03 → 02.05	M57N306D2		246-086-001-007C	HLWP	T1: 3b

330 xd (150 kW | 3.0 Liter)

03.03 → 02.05	M57N306D2		246-082-008-025G	SWP-M-C	T1: 3
03.03 → 02.05	M57N306D2		246-086-001-007C	HLWP	T1: 3b

3 Compact (E46)**316 ti (85 kW | 1.8 Liter)**

06.01 → 02.05	N 42 B 18		246-082-008-025G	SWP-M-C	T1: 3
06.01 → 02.05	N 42 B 18		246-086-001-007C	HLWP	T1: 3b

318 ti (105 kW | 2.0 Liter)

09.01 → 02.05	N 42 B 20		246-082-008-025G	SWP-M-C	T1: 3
09.01 → 02.05	N 42 B 20		246-086-001-007C	HLWP	T1: 3b

325 ti (141 kW | 2.5 Liter)

06.01 → 02.05	M54256S5		246-082-008-025G	SWP-M-C	T1: 3
06.01 → 02.05	M54256S5		246-086-001-007C	HLWP	T1: 3b

318 td (85 kW | 2.0 Liter)

03.03 → 02.05	M47N204D4		246-082-008-025G	SWP-M-C	T1: 3
03.03 → 02.05	M47N204D4		246-086-001-007C	HLWP	T1: 3b

320 td (110 kW | 2.0 Liter)

09.01 → 02.05	M47N204D4		246-082-008-025G	SWP-M-C	T1: 3
09.01 → 02.05	M47N204D4		246-086-001-007C	HLWP	T1: 3b





3 Coupe (E46)**316 Ci (77 kW | 1.6 Liter)**

04.00 →	M 43 B 16 (16 4 E3)		246-082-008-025G	SWP-M-C	T1: 3
04.00 →	M 43 B 16 (16 4 E3)		246-086-001-007C	HLWP	T1: 3b

316 Ci (85 kW | 1.6 Liter)

06.02 →	N45B16A		246-082-008-025G	SWP-M-C	T1: 3
06.02 →	N45B16A		246-086-001-007C	HLWP	T1: 3b



			VDO		
Datum	Motorcode	Fahrgestell Nr.	Artikel Nr.	Artikelbez.	Information

BMW**3 Coupe (E46)****318 Ci (87 kW | 1.9 Liter)**

11.99 → 09.01 M 43 B 19 246-082-008-025G SWP-M-C T1: 3

318 Ci (105 kW | 2.0 Liter)

09.01 → N 42 B 20 246-082-008-025G SWP-M-C T1: 3

09.01 → N 42 B 20 246-086-001-007C HLWP T1: 3b

320 Ci (110 kW | 2.0 Liter)

08.99 → 09.00 M 52 B (20 6 S4) 246-082-008-025G SWP-M-C T1: 3

08.99 → 09.00 M 52 B (20 6 S4) 246-086-001-007C HLWP T1: 3b

320 Ci (125 kW | 2.2 Liter)

09.00 → M54226S1 246-082-008-025G SWP-M-C T1: 3

09.00 → M54226S1 246-086-001-007C HLWP T1: 3b

323 Ci (125 kW | 2.5 Liter)

04.99 → 09.00 M 52 B 25 (Vanos) 246-082-008-025G SWP-M-C T1: 3

04.99 → 09.00 M 52 B 25 (Vanos) 246-086-001-007C HLWP T1: 3b

325 Ci (141 kW | 2.5 Liter)

09.00 → M54256S5 246-082-008-025G SWP-M-C T1: 3

09.00 → M54256S5 246-086-001-007C HLWP T1: 3b

328 Ci (142 kW | 2.8 Liter)

04.99 → 06.00 M 52 B 28 246-082-008-025G SWP-M-C T1: 3

04.99 → 06.00 M 52 B 28 246-086-001-007C HLWP T1: 3b

330 Ci (170 kW | 3.0 Liter)

06.00 → M54306S3 246-082-008-025G SWP-M-C T1: 3

06.00 → M54306S3 246-086-001-007C HLWP T1: 3b

M3 3.2 (252 kW | 3.2 Liter)

09.01 → S54326S4 246-082-008-025G SWP-M-C T1: 3

06.00 → S54326S4 246-086-001-007C HLWP T1: 3b

M3 CSL (265 kW | 3.2 Liter)

06.03 → S54N326S4 246-082-008-025G SWP-M-C T1: 3

06.03 → S54N326S4 246-086-001-007C HLWP T1: 3b

320 Cd (110 kW | 2.0 Liter)

11.03 → M47N204D4 246-082-008-025G SWP-M-C T1: 3

11.03 → M47N204D4 246-086-001-007C HLWP T1: 3b

330 Cd (150 kW | 3.0 Liter)

03.03 → M57N306D2 246-082-008-025G SWP-M-C T1: 3

03.03 → M57N306D2 246-086-001-007C HLWP T1: 3b

3 Cabriolet (E46)**318 Ci (105 kW | 2.0 Liter)**

09.01 → N 42 B 20 246-082-008-025G SWP-M-C T1: 3





320 Ci (125 kW | 2.2 Liter)

09.00 → M 54 B 22 / M54226S1 246-082-008-025G SWP-M-C T1: 3

323 Ci (125 kW | 2.5 Liter)

04.00 → 09.00 M 52 B 25 (Vanos) 246-082-008-025G SWP-M-C T1: 3



			VDO		
Datum	Motorcode	Fahrgestell Nr.	Artikel Nr.	Artikelbez.	Information





BMW**3 Cabriolet (E46)**

325 Ci (141 kW 2.5 Liter)					
09.00 →	M54256S5		246-082-008-025G	SWP-M-C	T1: 3
330 Ci (170 kW 3.0 Liter)					
06.00 →	M54306S3		246-082-008-025G	SWP-M-C	T1: 3
M3 3.2 (252 kW 3.2 Liter)					
09.01 →	S54326S4		246-082-008-025G	SWP-M-C	T1: 3
320 Cd (110 kW 2.0 Liter)					
02.05 →	M47N204D4		246-082-008-025G	SWP-M-C	T1: 3

3 Touring (E46)

316 i (85 kW 1.6 Liter)					
06.02 →	N45B16A		246-082-008-025G	SWP-M-C	T1: 3
06.02 →	N45B16A		246-086-001-007C	HLWP	T1: 3b
316 i (85 kW 1.8 Liter)					
03.02 →	N 42 B 18		246-082-008-025G	SWP-M-C	T1: 3
318 i (87 kW 1.9 Liter)					
10.99 → 09.01	M 43 B 19		246-082-008-025G	SWP-M-C	T1: 3
318 i (105 kW 2.0 Liter)					
09.01 →	N 42 B 20		246-082-008-025G	SWP-M-C	T1: 3
320 i (110 kW 2.0 Liter)					
10.99 → 09.00	M 52 B (20 6 S3) Vanos		246-082-008-025G	SWP-M-C	T1: 3
320 i (125 kW 2.2 Liter)					
09.00 →	M54226S1		246-082-008-025G	SWP-M-C	T1: 3
325 i (141 kW 2.5 Liter)					
09.00 →	M54256S5		246-082-008-025G	SWP-M-C	T1: 3
325 xi (141 kW 2.5 Liter)					
09.00 →	M54256S5		246-082-008-025G	SWP-M-C	T1: 3
328 i (142 kW 2.8 Liter)					
10.99 → 06.00	M 52 B 28		246-082-008-025G	SWP-M-C	T1: 3
330 i (170 kW 3.0 Liter)					
08.00 →	M54306S3		246-082-008-025G	SWP-M-C	T1: 3
330 xi (170 kW 3.0 Liter)					
08.00 →	M54306S3		246-082-008-025G	SWP-M-C	T1: 3
318 d (85 kW 2.0 Liter)					
03.02 →	M47204D1		246-082-008-025G	SWP-M-C	T1: 3
318 d (85 kW 2.0 Liter)					
03.03 →	M47N204D4		246-082-008-025G	SWP-M-C	T1: 3
03.03 →	M47N204D4		246-086-001-007C	HLWP	T1: 3b
320 d (100 kW 2.0 Liter)					
03.00 → 09.01	M 47 D 20 / M47204D1		246-082-008-025G	SWP-M-C	T1: 3
320 d (110 kW 2.0 Liter)					
09.01 →	M47N204D4		246-082-008-025G	SWP-M-C	T1: 3
330 d (135 kW 3.0 Liter)					
10.99 →	M 57 D 30		246-082-008-025G	SWP-M-C	T1: 3



			VDO		
Datum	Motorcode	Fahrgestell Nr.	Artikel Nr.	Artikelbez.	Information

BMW**3 Touring (E46)****330 xd (135 kW | 3.0 Liter)**

06.00 →	M 57 D 30		246-082-008-025G	SWP-M-C	T1: 3
---------	-----------	--	------------------	---------	-------

330 d (150 kW | 3.0 Liter)

03.03 →	M57N306D2		246-082-008-025G	SWP-M-C	T1: 3
---------	-----------	--	------------------	---------	-------

03.03 →	M57N306D2		246-086-001-007C	HLWP	T1: 3b
---------	-----------	--	------------------	------	--------

330 xd (150 kW | 3.0 Liter)

03.03 →	M57N306D2		246-082-008-025G	SWP-M-C	T1: 3
---------	-----------	--	------------------	---------	-------

03.03 →	M57N306D2		246-086-001-007C	HLWP	T1: 3b
---------	-----------	--	------------------	------	--------

3 (E90)**320i (110 kW | 2.0 Liter)**

01.05 →	N46B20A / N46B20C		246-082-008-025G	SWP-M-C	T1: 3
---------	-------------------	--	------------------	---------	-------

325i (160 kW | 2.5 Liter)

01.05 →	N52B25A		246-082-008-025G	SWP-M-C	T1: 3
---------	---------	--	------------------	---------	-------

330i (190 kW | 3.0 Liter)

01.05 →	N52B30A		246-082-008-025G	SWP-M-C	T1: 3
---------	---------	--	------------------	---------	-------

320d (120 kW | 2.0 Liter)

01.05 →	M47N204D4		246-082-008-025G	SWP-M-C	T1: 3
---------	-----------	--	------------------	---------	-------

5 (E12)**518 (66 kW | 1.8 Liter)**

07.74 → 05.81	M 10 B 18 / M 10 B 18 (2B4) / M 10 B 18 (32/32 DIDTA)		246-075-023-004C	SWP-M-G	T1: 1; T2: D
---------------	----------------------------------------------------------	--	------------------	---------	--------------

520 (85 kW | 2.0 Liter)

08.72 → 08.77	M 10 B 20 (Strombergvergaser)		246-075-023-004C	SWP-M-G	T1: 1; T2: D
---------------	-------------------------------	--	------------------	---------	--------------

520/6 (90 kW | 2.0 Liter)

09.77 → 05.81	M 20 B 20		246-075-023-004C	SWP-M-G	T1: 1; T2: D
---------------	-----------	--	------------------	---------	--------------

520 i (92 kW | 2.0 Liter)

08.76 → 05.77	M 10 B 20 (K-Jetronic)		246-075-023-004C	SWP-M-G	T1: 1; T2: D
---------------	------------------------	--	------------------	---------	--------------

520 i (96 kW | 2.0 Liter)

10.72 → 10.75	M 10 B 20 / M 10 B 20 (Schäfer-Inj.)		246-075-023-004C	SWP-M-G	T1: 1; T2: D
---------------	-----------------------------------------	--	------------------	---------	--------------

525 (107 kW | 2.5 Liter)

08.73 → 10.76	M 30 B 25 (32/40 INAT)		246-075-023-004C	SWP-M-G	T1: 1; T2: D
---------------	------------------------	--	------------------	---------	--------------

525 (110 kW | 2.5 Liter)

08.76 → 05.81	M 30 B 25 (4A1)		246-075-023-004C	SWP-M-G	T1: 1; T2: D
---------------	-----------------	--	------------------	---------	--------------

528 (121 kW | 2.8 Liter)

01.75 → 07.77	M 30 B 28 (32/40 INAT)		246-075-023-004C	SWP-M-G	T1: 1; T2: D
---------------	------------------------	--	------------------	---------	--------------

528 i (130 kW | 2.8 Liter)

04.77 → 05.81	M 30 B 28 (L-Jetronic)		246-075-023-004C	SWP-M-G	T1: 1; T2: D
---------------	------------------------	--	------------------	---------	--------------

M 535 i (160 kW | 3.4 Liter)

06.80 → 05.81	M 30 B 35 (Motronic,9.3:1)		246-075-023-004C	SWP-M-G	T1: 1; T2: D
---------------	----------------------------	--	------------------	---------	--------------



			VDO		
Datum	Motorcode	Fahrgestell Nr.	Artikel Nr.	Artikelbez.	Information

BMW**5 (E34)****520 i (95 kW | 2.0 Liter)**

01.88 → 08.91	M 20 B 20 (Motronic,Kat.)		246-069-059-001Z	N	
01.88 → 08.91	M 20 B 20 (Motronic,Kat.)		246-080-013-001Z	N-H	
09.90 → 08.91	M 20 B 20 (Motronic,Kat.)		246-080-013-003Z	N-H	

520 i 24V (110 kW | 2.0 Liter)

09.89 → 09.95	M 50 B (20 6 S1) / M 50 B (20 6 S2) Vanos		246-069-059-001Z	N	
09.89 → 09.95	M 50 B (20 6 S1) / M 50 B (20 6 S2) Vanos		246-080-013-001Z	N-H	
09.90 → 09.95	M 50 B (20 6 S1) / M 50 B (20 6 S2) Vanos		246-080-013-003Z	N-H	

525 i (125 kW | 2.5 Liter)

01.88 → 08.91	M 20 B 25 (Kat.)		246-069-059-001Z	N	
09.90 → 08.91	M 20 B 25 (Kat.)		246-080-013-003Z	N-H	

525 i 24V (141 kW | 2.5 Liter)

09.89 → 09.95	M 50 B 25 / M 52 B 25 (Vanos)		246-069-059-001Z	N	
09.90 → 09.95	M 50 B 25 / M 52 B 25 (Vanos)		246-080-013-003Z	N-H	

525 i X 24V (141 kW | 2.5 Liter)

10.91 → 09.95	M 52 B 25 (Vanos)		246-069-059-001Z	N	
10.91 → 09.95	M 52 B 25 (Vanos)		246-080-013-003Z	N-H	

530 i (138 kW | 3.0 Liter)

01.88 → 08.91	M 30 B 30 (Kat.)		246-069-059-001Z	N	
---------------	------------------	--	------------------	---	--

530 i V8 (160 kW | 3.0 Liter)

09.92 → 09.95	M 60 B 30		246-069-059-001Z	N	
---------------	-----------	--	------------------	---	--

535 i (155 kW | 3.4 Liter)

01.88 → 09.95	M 30 B 35 (Motronic,9:1,Kat.)		246-069-059-001Z	N	
---------------	-------------------------------	--	------------------	---	--

540 i V8 (210 kW | 4.0 Liter)

09.92 → 09.95	M 60 B 40		246-069-059-001Z	N	
---------------	-----------	--	------------------	---	--

M5 3.6 (232 kW | 3.6 Liter)

10.88 → 05.92	S 38 B 36		246-069-059-001Z	N	
---------------	-----------	--	------------------	---	--

M5 3.6 KAT (232 kW | 3.6 Liter)

10.88 → 05.92	S 38 B 36 (Kat)		246-069-059-001Z	N	
---------------	-----------------	--	------------------	---	--

M5 3.8 (250 kW | 3.8 Liter)

03.92 → 09.95	S 38 B 38		246-069-059-001Z	N	
---------------	-----------	--	------------------	---	--

524 td (85 kW | 2.4 Liter)

03.88 → 09.95	M 21 D 24 / M 21 D 24 WA		246-069-059-001Z	N	
---------------	--------------------------	--	------------------	---	--

525 td (85 kW | 2.5 Liter)

04.93 → 09.95	M 51 D 25		246-069-059-001Z	N	
---------------	-----------	--	------------------	---	--

525 tds (105 kW | 2.5 Liter)

09.91 → 09.95	M 51 D 25 (Inter.)		246-069-059-001Z	N	
---------------	--------------------	--	------------------	---	--



			VDO		
Datum	Motorcode	Fahrgestell Nr.	Artikel Nr.	Artikelbez.	Information

BMW**5 (E39)****520 i (100 kW | 2.0 Liter)**

04.99 → 06.03			246-082-008-025G	SWP-M-C	T1: 3
04.99 → 06.03			246-086-001-007C	HLWP	T1: 3b

520 i (110 kW | 2.0 Liter)

09.97 → 09.00	M 52 B (20 6 S3) Vanos / M 52 B (20 6 S4)		246-082-008-025G	SWP-M-C	T1: 3
09.97 → 09.00	M 52 B (20 6 S3) Vanos / M 52 B (20 6 S4)		246-086-001-007C	HLWP	T1: 3b

520 i (125 kW | 2.2 Liter)

09.00 → 06.03	M 54 B 22		246-082-008-025G	SWP-M-C	T1: 3
09.00 → 06.03	M 54 B 22		246-086-001-007C	HLWP	T1: 3b

523 i (125 kW | 2.5 Liter)

09.97 → 09.00	M 52 B 25 (Vanos)		246-082-008-025G	SWP-M-C	T1: 3
09.97 → 09.00	M 52 B 25 (Vanos)		246-086-001-007C	HLWP	T1: 3b

525 i (141 kW | 2.5 Liter)

09.00 → 06.03	M54256S5		246-082-008-025G	SWP-M-C	T1: 3
09.00 → 06.03	M54256S5		246-086-001-007C	HLWP	T1: 3b

528 i (142 kW | 2.8 Liter)

09.97 → 09.00	M 52 B 28		246-082-008-025G	SWP-M-C	T1: 3
09.97 → 09.00	M 52 B 28		246-086-001-007C	HLWP	T1: 3b

530 i (170 kW | 3.0 Liter)

09.00 → 06.03	M54306S3		246-082-008-025G	SWP-M-C	T1: 3
09.00 → 06.03	M54306S3		246-086-001-007C	HLWP	T1: 3b

535 i (173 kW | 3.5 Liter)

09.97 → 03.99	M 62 B (35 8 S1)		246-082-008-025G	SWP-M-C	T1: 3
09.97 → 03.99	M 62 B (35 8 S1)		246-086-001-007C	HLWP	T1: 3b

535 i (180 kW | 3.5 Liter)

04.99 → 06.03	M 62 B (35 8 S2)		246-082-008-025G	SWP-M-C	T1: 3
04.99 → 06.03	M 62 B (35 8 S2)		246-086-001-007C	HLWP	T1: 3b

540 i (210 kW | 4.4 Liter)

09.97 → 06.03	M 62 B 44		246-082-008-025G	SWP-M-C	T1: 3
09.97 → 06.03	M 62 B 44		246-086-001-007C	HLWP	T1: 3b

M5 (294 kW | 4.9 Liter)

10.98 → 06.03	S 38 B 49		246-082-008-025G	SWP-M-C	T1: 3
10.98 → 06.03	S 38 B 49		246-086-001-007C	HLWP	T1: 3b

520 d (100 kW | 2.0 Liter)

02.00 → 06.03	M 47 D 20 / M47204D1		246-082-008-025G	SWP-M-C	T1: 3
02.00 → 06.03	M 47 D 20 / M47204D1		246-086-001-007C	HLWP	T1: 3b





525 td (85 kW | 2.5 Liter)

09.97 → 06.03	M 51 D 25		246-082-008-025G	SWP-M-C	T1: 3
09.97 → 06.03	M 51 D 25		246-086-001-007C	HLWP	T1: 3b

525 d (120 kW | 2.5 Liter)

02.00 → 06.03	M57256D1		246-082-008-025G	SWP-M-C	T1: 3
02.00 → 06.03	M57256D1		246-086-001-007C	HLWP	T1: 3b



			VDO		
Datum	Motorcode	Fahrgestell Nr.	Artikel Nr.	Artikelbez.	Information

BMW**5 (E39)****525 tds (105 kW | 2.5 Liter)**

09.97 → 06.03	M 51 D 25 (Inter.)		246-082-008-025G	SWP-M-C	T1: 3
09.97 → 06.03	M 51 D 25 (Inter.)		246-086-001-007C	HLWP	T1: 3b

530 d (135 kW | 3.0 Liter)

08.98 → 09.00	M 57 D 30		246-082-008-025G	SWP-M-C	T1: 3
08.98 → 09.00	M 57 D 30		246-086-001-007C	HLWP	T1: 3b

530 d (142 kW | 3.0 Liter)

09.00 → 06.03	M 57 D 30		246-082-008-025G	SWP-M-C	T1: 3
09.00 → 06.03	M 57 D 30		246-086-001-007C	HLWP	T1: 3b

5 Touring (E39)**520 i (100 kW | 2.0 Liter)**

04.99 → 05.04			246-082-008-025G	SWP-M-C	T1: 3
04.99 → 05.04			246-086-001-007C	HLWP	T1: 3b

520 i (110 kW | 2.0 Liter)

09.97 → 09.00	M 52 B (20 6 S3) Vanos / M 52 B (20 6 S4)		246-082-008-025G	SWP-M-C	T1: 3
01.97 → 09.00	M 52 B (20 6 S3) Vanos / M 52 B (20 6 S4)		246-086-001-007C	HLWP	T1: 3b

520 i (125 kW | 2.2 Liter)

09.00 → 05.04	M 54 B 22		246-082-008-025G	SWP-M-C	T1: 3
09.00 → 05.04	M 54 B 22		246-086-001-007C	HLWP	T1: 3b

523 i (125 kW | 2.5 Liter)

09.97 → 09.00	M 52 B 25 (Vanos)		246-082-008-025G	SWP-M-C	T1: 3
01.97 → 09.00	M 52 B 25 (Vanos)		246-086-001-007C	HLWP	T1: 3b

525 i (141 kW | 2.5 Liter)

09.00 → 05.04	M54256S5		246-082-008-025G	SWP-M-C	T1: 3
09.00 → 05.04	M54256S5		246-086-001-007C	HLWP	T1: 3b

528 i (142 kW | 2.8 Liter)

09.97 → 09.00	M 52 B 28		246-082-008-025G	SWP-M-C	T1: 3
01.97 → 09.00	M 52 B 28		246-086-001-007C	HLWP	T1: 3b

530 i (170 kW | 3.0 Liter)

09.00 → 05.04	M54306S3		246-082-008-025G	SWP-M-C	T1: 3
09.00 → 05.04	M54306S3		246-086-001-007C	HLWP	T1: 3b

540 i (210 kW | 4.4 Liter)

09.97 → 05.04	M 62 B 44		246-082-008-025G	SWP-M-C	T1: 3
01.97 → 05.04	M 62 B 44		246-086-001-007C	HLWP	T1: 3b

520 d (100 kW | 2.0 Liter)

02.00 → 09.03	M 47 D 20 / M47204D1		246-082-008-025G	SWP-M-C	T1: 3
02.00 → 09.03	M 47 D 20 / M47204D1		246-086-001-007C	HLWP	T1: 3b

525 d (120 kW | 2.5 Liter)

02.00 → 05.04	M57256D1		246-082-008-025G	SWP-M-C	T1: 3
02.00 → 05.04	M57256D1		246-086-001-007C	HLWP	T1: 3b



			VDO		
Datum	Motorcode	Fahrgestell Nr.	Artikel Nr.	Artikelbez.	Information

BMW**5 Touring (E39)****525 tds (105 kW | 2.5 Liter)**

03.97 → 05.04	M 51 D 25 (Inter.)		246-082-008-025G	SWP-M-C	T1: 3
03.97 → 05.04	M 51 D 25 (Inter.)		246-086-001-007C	HLWP	T1: 3b

530 d (135 kW | 3.0 Liter)

08.98 → 09.00	M 57 D 30		246-082-008-025G	SWP-M-C	T1: 3
08.98 → 09.00	M 57 D 30		246-086-001-007C	HLWP	T1: 3b

530 d (142 kW | 3.0 Liter)

09.00 → 05.04	M 57 D 30		246-082-008-025G	SWP-M-C	T1: 3
09.00 → 05.04	M 57 D 30		246-086-001-007C	HLWP	T1: 3b

5 (E60)**520i (125 kW | 2.2 Liter)**

07.03 → 09.03	M54226S1		246-082-008-025G	SWP-M-C	T1: 3
07.03 →	M54226S1		246-086-001-007C	HLWP	T1: 3b

523i (130 kW | 2.5 Liter)

07.05 →	N52B25A		246-086-001-007C	HLWP	T1: 3b
---------	---------	--	------------------	------	--------

525i (141 kW | 2.5 Liter)

09.03 → 09.03	M54256S5		246-082-008-025G	SWP-M-C	T1: 3
09.03 →	M54256S5		246-086-001-007C	HLWP	T1: 3b

525i (160 kW | 2.5 Liter)

07.05 →	N52B25A		246-086-001-007C	HLWP	T1: 3b
---------	---------	--	------------------	------	--------

530i (170 kW | 3.0 Liter)

07.03 → 09.03	M54306S3		246-082-008-025G	SWP-M-C	T1: 3
07.03 →	M54306S3		246-086-001-007C	HLWP	T1: 3b

530i (190 kW | 3.0 Liter)

07.05 →	N52B30A		246-086-001-007C	HLWP	T1: 3b
---------	---------	--	------------------	------	--------

545i (245 kW | 4.4 Liter)

09.03 → 09.03	N 62 B 44		246-082-008-025G	SWP-M-C	T1: 3
09.03 →	N 62 B 44		246-086-001-007C	HLWP	T1: 3b

M5 (373 kW | 5.0 Liter)

09.04 →	S85B50A		246-086-001-007C	HLWP	T1: 3b
---------	---------	--	------------------	------	--------

525d (130 kW | 2.5 Liter)

06.04 →	M57N256D4		246-086-001-007C	HLWP	T1: 3b
---------	-----------	--	------------------	------	--------

530d (160 kW | 3.0 Liter)

07.03 → 09.03	N57306D2		246-082-008-025G	SWP-M-C	T1: 3
07.03 →	N57306D2		246-086-001-007C	HLWP	T1: 3b

530d (170 kW | 3.0 Liter)

07.03 → 09.03			246-082-008-025G	SWP-M-C	T1: 3
07.03 →			246-086-001-007C	HLWP	T1: 3b



			VDO		
Datum	Motorcode	Fahrgestell Nr.	Artikel Nr.	Artikelbez.	Information

BMW**5 Touring (E61)**

523i (130 kW 2.5 Liter)					
07.05 →	N52B25A		246-082-008-025G	SWP-M-C	T1: 3
07.05 →	N52B25A		246-086-001-007C	HLWP	T1: 3b
525i (141 kW 2.5 Liter)					
06.04 →	M54256S5		246-082-008-025G	SWP-M-C	T1: 3
06.04 →	M54256S5		246-086-001-007C	HLWP	T1: 3b
525i (160 kW 2.5 Liter)					
07.05 →	N52B25A		246-082-008-025G	SWP-M-C	T1: 3
07.05 →	N52B25A		246-086-001-007C	HLWP	T1: 3b
530i (170 kW 3.0 Liter)					
06.04 →	M54306S3		246-082-008-025G	SWP-M-C	T1: 3
06.04 →	M54306S3		246-086-001-007C	HLWP	T1: 3b
530i (190 kW 3.0 Liter)					
07.05 →	N52B30A		246-082-008-025G	SWP-M-C	T1: 3
07.05 →	N52B30A		246-086-001-007C	HLWP	T1: 3b
545i (245 kW 4.4 Liter)					
06.04 →	N 62 B 44		246-082-008-025G	SWP-M-C	T1: 3
06.04 →	N 62 B 44		246-086-001-007C	HLWP	T1: 3b
525d (130 kW 2.5 Liter)					
06.04 →	M57N256D4		246-082-008-025G	SWP-M-C	T1: 3
06.04 →	M57N256D4		246-086-001-007C	HLWP	T1: 3b
530d (160 kW 3.0 Liter)					
06.04 →	N57306D2		246-082-008-025G	SWP-M-C	T1: 3
06.04 →	N57306D2		246-086-001-007C	HLWP	T1: 3b
530d (170 kW 3.0 Liter)					
07.05 →			246-082-008-025G	SWP-M-C	T1: 3
07.05 →			246-086-001-007C	HLWP	T1: 3b
535d (200 kW 3.0 Liter)					
09.04 →	M57306D4		246-082-008-025G	SWP-M-C	T1: 3
09.04 →	M57306D4		246-086-001-007C	HLWP	T1: 3b





6 (E24)

628 CSi (135 kW 2.8 Liter)					
09.79 → 08.87	M 30 B 28 (L-Jetronic)		246-080-013-001Z	N-H	
M 635 CSi (191 kW 3.5 Liter)					
10.86 → 10.88	S 38 B 35 (Kat)		246-080-013-001Z	N-H	
M 635 CSi (211 kW 3.4 Liter)					
03.84 → 05.89	S 38 B 35		246-080-013-001Z	N-H	

6 (E63)

630i (190 kW 3.0 Liter)					
09.04 →	N52B30A		246-086-001-007C	HLWP	T1: 3b



			VDO		
Datum	Motorcode	Fahrgestell Nr.	Artikel Nr.	Artikelbez.	Information

BMW**6 (E63)****645Ci (245 kW | 4.4 Liter)**

01.04 →	N 62 B 44 / N62B44A		246-086-001-007C	HLWP	T1: 3b
---------	---------------------	--	------------------	------	--------

650i (270 kW | 4.8 Liter)

07.05 →			246-086-001-007C	HLWP	T1: 3b
---------	--	--	------------------	------	--------

7 (E23)**728 (125 kW | 2.8 Liter)**

05.77 → 08.79	M 30 B 28 (4A1)		246-075-042-001C	SWP-M-G	T1: 1
---------------	-----------------	--	------------------	---------	-------

728 i (135 kW | 2.8 Liter)

07.78 → 08.86	M 30 B 28 (L-Jetronic)		246-075-042-001C	SWP-M-G	T1: 1
---------------	------------------------	--	------------------	---------	-------

730 (135 kW | 3.0 Liter)

05.77 → 08.79	M 30 B 30 (4A1)		246-075-042-001C	SWP-M-G	T1: 1
---------------	-----------------	--	------------------	---------	-------

732 i/733 i (145 kW | 3.2 Liter)

05.77 → 08.86	M 30 B 32 / M 30 B 32 (L-Jetronic,9:1) / M 30 B 32 (Motronic,10:1)		246-075-042-001C	SWP-M-G	T1: 1
---------------	--------------------------------------------------------------------------	--	------------------	---------	-------

735 i (136 kW | 3.4 Liter)

01.85 → 08.86	M 30 B 35 (Motronic,8:1,Kat.)		246-075-042-001C	SWP-M-G	T1: 1
---------------	-------------------------------	--	------------------	---------	-------

735 i (141 kW | 3.4 Liter)

04.85 → 08.86	M 30 B 35 (Motronic)		246-075-042-001C	SWP-M-G	T1: 1
---------------	----------------------	--	------------------	---------	-------

735 i (160 kW | 3.4 Liter)

09.79 → 08.86	M 30 B 35 (Motronic,10:1) / M 30 B 35 (Motronic,9.3:1)		246-075-042-001C	SWP-M-G	T1: 1
---------------	-----------------------------------------------------------	--	------------------	---------	-------

745 i (185 kW | 3.2 Liter)

04.80 → 04.83	M 30 B 32 / M 30 B 32 (Turbo,7.5:1) / M 30 B 32 (Turbo,8:1)		246-075-042-001C	SWP-M-G	T1: 1
---------------	-------------------------------------------------------------------	--	------------------	---------	-------

745 i (185 kW | 3.4 Liter)

05.83 → 08.86	M 30 B 35		246-075-042-001C	SWP-M-G	T1: 1
---------------	-----------	--	------------------	---------	-------

7 (E32)**730 i,iL (138 kW | 3.0 Liter)**

12.86 → 09.94	M 30 B 30 (Kat.)		246-069-059-001Z	N	
09.90 → 09.94	M 30 B 30 (Kat.)		246-080-013-003Z	N-H	

730 i,iL (145 kW | 3.0 Liter)

12.86 → 09.94	M 30 B 30		246-069-059-001Z	N	
09.90 → 09.94	M 30 B 30		246-080-013-003Z	N-H	

730 i,iL V8 (160 kW | 3.0 Liter)

04.92 → 09.94	M 60 B 30		246-069-059-001Z	N	
04.92 → 09.94	M 60 B 30		246-080-013-003Z	N-H	



			VDO		
Datum	Motorcode	Fahrgestell Nr.	Artikel Nr.	Artikelbez.	Information

BMW**7 (E32)****735 i,iL (155 kW | 3.4 Liter)**

09.86 → 09.92	M 30 B 35 (Motronic,9:1,Kat.))		246-069-059-001Z	N	
09.86 → 09.92	M 30 B 35 (Motronic,9:1,Kat.))		246-080-013-001Z	N-H	
09.90 → 09.92	M 30 B 35 (Motronic,9:1,Kat.))		246-080-013-003Z	N-H	

735 i,iL (162 kW | 3.4 Liter)

09.86 → 12.87	M 30 B 35 (Motronic,9.2:1)		246-069-059-001Z	N	
09.86 → 12.87	M 30 B 35 (Motronic,9.2:1)		246-080-013-001Z	N-H	

740 i,iL V8 (210 kW | 4.0 Liter)

04.92 → 09.94	M 60 B 40		246-069-059-001Z	N	
04.92 → 09.94	M 60 B 40		246-080-013-003Z	N-H	

750 i,iL V12 (220 kW | 5.0 Liter)

09.87 → 09.94	M 70 B 50		246-069-059-001Z	N	
09.87 → 09.94	M 70 B 50		246-080-013-001Z	N-H	
09.90 → 09.94	M 70 B 50		246-080-013-003Z	N-H	

7 (E38)**728 i,iL (142 kW | 2.8 Liter)**

09.97 → 11.01	M 52 B 28		246-082-008-025G	SWP-M-C	T1: 3
---------------	-----------	--	------------------	---------	-------

730 i,iL (155 kW | 3.0 Liter)

09.97 → 11.01	M 60 B 30		246-082-008-025G	SWP-M-C	T1: 3
09.97 → 11.01	M 60 B 30		246-086-001-007C	HLWP	T1: 3b

730 i,iL (160 kW | 3.0 Liter)

09.97 → 11.01	M 60 B 30		246-082-008-025G	SWP-M-C	T1: 3
09.97 → 11.01	M 60 B 30		246-086-001-007C	HLWP	T1: 3b

735 i,iL (173 kW | 3.5 Liter)

09.97 → 11.01	M 62 B (35 8 S1)		246-082-008-025G	SWP-M-C	T1: 3
09.97 → 11.01	M 62 B (35 8 S1)		246-086-001-007C	HLWP	T1: 3b

740 i,iL (210 kW | 4.0 Liter)

09.97 → 11.01	M 60 B 40		246-082-008-025G	SWP-M-C	T1: 3
09.97 → 11.01	M 60 B 40		246-086-001-007C	HLWP	T1: 3b

740 i,iL (210 kW | 4.4 Liter)

09.97 → 11.01	M 62 B 44		246-082-008-025G	SWP-M-C	T1: 3
09.97 → 11.01	M 62 B 44		246-086-001-007C	HLWP	T1: 3b

750 i,iL (240 kW | 5.4 Liter)

09.97 → 11.01	M 73 B 54		246-082-008-025G	SWP-M-C	T1: 3
09.97 → 11.01	M 73 B 54		246-086-001-007C	HLWP	T1: 3b

725 tds (105 kW | 2.5 Liter)

09.97 → 11.01	M 51 D 25 (Inter.)		246-082-008-025G	SWP-M-C	T1: 3
---------------	--------------------	--	------------------	---------	-------

730 d (135 kW | 3.0 Liter)

08.98 → 04.00	M 57 D 30		246-086-001-007C	HLWP	T1: 3b
---------------	-----------	--	------------------	------	--------



			VDO		
Datum	Motorcode	Fahrgestell Nr.	Artikel Nr.	Artikelbez.	Information

BMW**7 (E38)****730 d (142 kW | 3.0 Liter)**

04.00 → 11.01	M57306D1		246-086-001-007C	HLWP	T1: 3b
---------------	----------	--	------------------	------	--------

740 d (180 kW | 3.9 Liter)

05.99 → 11.01	M 67 D 39		246-086-001-007C	HLWP	T1: 3b
---------------	-----------	--	------------------	------	--------

7 (E65, E66)**730 i,Li (170 kW | 3.0 Liter)**

03.03 → 09.03	M54306S3		246-082-008-025G	SWP-M-C	T1: 3
---------------	----------	--	------------------	---------	-------

03.03 →	M54306S3		246-086-001-007C	HLWP	T1: 3b
---------	----------	--	------------------	------	--------

735 i,Li (200 kW | 3.6 Liter)

11.01 →	N 62 B 36		246-082-008-025G	SWP-M-C	T1: 3
---------	-----------	--	------------------	---------	-------

11.01 →	N 62 B 36		246-086-001-007C	HLWP	T1: 3b
---------	-----------	--	------------------	------	--------

740 i,Li (225 kW | 4.0 Liter)

07.05 →	N62B40A		246-086-001-007C	HLWP	T1: 3b
---------	---------	--	------------------	------	--------

745 i,Li (245 kW | 4.4 Liter)

11.01 →	N 62 B 44		246-082-008-025G	SWP-M-C	T1: 3
---------	-----------	--	------------------	---------	-------

11.01 →	N 62 B 44		246-086-001-007C	HLWP	T1: 3b
---------	-----------	--	------------------	------	--------

750 i,Li (270 kW | 4.8 Liter)

07.05 →	N62B48B		246-086-001-007C	HLWP	T1: 3b
---------	---------	--	------------------	------	--------

760 i,Li (327 kW | 6.0 Liter)

01.03 →	N 73 B 60		246-086-001-007C	HLWP	T1: 3b
---------	-----------	--	------------------	------	--------

730 d (160 kW | 3.0 Liter)

10.02 →	N57306D2		246-086-001-007C	HLWP	T1: 3b
---------	----------	--	------------------	------	--------

740 d (190 kW | 3.9 Liter)

10.02 →	N67398D1		246-086-001-007C	HLWP	T1: 3b
---------	----------	--	------------------	------	--------

745 d (242 kW | 4.4 Liter)

07.05 →			246-086-001-007C	HLWP	T1: 3b
---------	--	--	------------------	------	--------

X3 (E83)**2.0 i (110 kW | 2.0 Liter)**

07.05 →			246-082-008-025G	SWP-M-C	T1: 3
---------	--	--	------------------	---------	-------

2.5 i (141 kW | 2.5 Liter)

01.04 →	M54256S5		246-082-008-025G	SWP-M-C	T1: 3
---------	----------	--	------------------	---------	-------

01.04 →	M54256S5		246-086-001-007C	HLWP	T1: 3b
---------	----------	--	------------------	------	--------

3.0 i (170 kW | 3.0 Liter)

01.04 →	M54306S3		246-082-008-025G	SWP-M-C	T1: 3
---------	----------	--	------------------	---------	-------

01.04 →	M54306S3		246-086-001-007C	HLWP	T1: 3b
---------	----------	--	------------------	------	--------

2.0 d (110 kW | 2.0 Liter)

10.04 →	M47N204D4		246-082-008-025G	SWP-M-C	T1: 3
---------	-----------	--	------------------	---------	-------





10.04 →	M47N204D4		246-086-001-007C	HLWP	T1: 3b
---------	-----------	--	------------------	------	--------

3.0 d (150 kW | 3.0 Liter)

01.04 →	M54N306D2		246-082-008-025G	SWP-M-C	T1: 3
---------	-----------	--	------------------	---------	-------

01.04 →	M54N306D2		246-086-001-007C	HLWP	T1: 3b
---------	-----------	--	------------------	------	--------



			VDO		
Datum	Motorcode	Fahrgestell Nr.	Artikel Nr.	Artikelbez.	Information

BMW**X3 (E83)****3.0 d (160 kW | 3.0 Liter)**

01.04 →			246-082-008-025G	SWP-M-C	T1: 3
01.04 →			246-086-001-007C	HLWP	T1: 3b

X5 (E53)**3.0 i (163 kW | 3.0 Liter)**

05.00 →	M54306S3		246-082-008-025G	SWP-M-C	T1: 3
05.00 →	M54306S3		246-086-001-007C	HLWP	T1: 3b

3.0 i (170 kW | 3.0 Liter)

05.00 →	M54306S3		246-082-008-025G	SWP-M-C	T1: 3
---------	----------	--	------------------	---------	-------

4.4 i (210 kW | 4.4 Liter)

05.00 →	M 62 B 44		246-082-008-025G	SWP-M-C	T1: 3
05.00 →	M 62 B 44		246-086-001-007C	HLWP	T1: 3b

4.4 i (235 kW | 4.4 Liter)

12.03 →	N62B44A		246-082-008-025G	SWP-M-C	T1: 3
---------	---------	--	------------------	---------	-------

4.6 is (255 kW | 4.6 Liter)

02.02 →	M67468S1		246-086-001-007C	HLWP	T1: 3b
---------	----------	--	------------------	------	--------

4.8 is (265 kW | 4.8 Liter)

04.04 →	N62B48A		246-082-008-025G	SWP-M-C	T1: 3
---------	---------	--	------------------	---------	-------

3.0 d (135 kW | 3.0 Liter)

05.01 →	M57306D1		246-086-001-007C	HLWP	T1: 3b
---------	----------	--	------------------	------	--------

3.0 d (160 kW | 3.0 Liter)

12.03 →	M57N306D4		246-082-008-025G	SWP-M-C	T1: 3
---------	-----------	--	------------------	---------	-------

Z3**1.8 (85 kW | 1.8 Liter)**

10.95 → 10.98	M 43 B 18		246-080-013-003Z	N-H	
11.97 → 08.98	M 43 B 18		246-082-008-025G	SWP-M-C	T1: 3

1.9 (85 kW | 1.9 Liter)

01.99 →	M43194E1		246-080-013-003Z	N-H	
01.99 →	M43194E1		246-082-008-025G	SWP-M-C	T1: 3
06.99 →	M43194E1		246-082-008-025G	SWP-M-C	T1: 3

1.9 (87 kW | 1.9 Liter)

07.98 →	M 43 B 19 / M43194E1		246-080-013-003Z	N-H	
09.98 →	M 43 B 19 / M43194E1		246-082-008-025G	SWP-M-C	T1: 3





1.9 (103 kW | 1.9 Liter)

10.95 → 03.99	M 44 B 19		246-080-013-003Z	N-H	
11.97 → 03.99	M 44 B 19		246-082-008-025G	SWP-M-C	T1: 3

2.0 (110 kW | 2.0 Liter)

04.99 →	M 52 B (20 6 S3) Vanos		246-080-013-003Z	N-H	
04.99 →	M 52 B (20 6 S3) Vanos		246-082-008-025G	SWP-M-C	T1: 3



			VDO		
Datum	Motorcode	Fahrgestell Nr.	Artikel Nr.	Artikelbez.	Information

BMW**Z3****2.2 (125 kW | 2.2 Liter)**

08.00 →	M 54 B 22 / M54226S1		246-080-013-003Z	N-H	
08.00 →	M 54 B 22 / M54226S1		246-082-008-025G	SWP-M-C	T1: 3

2.8 (141 kW | 2.8 Liter)

04.97 → 06.00	M 52 B 28		246-080-013-003Z	N-H	
11.97 → 06.00	M 52 B 28		246-082-008-025G	SWP-M-C	T1: 3

3.0 (170 kW | 3.0 Liter)

06.00 →	M54306S3		246-080-013-003Z	N-H	
06.00 →	M54306S3		246-082-008-025G	SWP-M-C	T1: 3

M 3.2 (236 kW | 3.2 Liter)

03.97 → 06.01	S 50 B 32		246-080-013-003Z	N-H	
11.97 → 06.01	S 50 B 32		246-082-008-025G	SWP-M-C	T1: 3

M 3.2 (239 kW | 3.2 Liter)

06.01 →	S 54 B 32 (32 6 S4)		246-080-013-003Z	N-H	
06.01 →	S 54 B 32 (32 6 S4)		246-082-008-025G	SWP-M-C	T1: 3

Z3 Coupe**2.8 (141 kW | 2.8 Liter)**

11.97 → 06.00	M 52 B 28		246-082-008-025G	SWP-M-C	T1: 3
07.98 → 06.00	M 52 B 28		246-083-002-022G	SWP-D-C	T1: 3

3.0 (170 kW | 3.0 Liter)

06.00 →	M54306S3		246-083-002-022G	SWP-D-C	T1: 3
---------	----------	--	------------------	---------	-------

M 3.2 (236 kW | 3.2 Liter)

02.98 → 06.01	S 50 B 32		246-082-008-025G	SWP-M-C	T1: 3
09.98 → 06.01	S 50 B 32		246-083-002-022G	SWP-D-C	T1: 3

M 3.2 (239 kW | 3.2 Liter)

06.01 →	S54326S4		246-083-002-022G	SWP-D-C	T1: 3
---------	----------	--	------------------	---------	-------

Z4 (E85)**2.0 i (110 kW | 2.0 Liter)**

04.05 →	N46B20A		246-082-008-025G	SWP-M-C	T1: 3
---------	---------	--	------------------	---------	-------

2.2 i (125 kW | 2.2 Liter)

10.03 →	M54226S1		246-082-008-025G	SWP-M-C	T1: 3
10.03 →	M54226S1		246-086-001-007C	HLWP	T1: 3b





2.5 i (141 kW | 2.5 Liter)

02.03 →	M54256S5		246-082-008-025G	SWP-M-C	T1: 3
02.03 →	M54256S5		246-086-001-007C	HLWP	T1: 3b

3.0 i (170 kW | 3.0 Liter)

02.03 →	M54306S3		246-082-008-025G	SWP-M-C	T1: 3
02.03 →	M54306S3		246-086-001-007C	HLWP	T1: 3b



			VDO		
Datum	Motorcode	Fahrgestell Nr.	Artikel Nr.	Artikelbez.	Information

BMW**Z8****4.9 (294 kW | 4.9 Liter)**

06.00 → 06.03 S 38 B 49

246-082-008-025G

SWP-M-C

T1: 3

CITROËN**AX (ZA-)****10 E (30 kW | 1.0 Liter)**

12.86 → 12.88 C3A

X10-729-002-007

SWP-M-C

T1: 11

10 (33 kW | 1.0 Liter)

07.86 → 12.98 CDY (TU9M)

X10-729-002-007

SWP-M-C

T1: 11

10 (37 kW | 1.0 Liter)

02.87 → 12.98 CDZ (TU9M)

X10-729-002-007

SWP-M-C

T1: 11

11 (40 kW | 1.1 Liter)

12.86 → 04.94 H1B

X10-729-002-007

SWP-M-C

T1: 11

11 KAT (40 kW | 1.1 Liter)

09.88 → 12.89 HAZ (TU1CP)

X10-729-002-007

SWP-M-C

T1: 11

11 (44 kW | 1.1 Liter)

09.86 → 12.97 H1B / HDZ (TU1M)

X10-729-002-007

SWP-M-C

T1: 11

1.3 Sport (70 kW | 1.3 Liter)

04.87 → 12.88 M4A

X10-729-002-007

SWP-M-C

T1: 11

14 (44 kW | 1.4 Liter)

12.86 → 12.88 KAY (TU3CP)

X10-729-002-007

SWP-M-C

T1: 11

14 (49 kW | 1.4 Liter)

06.88 → 12.89 K1F

X10-729-002-007

SWP-M-C

T1: 11

14 (55 kW | 1.4 Liter)04.87 → 04.97 KDX (TU3M/Z) / KDY (TU3FM)
/ KDY (TU3M) / KDZ (TU3M/Z)

X10-729-002-007

SWP-M-C

T1: 11

14 4x4 (55 kW | 1.4 Liter)08.91 → 12.96 KDX (TU3M/Z) / KDY (TU3FM)
/ KDY (TU3M) / KDZ (TU3M/Z)

X10-729-002-007

SWP-M-C

T1: 11

14 (62 kW | 1.4 Liter)

01.88 → 12.92 K2A / K2B

X10-729-002-007

SWP-M-C

T1: 11

1.4 GTi (66 kW | 1.4 Liter)

08.91 → 12.96 KFY (TU3FJ2)

X10-729-002-007

SWP-M-C

T1: 11

1.4 GTi (69 kW | 1.4 Liter)

06.91 → 12.96 KFZ (TU3FJ2)

X10-729-002-007

SWP-M-C

T1: 11

1.4 GTi (74 kW | 1.4 Liter)

06.91 → 12.92 KFZ (TU3FJ2)

X10-729-002-007

SWP-M-C

T1: 11

14 D (37 kW | 1.4 Liter)

08.91 → 12.97 K9Y (TUD3Y)

X10-729-002-007

SWP-M-C

T1: 11



			VDO		
Datum	Motorcode	Fahrgestell Nr.	Artikel Nr.	Artikelbez.	Information

CITROËN

AX (ZA-_)

14 D (38 kW | 1.4 Liter)

09.88 → 06.92	K9A (TUD3)		X10-729-002-007	SWP-M-C	T1: 11
---------------	------------	--	-----------------	---------	--------

15 D (40 kW | 1.5 Liter)

08.94 → 12.97	VJY (TUD5)		X10-729-002-007	SWP-M-C	T1: 11
---------------	------------	--	-----------------	---------	--------

15 D (43 kW | 1.5 Liter)

08.94 → 12.97	VJZ (TUD5)		X10-729-002-007	SWP-M-C	T1: 11
---------------	------------	--	-----------------	---------	--------

BERLINGO Kasten (M_)

1.1 i (MAHDZ, MBHDZ) (44 kW | 1.1 Liter)

07.96 →	HDZ (TU1M)		X10-729-002-007	SWP-M-C	T1: 11
---------	------------	--	-----------------	---------	--------

1.4 i (MBKFX) (55 kW | 1.4 Liter)

07.96 →	KFW (TU3JP) / KFX (TU3JP)		X10-729-002-007	SWP-M-C	T1: 11
---------	---------------------------	--	-----------------	---------	--------

1.8 D (MBA9A, MCA9A) (43 kW | 1.8 Liter)

07.96 →	A9A (XUD7)		X10-729-002-007	SWP-M-C	T1: 11
---------	------------	--	-----------------	---------	--------

1.9 D (MBWJZ, MCWJZ) (51 kW | 1.9 Liter)

04.99 →	WJZ (DW8)		X10-729-002-007	SWP-M-C	T1: 11
---------	-----------	--	-----------------	---------	--------

1.9 D 4WD (51 kW | 1.9 Liter)

07.98 →	WJZ (DW8)		X10-729-002-007	SWP-M-C	T1: 11
---------	-----------	--	-----------------	---------	--------

1.9 D (51 kW | 1.9 Liter)

07.96 →	DJY (XUD9A)		X10-729-002-007	SWP-M-C	T1: 11
---------	-------------	--	-----------------	---------	--------

2.0 HDI 90 (MBRHY, MCRHY) (66 kW | 2.0 Liter)

12.99 →	RHY (DW10TD)		X10-729-002-007	SWP-M-C	T1: 11
---------	--------------	--	-----------------	---------	--------

JUMPY (U6U)

1.6 (58 kW | 1.6 Liter)

10.95 →	1580 SPI / 220 A2.000		X10-729-002-007	SWP-M-C	T1: 11
---------	-----------------------	--	-----------------	---------	--------

2.0 (100 kW | 2.0 Liter)

04.00 →			X10-729-002-007	SWP-M-C	T1: 11
---------	--	--	-----------------	---------	--------

2.0 i 16V (102 kW | 2.0 Liter)

03.00 →			X10-729-002-007	SWP-M-C	T1: 11
---------	--	--	-----------------	---------	--------

1.9 D (51 kW | 1.9 Liter)

04.98 →	WJZ (DW8)		X10-729-002-007	SWP-M-C	T1: 11
---------	-----------	--	-----------------	---------	--------

1.9 D (51 kW | 1.9 Liter)

10.95 → 04.98	D9B (XUD9A/U)		X10-729-002-007	SWP-M-C	T1: 11
---------------	---------------	--	-----------------	---------	--------

1.9 TD (66 kW | 1.9 Liter)

10.95 →	DHX (XUD9TF/BTF)		X10-729-002-007	SWP-M-C	T1: 11
---------	------------------	--	-----------------	---------	--------

1.9 TD (68 kW | 1.9 Liter)

04.96 →	D8B (XUD9TF)		X10-729-002-007	SWP-M-C	T1: 11
---------	--------------	--	-----------------	---------	--------

2.0 HDi (69 kW | 2.0 Liter)

10.99 →	RHX		X10-729-002-007	SWP-M-C	T1: 11
---------	-----	--	-----------------	---------	--------

2.0 HDi (80 kW | 2.0 Liter)

03.00 →	RHZ (DW10ATED)		X10-729-002-007	SWP-M-C	T1: 11
---------	----------------	--	-----------------	---------	--------



			VDO		
Datum	Motorcode	Fahrgestell Nr.	Artikel Nr.	Artikelbez.	Information

CITROËN**JUMPY Kasten**

1.6 i (58 kW 1.6 Liter)					
10.95 →	1580 SPI / 220 A2.000		X10-729-002-007	SWP-M-C	T1: 11
2.0 i 16V (102 kW 2.0 Liter)					
03.00 →			X10-729-002-007	SWP-M-C	T1: 11
1.9 D (51 kW 1.9 Liter)					
04.98 →	WJZ (DW8)		X10-729-002-007	SWP-M-C	T1: 11
1.9 TD (66 kW 1.9 Liter)					
10.95 →	DHX (XUD9TF/BTF)		X10-729-002-007	SWP-M-C	T1: 11
2.0 HDi (69 kW 2.0 Liter)					
10.99 →			X10-729-002-007	SWP-M-C	T1: 11

JUMPY Pritsche/Fahrgestell

1.9 TD (68 kW 1.9 Liter)					
10.99 →			X10-729-002-007	SWP-M-C	T1: 11
2.0 HDi (69 kW 2.0 Liter)					
10.99 →			X10-729-002-007	SWP-M-C	T1: 11

XANTIA (X1)

1.6 i (65 kW 1.6 Liter)					
03.93 → 01.98	BFZ (XU5JP)		X10-729-002-007	SWP-M-C	T1: 11
1.8 i (66 kW 1.8 Liter)					
04.97 → 01.98	LFX (XU7JB)		X10-729-002-007	SWP-M-C	T1: 11
1.8 i (74 kW 1.8 Liter)					
03.93 → 01.98	LFZ (XU7JP)		X10-729-002-007	SWP-M-C	T1: 11
1.8 i 16V (81 kW 1.8 Liter)					
06.95 → 01.98	LFY (XU7JP4)		X10-729-002-007	SWP-M-C	T1: 11
2.0 i (89 kW 2.0 Liter)					
03.93 → 01.98	RFX (XU10J2C)		X10-729-002-007	SWP-M-C	T1: 11
2.0 i 16V (97 kW 2.0 Liter)					
06.95 → 01.98	RFV (XU10J4R)		X10-729-002-007	SWP-M-C	T1: 11
2.0 Turbo (108 kW 2.0 Liter)					
06.95 → 01.98	RGX (XU10J2TE)		X10-729-002-007	SWP-M-C	T1: 11
2.0 i 16V (110 kW 2.0 Liter)					
06.94 → 01.98	RFT (XU10J4Z)		X10-729-002-007	SWP-M-C	T1: 11
2.0 i 16V (112 kW 2.0 Liter)					
03.93 → 01.98	RFY (XU10J4Z)		X10-729-002-007	SWP-M-C	T1: 11
3.0 i 24V (140 kW 3.0 Liter)					
01.97 → 01.98	XFZ (ES9J4)		X10-729-002-007	SWP-M-C	T1: 11
1.9 D (50 kW 1.9 Liter)					
06.94 → 01.98	DJZ (XUD9Y)		X10-729-002-007	SWP-M-C	T1: 11
1.9 D (51 kW 1.9 Liter)					
06.94 → 01.98	D9B (XUD9A/L)		X10-729-002-007	SWP-M-C	T1: 11



			VDO		
Datum	Motorcode	Fahrgestell Nr.	Artikel Nr.	Artikelbez.	Information

CITROËN**XANTIA (X1)****1.9 SD (55 kW | 1.9 Liter)**

02.96 → 01.98	DHW (XUD9SD)		X10-729-002-007	SWP-M-C	T1: 11
---------------	--------------	--	-----------------	---------	--------

1.9 Turbo D (66 kW | 1.9 Liter)

10.94 → 01.98	DHX (XUD9TF/BTF) / DHY (XUD9TE/Y)		X10-729-002-007	SWP-M-C	T1: 11
---------------	--------------------------------------	--	-----------------	---------	--------

2.1 Turbo D 12V (80 kW | 2.1 Liter)

06.95 → 01.98	P8C (XUD11BTE)		X10-729-002-007	SWP-M-C	T1: 11
---------------	----------------	--	-----------------	---------	--------

XANTIA Break (X1)**1.8 i (66 kW | 1.8 Liter)**

04.97 → 01.98	LFX (XU7JB)		X10-729-002-007	SWP-M-C	T1: 11
---------------	-------------	--	-----------------	---------	--------

1.8 i (74 kW | 1.8 Liter)

06.95 → 01.98	LFZ (XU7JP)		X10-729-002-007	SWP-M-C	T1: 11
---------------	-------------	--	-----------------	---------	--------

1.8 i 16V (81 kW | 1.8 Liter)

06.95 → 01.98	LFY (XU7JP4)		X10-729-002-007	SWP-M-C	T1: 11
---------------	--------------	--	-----------------	---------	--------

2.0 i (89 kW | 2.0 Liter)

06.95 → 01.98	RFX (XU10J2C)		X10-729-002-007	SWP-M-C	T1: 11
---------------	---------------	--	-----------------	---------	--------

2.0 i 16V (97 kW | 2.0 Liter)

06.95 → 01.98	RFV (XU10J4R)		X10-729-002-007	SWP-M-C	T1: 11
---------------	---------------	--	-----------------	---------	--------

2.0 Turbo (108 kW | 2.0 Liter)

06.95 → 01.98	RGX (XU10J2TE)		X10-729-002-007	SWP-M-C	T1: 11
---------------	----------------	--	-----------------	---------	--------

1.9 SD (55 kW | 1.9 Liter)

04.97 → 01.98	DHW (XUD9SD)		X10-729-002-007	SWP-M-C	T1: 11
---------------	--------------	--	-----------------	---------	--------

1.9 Turbo D (66 kW | 1.9 Liter)

06.95 → 01.98	D8B (XUD9TF) / DHX (XUD9TF/BTF) / DHY (XUD9TE/Y)		X10-729-002-007	SWP-M-C	T1: 11
---------------	--------------------------------------------------------	--	-----------------	---------	--------

2.1 Turbo D 12V (80 kW | 2.1 Liter)

06.96 → 01.98	P8C (XUD11BTE)		X10-729-002-007	SWP-M-C	T1: 11
---------------	----------------	--	-----------------	---------	--------

XANTIA (X2)**1.8 i (66 kW | 1.8 Liter)**

01.98 →	LFX (XU7JB)		X10-729-002-007	SWP-M-C	T1: 11
---------	-------------	--	-----------------	---------	--------

1.8 i 16V (81 kW | 1.8 Liter)

01.98 →	LFY (XU7JP4)		X10-729-002-007	SWP-M-C	T1: 11
---------	--------------	--	-----------------	---------	--------

2.0 i (89 kW | 2.0 Liter)

01.98 →	RFX (XU10J2C)		X10-729-002-007	SWP-M-C	T1: 11
---------	---------------	--	-----------------	---------	--------

2.0 i 16V (97 kW | 2.0 Liter)

01.98 →	RFV (XU10J4R)		X10-729-002-007	SWP-M-C	T1: 11
---------	---------------	--	-----------------	---------	--------

2.0 Turbo (108 kW | 2.0 Liter)

01.98 →	RGX (XU10J2TE)		X10-729-002-007	SWP-M-C	T1: 11
---------	----------------	--	-----------------	---------	--------

3.0 V6 (140 kW | 3.0 Liter)

01.98 →	XFZ (ES9J4)		X10-729-002-007	SWP-M-C	T1: 11
---------	-------------	--	-----------------	---------	--------



			VDO		
Datum	Motorcode	Fahrgestell Nr.	Artikel Nr.	Artikelbez.	Information

CITROËN**XANTIA (X2)****1.9 SD (55 kW | 1.9 Liter)**

01.98 →	DHW (XUD9SD)		X10-729-002-007	SWP-M-C	T1: 11
---------	--------------	--	-----------------	---------	--------

1.9 Turbo D (66 kW | 1.9 Liter)

01.98 →	DHX (XUD9TF/BTF) / DHY (XUD9TE/Y)		X10-729-002-007	SWP-M-C	T1: 11
---------	--------------------------------------	--	-----------------	---------	--------

2.0 HDI 90 (66 kW | 2.0 Liter)

03.99 →			X10-729-002-007	SWP-M-C	T1: 11
---------	--	--	-----------------	---------	--------

2.0 HDI 109 (80 kW | 2.0 Liter)

02.99 →	RHZ (DW10ATED)		X10-729-002-007	SWP-M-C	T1: 11
---------	----------------	--	-----------------	---------	--------

2.1 Turbo D 12V (80 kW | 2.1 Liter)

01.98 → 02.99	P8C (XUD11BTE)		X10-729-002-007	SWP-M-C	T1: 11
---------------	----------------	--	-----------------	---------	--------

XANTIA Break (X2)**1.8 i (66 kW | 1.8 Liter)**

01.98 →	LFX (XU7JB)		X10-729-002-007	SWP-M-C	T1: 11
---------	-------------	--	-----------------	---------	--------

1.8 i 16V (81 kW | 1.8 Liter)

01.98 →	LFY (XU7JP4)		X10-729-002-007	SWP-M-C	T1: 11
---------	--------------	--	-----------------	---------	--------

2.0 i (89 kW | 2.0 Liter)

01.98 →	RFX (XU10J2C)		X10-729-002-007	SWP-M-C	T1: 11
---------	---------------	--	-----------------	---------	--------

2.0 i 16V (97 kW | 2.0 Liter)

01.98 →	RFV (XU10J4R)		X10-729-002-007	SWP-M-C	T1: 11
---------	---------------	--	-----------------	---------	--------

2.0 Turbo (108 kW | 2.0 Liter)

01.98 →	RGX (XU10J2TE)		X10-729-002-007	SWP-M-C	T1: 11
---------	----------------	--	-----------------	---------	--------

3.0 V6 (140 kW | 3.0 Liter)

01.98 →	XFZ (ES9J4)		X10-729-002-007	SWP-M-C	T1: 11
---------	-------------	--	-----------------	---------	--------

1.9 SD (55 kW | 1.9 Liter)

01.98 →	DHW (XUD9SD)		X10-729-002-007	SWP-M-C	T1: 11
---------	--------------	--	-----------------	---------	--------

1.9 Turbo D (66 kW | 1.9 Liter)

01.98 →	D8B (XUD9TF) / DHX (XUD9TF/BTF)		X10-729-002-007	SWP-M-C	T1: 11
---------	------------------------------------	--	-----------------	---------	--------

2.0 HDI 90 (66 kW | 2.0 Liter)

03.99 →	RHY (DW10TD)		X10-729-002-007	SWP-M-C	T1: 11
---------	--------------	--	-----------------	---------	--------

2.0 HDI 109 (80 kW | 2.0 Liter)

02.99 →	RHZ (DW10ATED)		X10-729-002-007	SWP-M-C	T1: 11
---------	----------------	--	-----------------	---------	--------

2.1 Turbo D 12V (80 kW | 2.1 Liter)

01.98 → 02.99	P8C (XUD11BTE)		X10-729-002-007	SWP-M-C	T1: 11
---------------	----------------	--	-----------------	---------	--------





XM (Y3)**2.0 i (79 kW | 2.0 Liter)**

05.89 → 04.94	RDZ (XU10MZ)		X10-729-002-007	SWP-M-C	T1: 11
---------------	--------------	--	-----------------	---------	--------

2.0 (84 kW | 2.0 Liter)

05.89 → 04.94			X10-729-002-007	SWP-M-C	T1: 11
---------------	--	--	-----------------	---------	--------



			VDO		
Datum	Motorcode	Fahrgestell Nr.	Artikel Nr.	Artikelbez.	Information

CITROËN

XM (Y3)

2.0 i (89 kW 2.0 Liter)					
05.89 → 06.94	RFZ (XU10J2)		X10-729-002-007	SWP-M-C	T1: 11
2.0 i Turbo (104 kW 2.0 Liter)					
09.92 → 06.94	RGY (XU10J2TE/Z)		X10-729-002-007	SWP-M-C	T1: 11
3.0 V6 (123 kW 3.0 Liter)					
05.89 → 06.94	SFZ (ZPJ/Z) / UFZ (ZPJ/Z)		X10-729-002-007	SWP-M-C	T1: 11
3.0 V6 24V (147 kW 3.0 Liter)					
07.90 → 06.94	SKZ (ZPJ4/Z) / UKZ (ZPJ4/Z)		X10-729-002-007	SWP-M-C	T1: 11
2.1 D 12V (60 kW 2.1 Liter)					
05.89 → 06.94	P9A (XUD11A)		X10-729-002-007	SWP-M-C	T1: 11
2.1 TD 12V (80 kW 2.1 Liter)					
05.89 → 06.94	P8A (XUD11ATE) / PHZ (XUD11ATE) / PJZ (XUD11ATE)		X10-729-002-007	SWP-M-C	T1: 11

XM Break (Y3)

2.0 i (Y3A) (79 kW 2.0 Liter)					
11.91 → 04.94	RDZ (XU10M2) / XU102C		X10-729-002-007	SWP-M-C	T1: 11
2.0 i (89 kW 2.0 Liter)					
11.91 → 04.94	RFZ (XU10J2)		X10-729-002-007	SWP-M-C	T1: 11
2.0 Turbo (104 kW 2.0 Liter)					
09.92 → 04.94	RGY (XU10J2TE/Z)		X10-729-002-007	SWP-M-C	T1: 11
3.0 V6 (123 kW 3.0 Liter)					
11.91 → 04.94	SFZ (ZPJ/Z) / UFZ (ZPJ/Z)		X10-729-002-007	SWP-M-C	T1: 11
2.1 D 12V (60 kW 2.1 Liter)					
11.91 → 04.94	P9A (XUD11A)		X10-729-002-007	SWP-M-C	T1: 11
2.1 TD 12V (80 kW 2.1 Liter)					
11.91 → 04.94	P8A (XUD11ATE) / PHZ (XUD11ATE) / PJZ (XUD11ATE)		X10-729-002-007	SWP-M-C	T1: 11

XM (Y4)

2.0 i 16V (97 kW 2.0 Liter)					
05.94 → 10.00	RFV (XU10J4R)		X10-729-002-007	SWP-M-C	T1: 11
2.0 Turbo (108 kW 2.0 Liter)					
05.94 → 10.00	RGX (XU10J2TE)		X10-729-002-007	SWP-M-C	T1: 11
3.0 V6 (140 kW 3.0 Liter)					
04.97 → 10.00	XFZ (ES9J4)		X10-729-002-007	SWP-M-C	T1: 11
3.0 V6 (123 kW 3.0 Liter)					
05.94 → 10.00	SFZ (ZPJ/Z) / UFZ (ZPJ/Z)		X10-729-002-007	SWP-M-C	T1: 11
3.0 V6 24V (147 kW 3.0 Liter)					
05.94 → 10.00	SKZ (ZPJ4/Z) / UKZ (ZPJ4/Z)		X10-729-002-007	SWP-M-C	T1: 11



			VDO		
Datum	Motorcode	Fahrgestell Nr.	Artikel Nr.	Artikelbez.	Information

CITROËN

XM (Y4)

2.1 TD 12V (80 kW | 2.1 Liter)

05.94 → 10.00	P8A (XUD11ATE) / P8C (XUD11BTE) / PHZ (XUD11ATE) / PJZ (XUD11ATE)		X10-729-002-007	SWP-M-C	T1: 11
---------------	----------------------------------------------------------------------------	--	-----------------	---------	--------

2.5 TD (95 kW | 2.5 Liter)

05.94 → 10.00	THY (DK5ATE)		X10-729-002-007	SWP-M-C	T1: 11
---------------	--------------	--	-----------------	---------	--------

XM Break (Y4)

2.0 i 16V (97 kW | 2.0 Liter)

05.94 → 10.00	RFV (XU10J4R)		X10-729-002-007	SWP-M-C	T1: 11
---------------	---------------	--	-----------------	---------	--------

2.0 Turbo (108 kW | 2.0 Liter)

05.94 → 10.00	RGX (XU10J2TE) / RGY (XU10J2TE/Z)		X10-729-002-007	SWP-M-C	T1: 11
---------------	--------------------------------------	--	-----------------	---------	--------

3.0 V6 (123 kW | 3.0 Liter)

05.94 → 10.00	SFZ (ZPJZ) / UFZ (ZPJZ)		X10-729-002-007	SWP-M-C	T1: 11
---------------	-------------------------	--	-----------------	---------	--------

3.0 V6 (140 kW | 3.0 Liter)

04.97 → 10.00	XFZ (ES9J4)		X10-729-002-007	SWP-M-C	T1: 11
---------------	-------------	--	-----------------	---------	--------

2.1 D12 (60 kW | 2.1 Liter)

07.94 → 06.96	P9A (XUD11A)		X10-729-002-007	SWP-M-C	T1: 11
---------------	--------------	--	-----------------	---------	--------

2.1 TD 12V (80 kW | 2.1 Liter)

05.94 → 10.00	P8C (XUD11BTE) / PHZ (XUD11ATE) / PJZ (XUD11ATE)		X10-729-002-007	SWP-M-C	T1: 11
---------------	--------------------------------------------------------	--	-----------------	---------	--------

2.5 TD (95 kW | 2.5 Liter)

05.94 → 10.00	THY (DK5ATE)		X10-729-002-007	SWP-M-C	T1: 11
---------------	--------------	--	-----------------	---------	--------

ZX (N2)

1.1 (44 kW | 1.1 Liter)

03.91 → 06.97	HDZ (TU1M)		X10-729-002-007	SWP-M-C	T1: 11
---------------	------------	--	-----------------	---------	--------

1.4 (55 kW | 1.4 Liter)

03.91 → 06.97	KDZ (TU3M/Z)		X10-729-002-007	SWP-M-C	T1: 11
---------------	--------------	--	-----------------	---------	--------

1.4 i (55 kW | 1.4 Liter)

03.91 → 06.97	KDX (TU3M/Z) / KDZ (TU3M/Z) / KFX (TU3JP)		X10-729-002-007	SWP-M-C	T1: 11
---------------	----------------------------------------------	--	-----------------	---------	--------

1.6 i (65 kW | 1.6 Liter)

03.91 → 06.97	BDY (XU5M) / BFZ (XU5JP)		X10-729-002-007	SWP-M-C	T1: 11
---------------	--------------------------	--	-----------------	---------	--------

1.8 i (74 kW | 1.8 Liter)

07.92 → 06.97	LFZ (XU7JP)		X10-729-002-007	SWP-M-C	T1: 11
---------------	-------------	--	-----------------	---------	--------





1.8 i 16V (81 kW | 1.8 Liter)

01.96 → 06.97	LFY (XU7JP4)		X10-729-002-007	SWP-M-C	T1: 11
---------------	--------------	--	-----------------	---------	--------

1.9 i (88 kW | 1.9 Liter)

03.91 → 06.97	DKZ (XU9JA)		X10-729-002-007	SWP-M-C	T1: 11
---------------	-------------	--	-----------------	---------	--------



			VDO		
Datum	Motorcode	Fahrgestell Nr.	Artikel Nr.	Artikelbez.	Information

CITROËN

ZX (N2)

2.0 i (89 kW 2.0 Liter)					
07.92 → 06.97	RFX (XU10J2C)		X10-729-002-007	SWP-M-C	T1: 11
2.0 i 16V (110 kW 2.0 Liter)					
06.94 → 06.97	RFT (XU10J4/Z)		X10-729-002-007	SWP-M-C	T1: 11
2.0 i 16V (112 kW 2.0 Liter)					
07.92 → 10.94	RFT (XU10J4/Z) / RFY (XU10J4/Z)		X10-729-002-007	SWP-M-C	T1: 11
2.0 i 16V (120 kW 2.0 Liter)					
05.96 → 06.97	RFS (XU10J4RS)		X10-729-002-007	SWP-M-C	T1: 11
1.8 D (44 kW 1.8 Liter)					
06.93 → 06.97	161A (XUD7)		X10-729-002-007	SWP-M-C	T1: 11
1.9 D (47 kW 1.9 Liter)					
03.91 → 06.97	DJZ (XUD9Y)		X10-729-002-007	SWP-M-C	T1: 11
1.9 D (50 kW 1.9 Liter)					
06.94 → 06.97	D9B (XUD9A/U)		X10-729-002-007	SWP-M-C	T1: 11
1.9 TD (66 kW 1.9 Liter)					
07.92 → 06.97	DHY (XUD9TE/Y)		X10-729-002-007	SWP-M-C	T1: 11

FIAT

BRAVA (182)

1.2 16V 80 (59 kW 1.2 Liter)					
10.00 → 10.01	188 A5.000		246-083-001-004C	SWP-D-C	T1: 1
1.2 16V 80 (60 kW 1.2 Liter)					
12.98 → 10.00	182 B2.000		246-083-001-004C	SWP-D-C	T1: 1
1.4 (182.BG) (55 kW 1.4 Liter)					
10.95 → 10.01	182 A5.000		246-083-001-004C	SWP-D-C	T1: 1
1.4 12 V (182.BA) (59 kW 1.4 Liter)					
10.95 → 10.01	182 A3.000		246-083-001-004C	SWP-D-C	T1: 1
1.6 16V (182.BH) (66 kW 1.6 Liter)					
10.95 → 10.01	182 A6.000		246-083-001-004C	SWP-D-C	T1: 1
1.6 16V (182.BB) (76 kW 1.6 Liter)					
02.96 → 10.01	182 A4.000		246-083-001-004C	SWP-D-C	T1: 1
1.8 GT 16V (182.BC) (83 kW 1.8 Liter)					
10.95 → 10.01	182 A2.000		246-083-001-004C	SWP-D-C	T1: 1
1.9 D (48 kW 1.9 Liter)					
10.95 → 10.01	160 A7.000		246-083-001-004C	SWP-D-C	T1: 1
1.9 TD 75 S (182.BF) (55 kW 1.9 Liter)					
03.96 → 10.01	182 A8.000		246-083-001-004C	SWP-D-C	T1: 1
1.9 TD 100 S (182.BF) (74 kW 1.9 Liter)					
03.96 → 10.01	182 A7.000		246-083-001-004C	SWP-D-C	T1: 1
1.9 JTD 105 (77 kW 1.9 Liter)					
12.98 → 10.01	182 B4.000		246-083-001-004C	SWP-D-C	T1: 1



			VDO		
Datum	Motorcode	Fahrgestell Nr.	Artikel Nr.	Artikelbez.	Information





FIAT**BRAVO (182)**

1.2 16V 80 (59 kW 1.2 Liter)					
10.00 → 10.01	188 A5.000		246-083-001-004C	SWP-D-C	T1: 1
1.2 16V 80 (60 kW 1.2 Liter)					
12.98 → 10.00	182 B2.000		246-083-001-004C	SWP-D-C	T1: 1
1.4 (182.AG) (55 kW 1.4 Liter)					
10.95 → 10.01	182 A5.000		246-083-001-004C	SWP-D-C	T1: 1
1.4 (182.AA) (59 kW 1.4 Liter)					
10.95 → 10.01	182 A3.000		246-083-001-004C	SWP-D-C	T1: 1
1.6 16V (182.AH) (66 kW 1.6 Liter)					
10.95 → 10.01	182 A6.000		246-083-001-004C	SWP-D-C	T1: 1
1.6 16V (182.AB) (76 kW 1.6 Liter)					
03.96 → 10.01	182 A4.000		246-083-001-004C	SWP-D-C	T1: 1
1.8 GT (182.AC) (83 kW 1.8 Liter)					
10.95 → 10.01	182 A2.000		246-083-001-004C	SWP-D-C	T1: 1
2.0 HGT 20V (182.AD) (108 kW 2.0 Liter)					
10.95 → 07.98	182 A1.000		246-083-001-004C	SWP-D-C	T1: 1
2.0 HGT 20V (182.AQ) (113 kW 2.0 Liter)					
07.98 → 10.01	182 B7.000		246-083-001-004C	SWP-D-C	T1: 1
1.9 D (48 kW 1.9 Liter)					
10.95 → 10.01	160 A7.000		246-083-001-004C	SWP-D-C	T1: 1
1.9 TD 75 S (182.AF) (55 kW 1.9 Liter)					
03.96 → 10.01	182 A8.000		246-083-001-004C	SWP-D-C	T1: 1
1.9 TD 100 S (182.AF) (74 kW 1.9 Liter)					
03.96 → 10.01	182 A7.000		246-083-001-004C	SWP-D-C	T1: 1
1.9 JTD 105 (77 kW 1.9 Liter)					
12.98 → 10.01	182 B4.000		246-083-001-004C	SWP-D-C	T1: 1

COUPE (FA/175)

1.8 16V (96 kW 1.8 Liter)					
03.96 →	183 A1.000		246-083-001-004C	SWP-D-C	T1: 1
2.0 16V (102 kW 2.0 Liter)					
11.93 → 08.96	836 A3.000		246-083-001-004C	SWP-D-C	T1: 1
2.0 20V (108 kW 2.0 Liter)					
08.96 → 04.98	182 A1.000		246-083-001-004C	SWP-D-C	T1: 1
2.0 20V (113 kW 2.0 Liter)					
04.98 →	182 B3.000		246-083-001-004C	SWP-D-C	T1: 1
2.0 16V Turbo (140 kW 2.0 Liter)					
11.93 → 08.96	175 A1.000		246-083-001-004C	SWP-D-C	T1: 1
2.0 20V Turbo (162 kW 2.0 Liter)					
08.96 →	175 A3.000		246-083-001-004C	SWP-D-C	T1: 1



			VDO		
Datum	Motorcode	Fahrgestell Nr.	Artikel Nr.	Artikelbez.	Information

FIAT**DOBLO (223)****1.2 (223AXA1A) (48 kW | 1.2 Liter)**

03.01 → 223 A5.000 246-083-001-004C SWP-D-C T1: 1

1.6 16V (223AXD1A) (76 kW | 1.6 Liter)

10.01 → 182 B6.000 246-083-001-004C SWP-D-C T1: 1

1.9 D (223AXB1A) (46 kW | 1.9 Liter)

03.01 → 223 A6.000 246-083-001-004C SWP-D-C T1: 1

1.9 JTD (223AXE1A) (74 kW | 1.9 Liter)

10.01 → 182 B9.000 246-083-001-004C SWP-D-C T1: 1

1.9 JTD (77 kW | 1.9 Liter)

07.03 → 223 A7.000 246-083-001-004C SWP-D-C T1: 1

DOBLO Cargo (223)**1.2 (223ZXA1A) (48 kW | 1.2 Liter)**

03.01 → 223 A5.000 246-083-001-004C SWP-D-C T1: 1; T8

1.6 16V (223ZXD1A) (76 kW | 1.6 Liter)

10.01 → 182 B6.000 246-083-001-004C SWP-D-C T1: 1; T8

1.3 JTD 16V (51 kW | 1.3 Liter)

05.04 → 188 A9.000 246-083-001-004C SWP-D-C T1: 1

1.9 D (223ZXB1A) (46 kW | 1.9 Liter)

03.01 → 223 A6.000 246-083-001-004C SWP-D-C T1: 1; T8

1.9 JTD (223ZXE1A) (74 kW | 1.9 Liter)

10.01 → 182 B9.000 246-083-001-004C SWP-D-C T1: 1; T8

1.9 JTD (77 kW | 1.9 Liter)

07.03 → 246-083-001-004C SWP-D-C T1: 1

IDEA**1.2 16V (59 kW | 1.2 Liter)**

01.04 → 188 A5.000 246-083-001-004C SWP-D-C T1: 1

1.4 16V (70 kW | 1.4 Liter)

01.04 → 843 A1.000 246-083-001-004C SWP-D-C T1: 1

1.3 JTD (51 kW | 1.3 Liter)

01.04 → 188 A9.000 246-083-001-004C SWP-D-C T1: 1

1.9 JTD (74 kW | 1.9 Liter)

01.04 → 188 B2.000 246-083-001-004C SWP-D-C T1: 1

MAREA (185)**1.2 16V (60 kW | 1.2 Liter)**

10.98 → 182 B2.000 246-083-001-004C SWP-D-C T1: 1

1.4 80 12V (59 kW | 1.4 Liter)

09.96 → 182 A3.000 246-083-001-004C SWP-D-C T1: 1

1.6 100 16V (76 kW | 1.6 Liter)

09.96 → 182 A4.000 246-083-001-004C SWP-D-C T1: 1



			VDO		
Datum	Motorcode	Fahrgestell Nr.	Artikel Nr.	Artikelbez.	Information

FIAT**MAREA (185)**

1.6 100 16V Bipower (76 kW 1.6 Liter)					
04.99 →	185 A3.000 / 186 A4.000		246-083-001-004C	SWP-D-C	T1: 1
1.8 115 16V (83 kW 1.8 Liter)					
09.96 →	182 A2.000		246-083-001-004C	SWP-D-C	T1: 1
2.0 150 20V (108 kW 2.0 Liter)					
09.96 → 04.99	182 A1.000		246-083-001-004C	SWP-D-C	T1: 1
2.0 150 20V (110 kW 2.0 Liter)					
01.01 →	185 A8.000		246-083-001-004C	SWP-D-C	T1: 1
2.0 155 20V (113 kW 2.0 Liter)					
04.99 → 01.01			246-083-001-004C	SWP-D-C	T1: 1
1.9 TD 75 (55 kW 1.9 Liter)					
09.96 →	182 A8.000		246-083-001-004C	SWP-D-C	T1: 1
1.9 TD 100 (74 kW 1.9 Liter)					
09.96 →	182 A7.000		246-083-001-004C	SWP-D-C	T1: 1
1.9 JTD 105 (77 kW 1.9 Liter)					
04.99 → 01.01	182 B4.000		246-083-001-004C	SWP-D-C	T1: 1
1.9 JTD 110 (81 kW 1.9 Liter)					
01.01 →	186 A6.000		246-083-001-004C	SWP-D-C	T1: 1
2.4 TD 125 (91 kW 2.4 Liter)					
09.96 → 04.99	185 A2.000		246-083-001-004C	SWP-D-C	T1: 1
2.4 JTD 130 (96 kW 2.4 Liter)					
04.99 →	185 A6.000 / 839 A5.000		246-083-001-004C	SWP-D-C	T1: 1

MAREA Weekend (185)

1.2 16V (60 kW 1.2 Liter)					
10.98 →	182 B2.000		246-083-001-004C	SWP-D-C	T1: 1
1.4 80 12V (59 kW 1.4 Liter)					
09.96 →	182 A3.000		246-083-001-004C	SWP-D-C	T1: 1
1.6 100 16V (76 kW 1.6 Liter)					
09.96 →	182 A4.000		246-083-001-004C	SWP-D-C	T1: 1
1.8 115 16V (83 kW 1.8 Liter)					
09.96 →	182 A2.000		246-083-001-004C	SWP-D-C	T1: 1
2.0 150 20V (108 kW 2.0 Liter)					
09.96 → 04.99	182 A1.000		246-083-001-004C	SWP-D-C	T1: 1
2.0 150 20V (110 kW 2.0 Liter)					
01.01 →	185 A8.000		246-083-001-004C	SWP-D-C	T1: 1
2.0 155 20V (113 kW 2.0 Liter)					
04.99 → 01.01			246-083-001-004C	SWP-D-C	T1: 1
1.9 TD 75 (55 kW 1.9 Liter)					
09.96 →	182 A8.000		246-083-001-004C	SWP-D-C	T1: 1
1.9 TD 100 (74 kW 1.9 Liter)					
09.96 →	182 A7.000		246-083-001-004C	SWP-D-C	T1: 1
1.9 JTD 105 (77 kW 1.9 Liter)					
04.99 →	182 B4.000		246-083-001-004C	SWP-D-C	T1: 1



			VDO		
Datum	Motorcode	Fahrgestell Nr.	Artikel Nr.	Artikelbez.	Information

FIAT**MAREA Weekend (185)****1.9 JTD 110 (81 kW | 1.9 Liter)**

01.01 → 186 A6.000 246-083-001-004C SWP-D-C T1: 1

2.4 TD 125 (91 kW | 2.4 Liter)

09.96 → 04.99 185 A2.000 246-083-001-004C SWP-D-C T1: 1

2.4 JTD 130 (96 kW | 2.4 Liter)

04.99 → 185 A6.000 / 839 A5.000 246-083-001-004C SWP-D-C T1: 1

MULTIPLA (186)**1.6 16V Blupower (186AMA1A) (70 kW | 1.6 Liter)**

04.99 → 186 A3.000 246-083-001-004C SWP-D-C T1: 1; T7: SX →

1.6 16V Bipower (186AMB1A) (76 kW | 1.6 Liter)

04.99 → 186 A4.000 246-083-001-004C SWP-D-C T1: 1; T7: SX →

1.6 16V Bipower (76 kW | 1.6 Liter)

10.01 → 246-083-001-004C SWP-D-C T1: 1; T7: SX →

1.6 100 16V (186AXA1A) (76 kW | 1.6 Liter)

04.99 → 182 A4.000 246-083-001-004C SWP-D-C T1: 1; T7: SX →

1.9 JTD 105 (186AXB1A) (77 kW | 1.9 Liter)

04.99 → 182 B4.000 246-083-001-004C SWP-D-C T1: 1; T7: SX →

1.9 JTD 110 (81 kW | 1.9 Liter)

03.01 → 07.02 186 A6.000 246-083-001-004C SWP-D-C T1: 1; T7: SX →

1.9 JTD 115 (85 kW | 1.9 Liter)

07.02 → 186 A8.000 246-083-001-004C SWP-D-C T1: 1; T7: SX →

PALIO (178BX)**1.0 (45 kW | 1.0 Liter)**

04.96 → 246-083-001-004C SWP-D-C T1: 1

1.0 (56 kW | 1.0 Liter)

04.96 → 246-083-001-004C SWP-D-C T1: 1

1.2 (54 kW | 1.2 Liter)

06.98 → 178 E2.000 246-083-001-004C SWP-D-C T1: 1

1.4 (51 kW | 1.4 Liter)

04.96 → 178 B2.000 246-083-001-004C SWP-D-C T1: 1

1.4 KAT (51 kW | 1.4 Liter)

04.96 → 178 B2.016 246-083-001-004C SWP-D-C T1: 1

1.5 (57 kW | 1.5 Liter)

04.96 → 06.98 246-083-001-004C SWP-D-C T1: 1

1.6 16V (74 kW | 1.6 Liter)

04.96 → 178 B3.000 246-083-001-004C SWP-D-C T1: 1

PALIO Weekend (178DX)**1.2 (178DYA1A) (44 kW | 1.2 Liter)**

02.01 → 188 A4.000 246-083-001-004C SWP-D-C T1: 1



			VDO		
Datum	Motorcode	Fahrgestell Nr.	Artikel Nr.	Artikelbez.	Information

FIAT**PALIO Weekend (178DX)****1.2 (178DX.G1A) (54 kW | 1.2 Liter)**

04.96 → 02.01 | 178 B5.000 | 246-083-001-004C | SWP-D-C | T1: 1

1.6 16V (178DX.D1A) (74 kW | 1.6 Liter)

04.96 → 02.01 | 178 B3.000 | 246-083-001-004C | SWP-D-C | T1: 1

1.6 16V (178DYC1A06) (76 kW | 1.6 Liter)

02.01 → | 182 B6.000 | 246-083-001-004C | SWP-D-C | T1: 1

1.7 TD (178DX.H1A) (51 kW | 1.7 Liter)

04.96 → 03.01 | 176 A3.000 | 246-083-001-004C | SWP-D-C | T1: 1

1.9 D (178DYD1A07) (46 kW | 1.9 Liter)

03.01 → | 223 A6.000 | 246-083-001-004C | SWP-D-C | T1: 1

PUNTO (176)**55 1.1 (40 kW | 1.1 Liter)**

09.93 → 09.99 | 176 A6.000 / 176 B2.000 | 246-083-001-004C | SWP-D-C | T1: 1

60 1.2 (43 kW | 1.2 Liter)

01.94 → 09.99 | 176 A7.000 | 246-083-001-004C | SWP-D-C | T1: 1

60 1.2 (44 kW | 1.2 Liter)

03.94 → 09.99 | 176 B1.000 / 176 B4.000 | 246-083-001-004C | SWP-D-C | T1: 1

75 1.2 (54 kW | 1.2 Liter)

01.94 → 09.99 | 176 A8.000 | 246-083-001-004C | SWP-D-C | T1: 1

85 16V 1.2 (63 kW | 1.2 Liter)

04.97 → 09.99 | 176 B9.000 | 246-083-001-004C | SWP-D-C | T1: 1

1.4 GT Turbo (96 kW | 1.4 Liter)

09.96 → 09.99 | 176 B6.000 | 246-083-001-004C | SWP-D-C | T1: 1

1.4 GT Turbo (98 kW | 1.4 Liter)

01.94 → 09.96 | 176 A4.000 | 246-083-001-004C | SWP-D-C | T1: 1

90 1.6 (65 kW | 1.6 Liter)

01.94 → 04.97 | 176 A9.000 | 246-083-001-004C | SWP-D-C | T1: 1

1.7 D (42 kW | 1.7 Liter)

04.94 → 09.97 | 176 B3.000 | 246-083-001-004C | SWP-D-C | T1: 1

60 TD 1.7 (46 kW | 1.7 Liter)

09.96 → 09.99 | 176 B7.000 | 246-083-001-004C | SWP-D-C | T1: 1

1.7 TD (51 kW | 1.7 Liter)

01.94 → 09.99 | 176 A3.000 | 246-083-001-004C | SWP-D-C | T1: 1

1.7 TD (52 kW | 1.7 Liter)

01.94 → 09.99 | 176 A5.000 | 246-083-001-004C | SWP-D-C | T1: 1





PUNTO Cabriolet (176C)**60 1.2 (43 kW | 1.2 Liter)**

04.94 → 06.00 | 176 A7.000 | 246-083-001-004C | SWP-D-C | T1: 1

60 1.2 (44 kW | 1.2 Liter)

05.95 → 06.00 | 176 B1.000 / 176 B4.000 | 246-083-001-004C | SWP-D-C | T1: 1



			VDO		
Datum	Motorcode	Fahrgestell Nr.	Artikel Nr.	Artikelbez.	Information

FIAT**PUNTO Cabriolet (176C)****85 16V 1.2 (63 kW | 1.2 Liter)**

04.97 → 06.00	176 B9.000		246-083-001-004C	SWP-D-C	T1: 1
---------------	------------	--	------------------	---------	-------

90 1.6 (65 kW | 1.6 Liter)

04.94 → 04.97	176 A9.000		246-083-001-004C	SWP-D-C	T1: 1
---------------	------------	--	------------------	---------	-------

PUNTO Van (176L)**1.1 (40 kW | 1.1 Liter)**

04.96 → 02.00	176 B2.000		246-083-001-004C	SWP-D-C	T1: 1
---------------	------------	--	------------------	---------	-------

1.7 D (42 kW | 1.7 Liter)

04.96 → 02.00	176 B3.000		246-083-001-004C	SWP-D-C	T1: 1
---------------	------------	--	------------------	---------	-------

1.7 TD (52 kW | 1.7 Liter)

04.96 → 02.00	176 A5.000		246-083-001-004C	SWP-D-C	T1: 1
---------------	------------	--	------------------	---------	-------

PUNTO (188)**1.2 60 (188.030, .050, .130, .150, .230, .250) (44 kW | 1.2 Liter)**

09.99 →	188 A4.000		246-083-001-004C	SWP-D-C	T1: 1
---------	------------	--	------------------	---------	-------

1.2 Natural Power (44 kW | 1.2 Liter)

09.03 →	188 A4.000		246-083-001-004C	SWP-D-C	T1: 1
---------	------------	--	------------------	---------	-------

1.2 16V 80 (188.233, .235, .253, .255, .333, .353, .639, .63) (59 kW | 1.2 Liter)

09.99 →	188 A5.000		246-083-001-004C	SWP-D-C	T1: 1
---------	------------	--	------------------	---------	-------

1.4 (70 kW | 1.4 Liter)

09.03 →			246-083-001-004C	SWP-D-C	T1: 1
---------	--	--	------------------	---------	-------

1.8 130 HGT (188.738, .718) (96 kW | 1.8 Liter)

09.99 →	183 A1.000 / 188 A6.000		246-083-001-004C	SWP-D-C	T1: 1
---------	-------------------------	--	------------------	---------	-------

1.3 JTD 16V (51 kW | 1.3 Liter)

06.03 →	188 A9.000		246-083-001-004C	SWP-D-C	T1: 1
---------	------------	--	------------------	---------	-------

1.9 DS 60 (188.031, .051, .231, .251) (44 kW | 1.9 Liter)

09.99 →	188 A3.000		246-083-001-004C	SWP-D-C	T1: 1
---------	------------	--	------------------	---------	-------

1.9 JTD 80 (188.237, .257, .337, .357) (59 kW | 1.9 Liter)

09.99 →	188 A2.000		246-083-001-004C	SWP-D-C	T1: 1
---------	------------	--	------------------	---------	-------

1.9 JTD (63 kW | 1.9 Liter)

10.01 →	188 A7.000		246-083-001-004C	SWP-D-C	T1: 1
---------	------------	--	------------------	---------	-------

1.9 JTD (74 kW | 1.9 Liter)

06.03 →	188 B2.000		246-083-001-004C	SWP-D-C	T1: 1
---------	------------	--	------------------	---------	-------

PUNTO Van (188AX)**1.2 60 (44 kW | 1.2 Liter)**

02.00 →	188 A4.000		246-083-001-004C	SWP-D-C	T1: 1
---------	------------	--	------------------	---------	-------

1.9 D 60 (44 kW | 1.9 Liter)

02.00 →	188 A3.000		246-083-001-004C	SWP-D-C	T1: 1
---------	------------	--	------------------	---------	-------

1.9 JTD (63 kW | 1.9 Liter)

02.00 →	188 A7.000		246-083-001-004C	SWP-D-C	T1: 1
---------	------------	--	------------------	---------	-------



			VDO		
Datum	Motorcode	Fahrgestell Nr.	Artikel Nr.	Artikelbez.	Information





FIAT**STILO (192)**

1.2 16V (192_XA1B) (59 kW 1.2 Liter)					
02.02 →	188 A5.000		246-083-001-004C	SWP-D-C	T1: 1
1.4 16V (66 kW 1.4 Liter)					
03.05 →	843 A1.000		246-083-001-004C	SWP-D-C	T1: 1
1.4 16V (70 kW 1.4 Liter)					
01.04 →	843 A1.000		246-083-001-004C	SWP-D-C	T1: 1
1.6 16V (192_XB1A) (76 kW 1.6 Liter)					
10.01 →	182 B6.000		246-083-001-004C	SWP-D-C	T1: 1
1.8 16V (192_XC1A) (98 kW 1.8 Liter)					
10.01 →	192 A4.000		246-083-001-004C	SWP-D-C	T1: 1
2.4 20V (192_XD1A) (125 kW 2.4 Liter)					
10.01 →	192 A2.000		246-083-001-004C	SWP-D-C	T1: 1
1.9 JTD (192_XF1A) (59 kW 1.9 Liter)					
02.02 →	192 A3.000		246-083-001-004C	SWP-D-C	T1: 1
1.9 D Multijet (74 kW 1.9 Liter)					
09.05 →	192 A9.000		246-083-001-004C	SWP-D-C	T1: 1
1.9 JTD (192_XE1A) (85 kW 1.9 Liter)					
10.01 →	192 A1.000		246-083-001-004C	SWP-D-C	T1: 1
1.9 D Multijet (88 kW 1.9 Liter)					
09.05 →			246-083-001-004C	SWP-D-C	T1: 1
1.9 JTD (103 kW 1.9 Liter)					
01.04 →	192 A5.000		246-083-001-004C	SWP-D-C	T1: 1
1.9 D Multijet (110 kW 1.9 Liter)					
09.05 →			246-083-001-004C	SWP-D-C	T1: 1

STILO Multi Wagon (192)

1.4 16V (66 kW 1.4 Liter)					
03.05 →	843 A1.000		246-083-001-004C	SWP-D-C	T1: 1
1.4 16V (70 kW 1.4 Liter)					
01.04 →	843 A1.000		246-083-001-004C	SWP-D-C	T1: 1
1.6 16V (76 kW 1.6 Liter)					
01.03 →	182 B6.000		246-083-001-004C	SWP-D-C	T1: 1
1.8 16V (98 kW 1.8 Liter)					
01.03 →	192 A4.000		246-083-001-004C	SWP-D-C	T1: 1
1.9 JTD (59 kW 1.9 Liter)					
01.03 →	192 A3.000		246-083-001-004C	SWP-D-C	T1: 1
1.9 D Multijet (74 kW 1.9 Liter)					
09.05 →	192 A9.000		246-083-001-004C	SWP-D-C	T1: 1
1.9 JTD (85 kW 1.9 Liter)					
01.03 →	192 A1.000		246-083-001-004C	SWP-D-C	T1: 1
1.9 D Multijet (88 kW 1.9 Liter)					
09.05 →			246-083-001-004C	SWP-D-C	T1: 1
1.9 JTD (103 kW 1.9 Liter)					
01.04 →	192 A5.000		246-083-001-004C	SWP-D-C	T1: 1



			VDO		
Datum	Motorcode	Fahrgestell Nr.	Artikel Nr.	Artikelbez.	Information

FIAT**STILO Multi Wagon (192)****1.9 D Multijet (110 kW | 1.9 Liter)**

09.05 →			246-083-001-004C	SWP-D-C	T1: 1
---------	--	--	------------------	---------	-------

TEMPRA (159)**1.4 i.e. (159.AC, 159.AX) (51 kW | 1.4 Liter)**

03.92 → 08.96	160 A1.046 / 836 A4.000		246-083-001-004C	SWP-D-C	T1: 1
---------------	-------------------------	--	------------------	---------	-------

1.4 i.e. (159.AC) (57 kW | 1.4 Liter)

03.91 → 08.96	159 A2.000		246-083-001-004C	SWP-D-C	T1: 1
---------------	------------	--	------------------	---------	-------

1.6 i.e. (159.AS, 159.AT) (55 kW | 1.6 Liter)

06.92 → 08.96	159 A3.048 / 835 C1.000		246-083-001-004C	SWP-D-C	T1: 1
---------------	-------------------------	--	------------------	---------	-------

1.6 i.e. (159.AE) (57 kW | 1.6 Liter)

06.90 → 07.92	159 A3.046		246-083-001-004C	SWP-D-C	T1: 1
---------------	------------	--	------------------	---------	-------

1.6 (63 kW | 1.6 Liter)

03.90 → 04.93	159 A3.000		246-083-001-004C	SWP-D-C	T1: 1
---------------	------------	--	------------------	---------	-------

1.6 i.e. (159.AJ) (63 kW | 1.6 Liter)

06.94 → 08.96	159 B9.000		246-083-001-004C	SWP-D-C	T1: 1
---------------	------------	--	------------------	---------	-------

1.6 i.e. (159.AJ) (66 kW | 1.6 Liter)

06.94 → 08.96	159 B9.000		246-083-001-004C	SWP-D-C	T1: 1
---------------	------------	--	------------------	---------	-------

1.8 i.e. (159.AZ) (66 kW | 1.8 Liter)

09.93 → 08.96	835 C4.000		246-083-001-004C	SWP-D-C	T1: 1
---------------	------------	--	------------------	---------	-------

1.8 i.e. (159.BY) (74 kW | 1.8 Liter)

10.94 → 08.96	836 A5.000		246-083-001-004C	SWP-D-C	T1: 1
---------------	------------	--	------------------	---------	-------

1.8 i.e. (159.AV) (76 kW | 1.8 Liter)

09.93 → 08.96	835 C2.000		246-083-001-004C	SWP-D-C	T1: 1
---------------	------------	--	------------------	---------	-------

1.8 i.e. (159.AN) (77 kW | 1.8 Liter)

03.92 → 08.96	159 A4.046		246-083-001-004C	SWP-D-C	T1: 1
---------------	------------	--	------------------	---------	-------

1.8 i.e. (159.AN) (81 kW | 1.8 Liter)

03.90 → 08.96			246-083-001-004C	SWP-D-C	T1: 1
---------------	--	--	------------------	---------	-------

2.0 i.e. (159.AP) (83 kW | 2.0 Liter)

10.90 → 08.96	159 A6.046		246-083-001-004C	SWP-D-C	T1: 1
---------------	------------	--	------------------	---------	-------

1.9 D (159.AG) (48 kW | 1.9 Liter)

07.91 → 08.96	160 A7.000		246-083-001-004C	SWP-D-C	T1: 1
---------------	------------	--	------------------	---------	-------

1.9 TD (159.AQ) (59 kW | 1.9 Liter)

07.92 → 08.96	160 B6.046		246-083-001-004C	SWP-D-C	T1: 1
---------------	------------	--	------------------	---------	-------

1.9 TD (159.CU, 159.AU, 159.AI, 159.BI) (66 kW | 1.9 Liter)

05.90 → 08.96	160 A6.000 / 160 D1.000		246-083-001-004C	SWP-D-C	T1: 1
---------------	-------------------------	--	------------------	---------	-------

TEMPRA S.W. (159)**1.4 i.e. (159.AC, 159.AX) (51 kW | 1.4 Liter)**

10.92 → 08.96	160 A1.046 / 836 A4.000		246-083-001-004C	SWP-D-C	T1: 1
---------------	-------------------------	--	------------------	---------	-------

1.4 i.e. (159.AC) (57 kW | 1.4 Liter)

03.91 → 08.96	159 A2.000		246-083-001-004C	SWP-D-C	T1: 1
---------------	------------	--	------------------	---------	-------



			VDO		
Datum	Motorcode	Fahrgestell Nr.	Artikel Nr.	Artikelbez.	Information





FIAT**TEMPRA S.W. (159)**

1.6 i.e. (159.AS, 159.AT) (55 kW 1.6 Liter)					
10.92 → 08.96	159 A3.048 / 835 C1.000		246-083-001-004C	SWP-D-C	T1: 1
1.6 i.e. (159.AE) (57 kW 1.6 Liter)					
10.90 → 08.96	159 A3.046 / 835 C1.000		246-083-001-004C	SWP-D-C	T1: 1
1.6 (63 kW 1.6 Liter)					
12.90 → 04.93	159 A3.000		246-083-001-004C	SWP-D-C	T1: 1
1.6 i.e. (159.AJ) (66 kW 1.6 Liter)					
06.94 → 08.96	159 B9.000		246-083-001-004C	SWP-D-C	T1: 1
1.8 i.e. (159.AZ) (66 kW 1.8 Liter)					
09.93 → 08.96	835 C4.000		246-083-001-004C	SWP-D-C	T1: 1
1.8 i.e. (159.BY) (74 kW 1.8 Liter)					
10.94 → 08.96	836 A5.000		246-083-001-004C	SWP-D-C	T1: 1
1.8 i.e. (159.AV) (76 kW 1.8 Liter)					
09.93 → 08.96	835 C2.000		246-083-001-004C	SWP-D-C	T1: 1
1.8 i.e. (159.AN) (77 kW 1.8 Liter)					
03.92 → 12.93	159 A4.046		246-083-001-004C	SWP-D-C	T1: 1
1.8 i.e. (159.AN) (81 kW 1.8 Liter)					
03.90 → 08.96			246-083-001-004C	SWP-D-C	T1: 1
2.0 i.e. (159.AP) (83 kW 2.0 Liter)					
01.91 → 03.95	159 A6.046		246-083-001-004C	SWP-D-C	T1: 1
2.0 i.e. 4x4 (159.AP) (83 kW 2.0 Liter)					
03.92 → 03.95	159 A6.046		246-083-001-004C	SWP-D-C	T1: 1
1.9 D (159.AG) (48 kW 1.9 Liter)					
07.91 → 08.96	160 A7.000		246-083-001-004C	SWP-D-C	T1: 1
1.9 TD (159.AQ) (59 kW 1.9 Liter)					
03.92 → 06.93	160 B6.046		246-083-001-004C	SWP-D-C	T1: 1
1.9 TD (159.AI, 159.BI, 159.CU, 159.AU) (66 kW 1.9 Liter)					
07.91 → 02.95	160 A6.000 / 160 D1.000		246-083-001-004C	SWP-D-C	T1: 1

TIPO (160)

1.1 (160.AA) (41 kW 1.1 Liter)					
01.88 → 10.91	160 A3.000		246-083-001-004C	SWP-D-C	T1: 1
1.4 i.e. (160.AP, 160.AD, 160.EA) (51 kW 1.4 Liter)					
03.93 → 04.95	160 A1.046 / 836 A4.000		246-083-001-004C	SWP-D-C	T1: 1
1.4 (160.AC) (52 kW 1.4 Liter)					
07.87 → 12.89	160 A1.000 / 160 A1.048		246-083-001-004C	SWP-D-C	T1: 1
1.4 i.e. (57 kW 1.4 Liter)					
03.93 → 04.95			246-083-001-004C	SWP-D-C	T1: 1
1.6 i.e. (160.A1, 160.EC, 160.EB) (55 kW 1.6 Liter)					
03.93 → 04.95	159 A3.048 / 835 C1.000		246-083-001-004C	SWP-D-C	T1: 1
1.6 i.e. (160.AF) (57 kW 1.6 Liter)					
07.90 → 01.93	159 A3.046		246-083-001-004C	SWP-D-C	T1: 1
1.6 (160.AE) (61 kW 1.6 Liter)					
01.88 → 10.91	160 A2.000		246-083-001-004C	SWP-D-C	T1: 1



			VDO		
Datum	Motorcode	Fahrgestell Nr.	Artikel Nr.	Artikelbez.	Information

FIAT**TIPO (160)**

1.6 i.e. (66 kW 1.6 Liter)					
02.88 → 05.91	149 C2.046		246-083-001-004C	SWP-D-C	T1: 1
1.8 i.e. (66 kW 1.8 Liter)					
09.93 → 04.95	835 C4.000		246-083-001-004C	SWP-D-C	T1: 1
1.8 i.e. (71 kW 1.8 Liter)					
03.93 → 04.95	836 A5.000		246-083-001-004C	SWP-D-C	T1: 1
1.8 i.e. (160.AM) (74 kW 1.8 Liter)					
10.94 → 04.95	159 A4.000		246-083-001-004C	SWP-D-C	T1: 1
1.8 i.e. (160.ED) (76 kW 1.8 Liter)					
04.93 → 04.95	835 C2.000		246-083-001-004C	SWP-D-C	T1: 1
1.8 i.e. (160.AY) (77 kW 1.8 Liter)					
10.90 → 06.93	159 A4.046		246-083-001-004C	SWP-D-C	T1: 1
1.8 i.e. (81 kW 1.8 Liter)					
10.90 → 06.93			246-083-001-004C	SWP-D-C	T1: 1
1.8 i.e.16V Sport (100 kW 1.8 Liter)					
11.89 → 06.92	160 A5.000		246-083-001-004C	SWP-D-C	T1: 1
2.0 i.e. (160.AJ) (80 kW 2.0 Liter)					
06.90 → 03.92	159 A5.046		246-083-001-004C	SWP-D-C	T1: 1
2.0 i.e. (160.AT, 160.AJ) (83 kW 2.0 Liter)					
03.93 → 04.95	159 A6.046		246-083-001-004C	SWP-D-C	T1: 1
2.0 i.e. 16V Sport (160.EF) (102 kW 2.0 Liter)					
03.93 → 04.95	836 A3.000		246-083-001-004C	SWP-D-C	T1: 1
2.0 16V (160.AV) (107 kW 2.0 Liter)					
03.93 → 04.95	160 A8.046		246-083-001-004C	SWP-D-C	T1: 1
1.7 D (160.AG) (43 kW 1.7 Liter)					
03.93 → 10.94	149 B4.000		246-083-001-004C	SWP-D-C	T1: 1
1.7 D (160.AG) (45 kW 1.7 Liter)					
03.93 → 10.95			246-083-001-004C	SWP-D-C	T1: 1
1.9 D (48 kW 1.9 Liter)					
03.93 → 08.96	160 A7.000		246-083-001-004C	SWP-D-C	T1: 1
1.9 TD (160.AW) (59 kW 1.9 Liter)					
03.92 → 06.93	160 B6.046		246-083-001-004C	SWP-D-C	T1: 1
1.9 TD (160.EL, 160.GL, 160.AQ, 160.EI, 160.AR) (66 kW 1.9 Liter)					
03.93 → 04.95	160 A6.000 / 160 A6.046 / 160 D1.000		246-083-001-004C	SWP-D-C	T1: 1

FORD**COUGAR (EC_)**

2.0 16V (96 kW 2.0 Liter)					
08.98 → 12.01	EDBA / EDBB / EDBC / EDBD		X10-729-002-004	SWP-M-C	T1: 9
2.5 V6 24V (125 kW 2.5 Liter)					
06.00 → 12.01	LCBB / LCBC / LCBE		X10-729-002-004	SWP-M-C	T1: 9



			VDO		
Datum	Motorcode	Fahrgestell Nr.	Artikel Nr.	Artikelbez.	Information

FORD**COUGAR (EC_)****2.5 V6 24V (125 kW | 2.5 Liter)**

08.98 → 12.01	LCBA		X10-729-002-004	SWP-M-C	T1: 9
---------------	------	--	-----------------	---------	-------

2.5 ST 200 (151 kW | 2.5 Liter)

01.00 → 12.01	SGA		X10-729-002-004	SWP-M-C	T1: 9
---------------	-----	--	-----------------	---------	-------

ESCORT III (GAA)**1.1 (37 kW | 1.1 Liter)**

08.83 → 12.85	GSE		X10-729-002-008	SWP-M-C	T1: 12
---------------	-----	--	-----------------	---------	--------

1.1 (40 kW | 1.1 Liter)

09.80 → 08.83	GLB / GMA		X10-729-002-008	SWP-M-C	T1: 12
---------------	-----------	--	-----------------	---------	--------

1.1 (43 kW | 1.1 Liter)

09.80 → 08.83	GPA		X10-729-002-008	SWP-M-C	T1: 12
---------------	-----	--	-----------------	---------	--------

1.3 (51 kW | 1.3 Liter)

09.80 → 12.85	JPA		X10-729-002-008	SWP-M-C	T1: 12
---------------	-----	--	-----------------	---------	--------

1.6 (48 kW | 1.6 Liter)

05.83 → 07.86	CHT 1600		X10-729-002-008	SWP-M-C	T1: 12
---------------	----------	--	-----------------	---------	--------

1.6 (58 kW | 1.6 Liter)

09.80 → 12.85	LP1 / LPA		X10-729-002-008	SWP-M-C	T1: 12
---------------	-----------	--	-----------------	---------	--------

1.6 i (GAA) (66 kW | 1.6 Liter)

07.85 → 12.85	L4B		X10-729-002-008	SWP-M-C	T1: 12
---------------	-----	--	-----------------	---------	--------

1.6 (71 kW | 1.6 Liter)

09.80 → 10.82	LUA		X10-729-002-008	SWP-M-C	T1: 12
---------------	-----	--	-----------------	---------	--------

1.6 XR3i (77 kW | 1.6 Liter)

10.82 → 12.85	LR1 / LRA		X10-729-002-008	SWP-M-C	T1: 12
---------------	-----------	--	-----------------	---------	--------

RS 1600i (85 kW | 1.6 Liter)

05.82 → 12.85			X10-729-002-008	SWP-M-C	T1: 12
---------------	--	--	-----------------	---------	--------

1.6 RS Turbo (97 kW | 1.6 Liter)

11.84 → 12.85	LNA		X10-729-002-008	SWP-M-C	T1: 12
---------------	-----	--	-----------------	---------	--------

1.6 D (40 kW | 1.6 Liter)

02.84 → 12.85	LTA		X10-729-002-008	SWP-M-C	T1: 12
---------------	-----	--	-----------------	---------	--------

ESCORT III Cabriolet (ALD)**1.3 (51 kW | 1.3 Liter)**

09.83 → 12.85	JPA		X10-729-002-008	SWP-M-C	T1: 12
---------------	-----	--	-----------------	---------	--------

1.6 (58 kW | 1.6 Liter)

09.83 → 12.85	LP1 / LPA		X10-729-002-008	SWP-M-C	T1: 12
---------------	-----------	--	-----------------	---------	--------

1.6 i (77 kW | 1.6 Liter)

09.83 → 12.85	LR1 / LRA		X10-729-002-008	SWP-M-C	T1: 12
---------------	-----------	--	-----------------	---------	--------



			VDO		
Datum	Motorcode	Fahrgestell Nr.	Artikel Nr.	Artikelbez.	Information

FORD**ESCORT IV (GAF, AWF, ABFT)****1.1 (37 kW | 1.1 Liter)**

09.88 → 07.90	GSG		X10-729-002-004	SWP-M-C	T1: 9; T7: C →
09.88 → 07.90	GSG		X10-729-002-005	SWP-M-C	T1: 9; T7: C →; T8

1.3 (44 kW | 1.3 Liter)

09.88 → 07.90	JBB / JLA / JLB		X10-729-002-004	SWP-M-C	T1: 9; T7: C →
09.88 → 07.90	JBB / JLA / JLB		X10-729-002-005	SWP-M-C	T1: 9; T7: C →; T8

1.3 (GAF) (46 kW | 1.3 Liter)

09.88 → 10.90	JBA		X10-729-002-004	SWP-M-C	T1: 9; T7: C →
09.88 → 10.90	JBA		X10-729-002-005	SWP-M-C	T1: 9; T7: C →; T8

1.3 (51 kW | 1.3 Liter)

11.86 → 07.88			X10-729-002-005	SWP-M-C	T1: 9
---------------	--	--	-----------------	---------	-------

1.4 (51 kW | 1.4 Liter)

09.88 → 10.90	FUAA		X10-729-002-004	SWP-M-C	T1: 9; T7: C →
09.88 → 10.90	FUAA		X10-729-002-005	SWP-M-C	T1: 9; T7: C →; T8

1.4 (54 kW | 1.4 Liter)

09.88 → 07.90	F6B / F6D / FUC		X10-729-002-004	SWP-M-C	T1: 9; T7: C →
09.88 → 07.90	F6B / F6D / FUC		X10-729-002-005	SWP-M-C	T1: 9; T7: C →; T8

1.4 (55 kW | 1.4 Liter)

09.88 → 07.90	FUA		X10-729-002-004	SWP-M-C	T1: 9; T7: C →
09.88 → 07.90	FUA		X10-729-002-005	SWP-M-C	T1: 9; T7: C →; T8

1.6 (58 kW | 1.6 Liter)

09.88 → 12.88	LP2		X10-729-002-004	SWP-M-C	T1: 9; T7: C →
09.88 → 12.88	LP2		X10-729-002-005	SWP-M-C	T1: 9; T7: C →; T8

1.6 (65 kW | 1.6 Liter)

04.89 → 07.90	LUG		X10-729-002-004	SWP-M-C	T1: 9; T7: C →
04.89 → 07.90	LUG		X10-729-002-005	SWP-M-C	T1: 9; T7: C →; T8

1.6 i (66 kW | 1.6 Liter)

09.88 → 05.90	L4B		X10-729-002-004	SWP-M-C	T1: 9; T7: C →
09.88 → 05.90	L4B		X10-729-002-005	SWP-M-C	T1: 9; T7: C →; T8

1.6 i (75 kW | 1.6 Liter)

08.89 → 07.90	LJB		X10-729-002-004	SWP-M-C	T1: 9; T7: C →
08.89 → 07.90	LJB		X10-729-002-005	SWP-M-C	T1: 9; T7: C →; T8

1.6 XR3i (77 kW | 1.6 Liter)

09.88 → 08.89	LR2 / LRB		X10-729-002-004	SWP-M-C	T1: 9; T7: C →
09.88 → 08.89	LR2 / LRB		X10-729-002-005	SWP-M-C	T1: 9; T7: C →; T8

1.6 Turbo RS (97 kW | 1.6 Liter)

09.88 → 07.90	LNB		X10-729-002-004	SWP-M-C	T1: 9; T7: C →
09.88 → 07.90	LNB		X10-729-002-005	SWP-M-C	T1: 9; T7: C →; T8

1.6 D (40 kW | 1.6 Liter)

09.88 → 01.89	LTC		X10-729-002-004	SWP-M-C	T1: 9; T7: C →
09.88 → 01.89	LTC		X10-729-002-005	SWP-M-C	T1: 9; T7: C →; T8

1.8 D (44 kW | 1.8 Liter)

01.89 → 07.90	RTA / RTB		X10-729-002-004	SWP-M-C	T1: 9; T7: C →
01.89 → 07.90	RTA / RTB		X10-729-002-005	SWP-M-C	T1: 9; T7: C →; T8



			VDO		
Datum	Motorcode	Fahrgestell Nr.	Artikel Nr.	Artikelbez.	Information

FORD**ESCORT IV Kombi (AWF, AVF)**

1.1 (37 kW 1.1 Liter)					
08.88 → 09.90			X10-729-002-005	SWP-M-C	T1: 9; T7: CL →>; T8
1.3 (44 kW 1.3 Liter)					
08.88 → 07.90	JBB / JLA / JLB		X10-729-002-005	SWP-M-C	T1: 9; T7: CL →>; T8
1.3 (51 kW 1.3 Liter)					
11.86 → 07.88			X10-729-002-005	SWP-M-C	T1: 9
1.4 (51 kW 1.4 Liter)					
08.88 → 10.90			X10-729-002-005	SWP-M-C	T1: 9; T7: CL →>; T8
1.4 (54 kW 1.4 Liter)					
08.88 → 07.90	F6B / F6D / FUC		X10-729-002-005	SWP-M-C	T1: 9; T7: CL →>; T8
1.4 (55 kW 1.4 Liter)					
08.88 → 07.90	FUA		X10-729-002-005	SWP-M-C	T1: 9; T7: CL →>; T8
1.6 (58 kW 1.6 Liter)					
08.88 → 07.90	LP2		X10-729-002-005	SWP-M-C	T1: 9; T7: CL →>; T8
1.6 i (66 kW 1.6 Liter)					
08.88 → 07.90	L4B		X10-729-002-005	SWP-M-C	T1: 9; T7: CL →>; T8
1.6 D (40 kW 1.6 Liter)					
08.88 → 01.89	LTC		X10-729-002-005	SWP-M-C	T1: 9; T7: CL →>; T8
1.8 D (44 kW 1.8 Liter)					
01.89 → 07.90	RTA / RTB		X10-729-002-005	SWP-M-C	T1: 9; T7: CL →>; T8

ESCORT IV Cabriolet (ALF)

1.4 (54 kW 1.4 Liter)					
02.87 → 07.90	F6B / F6D / FUC		X10-729-002-005	SWP-M-C	T1: 9
1.4 (55 kW 1.4 Liter)					
01.86 → 07.90	FUA		X10-729-002-005	SWP-M-C	T1: 9
1.6 (58 kW 1.6 Liter)					
01.86 → 12.87	LP2		X10-729-002-005	SWP-M-C	T1: 9
1.6 i (66 kW 1.6 Liter)					
01.86 → 07.90	L4B		X10-729-002-005	SWP-M-C	T1: 9
1.6 i (75 kW 1.6 Liter)					
08.89 → 07.90	LJB		X10-729-002-005	SWP-M-C	T1: 9
1.6 XR3i (77 kW 1.6 Liter)					
01.86 → 07.90	LR2 / LRB		X10-729-002-005	SWP-M-C	T1: 9

ESCORT V (GAL)

1.3 (44 kW 1.3 Liter)					
07.90 → 09.92	J4B / J6A		X10-729-002-004	SWP-M-C	T1: 9; T7: CL →>; Ghia →>; T8
07.90 → 09.92	J4B / J6A		X10-729-002-005	SWP-M-C	T1: 9



			VDO		
Datum	Motorcode	Fahrgestell Nr.	Artikel Nr.	Artikelbez.	Information

FORD**ESCORT V (GAL)****1.4 (52 kW | 1.4 Liter)**

07.90 → 09.92	F6F / F6G		X10-729-002-004	SWP-M-C	T1: 9; T7: CL →; Ghia →; T8
07.90 → 09.92	F6F / F6G		X10-729-002-005	SWP-M-C	T1: 9

1.6 (66 kW | 1.6 Liter)

07.90 → 08.92	LUJ / LUK		X10-729-002-004	SWP-M-C	T1: 9; T7: CL →; Ghia →; T8
07.90 → 08.92	LUJ / LUK		X10-729-002-005	SWP-M-C	T1: 9

1.6 (77 kW | 1.6 Liter)

07.90 → 12.92	LJF		X10-729-002-004	SWP-M-C	T1: 9; T7: CL →; Ghia →; T8
07.90 → 12.92	LJF		X10-729-002-005	SWP-M-C	T1: 9

1.8 16V XR3i (77 kW | 1.8 Liter)

02.92 → 12.92	RDA		X10-729-002-004	SWP-M-C	T1: 9; T7: CL →; Ghia →; T8
02.92 → 12.92	RDA		X10-729-002-005	SWP-M-C	T1: 9

1.8 16V XR3i (96 kW | 1.8 Liter)

02.92 → 12.92	RQB		X10-729-002-004	SWP-M-C	T1: 9; T7: CL →; Ghia →; T8
02.92 → 12.92	RQB		X10-729-002-005	SWP-M-C	T1: 9

RS 2000 (110 kW | 2.0 Liter)

05.91 → 12.92	N7A		X10-729-002-004	SWP-M-C	T1: 9; T7: CL →; Ghia →; T8
05.91 → 12.92	N7A		X10-729-002-005	SWP-M-C	T1: 9

1.8 D (44 kW | 1.8 Liter)

07.90 → 12.92	RTE / RTF / RTH		X10-729-002-004	SWP-M-C	T1: 9; T7: CL →; Ghia →; T8
07.90 → 12.92	RTE / RTF / RTH		X10-729-002-005	SWP-M-C	T1: 9

ESCORT V Kombi (GAL, AVL)**1.3 (44 kW | 1.3 Liter)**

09.91 → 09.92	J4B / J6A		X10-729-002-004	SWP-M-C	T1: 9; T7: CL →
---------------	-----------	--	-----------------	---------	-----------------

1.4 (52 kW | 1.4 Liter)

07.90 → 09.92	F6F / F6G		X10-729-002-004	SWP-M-C	T1: 9; T7: CL →
---------------	-----------	--	-----------------	---------	-----------------

1.6 (66 kW | 1.6 Liter)

07.90 → 08.92	LUJ / LUK		X10-729-002-004	SWP-M-C	T1: 9; T7: CL →
---------------	-----------	--	-----------------	---------	-----------------

1.6 (77 kW | 1.6 Liter)

07.90 → 09.92	LJF		X10-729-002-004	SWP-M-C	T1: 9; T7: CL →
---------------	-----	--	-----------------	---------	-----------------

1.8 16V (77 kW | 1.8 Liter)

02.92 → 12.92	RDA		X10-729-002-004	SWP-M-C	T1: 9; T7: CL →
---------------	-----	--	-----------------	---------	-----------------

1.8 D (44 kW | 1.8 Liter)

07.90 → 12.92	RTE / RTF / RTH		X10-729-002-004	SWP-M-C	T1: 9; T7: CL →
---------------	-----------------	--	-----------------	---------	-----------------



			VDO		
Datum	Motorcode	Fahrgestell Nr.	Artikel Nr.	Artikelbez.	Information

FORD**ESCORT V Cabriolet (ALL)**

1.4 (52 kW 1.4 Liter)					
07.90 → 12.92	F6F / F6G		X10-729-002-004	SWP-M-C	T1: 9
1.6 (77 kW 1.6 Liter)					
07.90 → 12.92	LJF		X10-729-002-004	SWP-M-C	T1: 9
1.8 16V XR3i (77 kW 1.8 Liter)					
02.92 → 12.92	RDA		X10-729-002-004	SWP-M-C	T1: 9
1.8 16V XR3i (96 kW 1.8 Liter)					
02.92 → 12.92	RQB		X10-729-002-004	SWP-M-C	T1: 9

ESCORT VI (GAL)

1.3 (44 kW 1.3 Liter)					
09.92 → 01.95	J4B / J6A		X10-729-002-004	SWP-M-C	T1: 9; T7: CL →>; Ghia →>; T8
1.4 (52 kW 1.4 Liter)					
09.92 → 01.95	F6F / F6G		X10-729-002-004	SWP-M-C	T1: 9; T7: CL →>; Ghia →>; T8
1.4 (55 kW 1.4 Liter)					
01.94 → 01.95	FUH		X10-729-002-004	SWP-M-C	T1: 9; T7: CL →>; Ghia →>; T8
1.6 i 16V (65 kW 1.6 Liter)					
01.94 → 01.95	L1H		X10-729-002-004	SWP-M-C	T1: 9; T7: CL →>; Ghia →>; T8
1.6 i 16V (66 kW 1.6 Liter)					
09.92 → 01.95	L1E		X10-729-002-004	SWP-M-C	T1: 9; T7: CL →>; Ghia →>; T8
1.8 i 16V (77 kW 1.8 Liter)					
09.92 → 01.95	RDA		X10-729-002-004	SWP-M-C	T1: 9; T7: CL →>; Ghia →>; T8
1.8 XR3i 16V 4x4 (77 kW 1.8 Liter)					
08.93 → 01.95	RDA		X10-729-002-004	SWP-M-C	T1: 9; T7: CL →>; Ghia →>; T8
1.8 XR3i 16V 4x4 (96 kW 1.8 Liter)					
08.93 → 01.95	RQB		X10-729-002-004	SWP-M-C	T1: 9; T7: CL →>; Ghia →>; T8
RS 2000 (110 kW 2.0 Liter)					
09.92 → 01.95	N7A		X10-729-002-004	SWP-M-C	T1: 9; T7: CL →>; Ghia →>; T8
RS 2000 4x4 (110 kW 2.0 Liter)					
08.93 → 01.95	N7A		X10-729-002-004	SWP-M-C	T1: 9; T7: CL →>; Ghia →>; T8
RS Cosworth 4x4 (162 kW 2.0 Liter)					
09.92 → 01.95	N5F		X10-729-002-004	SWP-M-C	T1: 9; T7: CL →>; Ghia →>; T8



			VDO		
Datum	Motorcode	Fahrgestell Nr.	Artikel Nr.	Artikelbez.	Information

FORD**ESCORT VI (GAL)****1.8 D (44 kW | 1.8 Liter)**

09.92 → 01.95	RTE / RTF / RTH		X10-729-002-004	SWP-M-C	T1: 9; T7: CL →; Ghia →; T8
---------------	-----------------	--	-----------------	---------	--------------------------------

1.8 TD (66 kW | 1.8 Liter)

02.93 → 01.95	RFD / RFK / RFS		X10-729-002-004	SWP-M-C	T1: 9; T7: CL →; Ghia →; T8
---------------	-----------------	--	-----------------	---------	--------------------------------

ESCORT VI Kombi (GAL)**1.3 (44 kW | 1.3 Liter)**

09.92 → 01.95	J4B / J6A		X10-729-002-004	SWP-M-C	T1: 9; T7: CL →
---------------	-----------	--	-----------------	---------	-----------------

1.4 (52 kW | 1.4 Liter)

09.92 → 01.94	F6F / F6G		X10-729-002-004	SWP-M-C	T1: 9; T7: CL →
---------------	-----------	--	-----------------	---------	-----------------

1.4 (55 kW | 1.4 Liter)

01.94 → 01.95	F4B		X10-729-002-004	SWP-M-C	T1: 9; T7: CL →
---------------	-----	--	-----------------	---------	-----------------

1.6 i 16V (65 kW | 1.6 Liter)

01.94 → 01.95	L1H		X10-729-002-004	SWP-M-C	T1: 9; T7: CL →
---------------	-----	--	-----------------	---------	-----------------

1.6 i 16V (66 kW | 1.6 Liter)

09.92 → 01.95	L1E		X10-729-002-004	SWP-M-C	T1: 9; T7: CL →
---------------	-----	--	-----------------	---------	-----------------

1.8 i 16V (77 kW | 1.8 Liter)

01.93 → 01.95	RDA		X10-729-002-004	SWP-M-C	T1: 9; T7: CL →
---------------	-----	--	-----------------	---------	-----------------

1.8 i 16V (96 kW | 1.8 Liter)

02.93 → 01.95	RQB		X10-729-002-004	SWP-M-C	T1: 9; T7: CL →
---------------	-----	--	-----------------	---------	-----------------

1.8 D (44 kW | 1.8 Liter)

09.92 → 01.95	RTH		X10-729-002-004	SWP-M-C	T1: 9; T7: CL →
---------------	-----	--	-----------------	---------	-----------------

1.8 TD (66 kW | 1.8 Liter)

02.93 → 01.95	RFD / RFK		X10-729-002-004	SWP-M-C	T1: 9; T7: CL →
---------------	-----------	--	-----------------	---------	-----------------

ESCORT VII (GAL, AAL, ABL)**1.3 (44 kW | 1.3 Liter)**

01.95 → 10.98	J4B / J6A		X10-729-002-004	SWP-M-C	T1: 9; T7: CL →; Ghia →; T8
---------------	-----------	--	-----------------	---------	--------------------------------

1.4 (55 kW | 1.4 Liter)

01.95 → 10.98	F4B		X10-729-002-004	SWP-M-C	T1: 9; T7: CL →; Ghia →; T8
---------------	-----	--	-----------------	---------	--------------------------------

1.6 i 16V (65 kW | 1.6 Liter)

01.95 → 08.95	L1H		X10-729-002-004	SWP-M-C	T1: 9; T7: CL →; Ghia →; T8
---------------	-----	--	-----------------	---------	--------------------------------

1.6 16V (66 kW | 1.6 Liter)

01.95 → 10.98	L1E		X10-729-002-004	SWP-M-C	T1: 9; T7: CL →; Ghia →; T8
---------------	-----	--	-----------------	---------	--------------------------------

1.6 16V 4x4 (66 kW | 1.6 Liter)

01.95 → 10.98	L1E		X10-729-002-004	SWP-M-C	T1: 9; T7: CL →; Ghia →; T8
---------------	-----	--	-----------------	---------	--------------------------------



			VDO		
Datum	Motorcode	Fahrgestell Nr.	Artikel Nr.	Artikelbez.	Information

FORD**ESCORT VII (GAL, AAL, ABL)**

1.8 16V (77 kW 1.8 Liter)					
01.95 → 08.95	RDA		X10-729-002-004	SWP-M-C	T1: 9; T7: CL →; Ghia →; T8
1.8 16V (85 kW 1.8 Liter)					
01.95 → 10.98	RKC		X10-729-002-004	SWP-M-C	T1: 9; T7: CL →; Ghia →; T8
RS 2000 (110 kW 2.0 Liter)					
02.95 → 02.98	N7A		X10-729-002-004	SWP-M-C	T1: 9; T7: CL →; Ghia →; T8
RS 2000 4x4 (110 kW 2.0 Liter)					
02.95 → 10.98	N7A		X10-729-002-004	SWP-M-C	T1: 9; T7: CL →; Ghia →; T8
RS Cosworth 4x4 (162 kW 2.0 Liter)					
02.95 → 10.98	N5F		X10-729-002-004	SWP-M-C	T1: 9; T7: CL →; Ghia →; T8
1.8 D (44 kW 1.8 Liter)					
01.95 → 12.96	RTE / RTF / RTH		X10-729-002-004	SWP-M-C	T1: 9; T7: CL →; Ghia →; T8
1.8 Turbo D (51 kW 1.8 Liter)					
12.95 → 10.98	RVA		X10-729-002-004	SWP-M-C	T1: 9; T7: CL →; Ghia →; T8
1.8 TD (66 kW 1.8 Liter)					
01.95 → 10.98	RFD / RFK		X10-729-002-004	SWP-M-C	T1: 9; T7: CL →; Ghia →; T8

ESCORT VII Kombi (GAL, ANL)

1.3 (44 kW 1.3 Liter)					
01.95 → 10.98	J4B / J6A		X10-729-002-004	SWP-M-C	T1: 9; T7: CL →
1.4 (55 kW 1.4 Liter)					
01.95 → 02.99	F4B / FUH		X10-729-002-004	SWP-M-C	T1: 9; T7: CL →
1.6 i 16V (65 kW 1.6 Liter)					
01.95 → 08.95	L1H		X10-729-002-004	SWP-M-C	T1: 9; T7: CL →
1.6 16V (66 kW 1.6 Liter)					
01.95 → 02.99	L1E		X10-729-002-004	SWP-M-C	T1: 9; T7: CL →
1.8 16V (77 kW 1.8 Liter)					
01.95 → 08.95	RDA		X10-729-002-004	SWP-M-C	T1: 9; T7: CL →
1.8 16V (85 kW 1.8 Liter)					
01.95 → 02.99	RKC		X10-729-002-004	SWP-M-C	T1: 9; T7: CL →
1.8 D (44 kW 1.8 Liter)					
01.95 → 02.99			X10-729-002-004	SWP-M-C	T1: 9; T7: CL →
1.8 Turbo D (51 kW 1.8 Liter)					
12.95 → 02.99	RVA		X10-729-002-004	SWP-M-C	T1: 9; T7: CL →
1.8 TD (66 kW 1.8 Liter)					
01.95 → 02.99	RFD / RFK		X10-729-002-004	SWP-M-C	T1: 9; T7: CL →



			VDO		
Datum	Motorcode	Fahrgestell Nr.	Artikel Nr.	Artikelbez.	Information

FORD**ESCORT VII Cabriolet (ALL)****1.4 (55 kW | 1.4 Liter)**

02.95 → 09.97 F4B X10-729-002-004 SWP-M-C T1: 9

1.6 16V XR3i (65 kW | 1.6 Liter)

02.95 → 12.96 L1H X10-729-002-004 SWP-M-C T1: 9

1.6 16V XR3i (66 kW | 1.6 Liter)

02.95 → 09.97 L1E X10-729-002-004 SWP-M-C T1: 9

1.8 16V XR3i (77 kW | 1.8 Liter)

02.95 → 09.97 X10-729-002-004 SWP-M-C T1: 9

1.8 16V XR3i (85 kW | 1.8 Liter)

10.95 → 09.97 RKC X10-729-002-004 SWP-M-C T1: 9

1.8 16V XR3i (96 kW | 1.8 Liter)

02.95 → 09.97 RQB X10-729-002-004 SWP-M-C T1: 9

1.8 Turbo D (51 kW | 1.8 Liter)

10.96 → 09.97 RVA X10-729-002-004 SWP-M-C T1: 9

1.8 TD (66 kW | 1.8 Liter)

09.95 → 09.97 RFD / RFK X10-729-002-004 SWP-M-C T1: 9

FIESTA I**0.9 (29 kW | 0.9 Liter)**

05.76 → 08.83 TKA / TKW X10-729-002-005 SWP-M-C T1: 9

05.76 → 08.83 TKA / TKW X10-729-002-008 SWP-M-C T1: 12

0.9 (33 kW | 0.9 Liter)

05.76 → 08.83 TLA X10-729-002-005 SWP-M-C T1: 9

05.76 → 08.83 TLA X10-729-002-008 SWP-M-C T1: 12

1.1 (39 kW | 1.1 Liter)

05.76 → 08.83 GLA X10-729-002-005 SWP-M-C T1: 9

05.76 → 08.83 GLA X10-729-002-008 SWP-M-C T1: 12

1.1 (WFBT) (40 kW | 1.1 Liter)

02.81 → 08.83 GLW X10-729-002-005 SWP-M-C T1: 9

02.81 → 08.83 GLW X10-729-002-008 SWP-M-C T1: 12

1.3 (49 kW | 1.3 Liter)

08.77 → 08.83 J3E X10-729-002-005 SWP-M-C T1: 9

08.77 → 08.83 J3E X10-729-002-008 SWP-M-C T1: 12

1.6 XR2 (62 kW | 1.6 Liter)

08.81 → 08.83 L3E X10-729-002-005 SWP-M-C T1: 9





08.81 → 08.83 L3E X10-729-002-008 SWP-M-C T1: 12

FIESTA II (FBD)**1.0 (FBD) (33 kW | 1.0 Liter)**

09.83 → 02.89 TKB X10-729-002-005 SWP-M-C T1: 9

09.83 → 02.89 TKB X10-729-002-008 SWP-M-C T1: 12



			VDO		
Datum	Motorcode	Fahrgestell Nr.	Artikel Nr.	Artikelbez.	Information

FORD**FIESTA II (FBD)****1.0 (33 kW | 1.0 Liter)**

09.83 → 11.89			X10-729-002-005	SWP-M-C	T1: 9
09.83 → 11.89			X10-729-002-008	SWP-M-C	T1: 12

1.1 (FBD) (36 kW | 1.1 Liter)

05.86 → 02.89	GSH		X10-729-002-005	SWP-M-C	T1: 9
05.86 → 02.89	GSH		X10-729-002-008	SWP-M-C	T1: 12

1.1 (FBD) (37 kW | 1.1 Liter)

09.83 → 02.89	GLC / GSF		X10-729-002-005	SWP-M-C	T1: 9
09.83 → 02.89	GLC / GSF		X10-729-002-008	SWP-M-C	T1: 12

1.3 (FBD) (51 kW | 1.3 Liter)

09.83 → 01.87	JPC		X10-729-002-005	SWP-M-C	T1: 9
09.83 → 01.87	JPC		X10-729-002-008	SWP-M-C	T1: 12

1.4 (51 kW | 1.4 Liter)

09.83 → 01.87	FUBA		X10-729-002-005	SWP-M-C	T1: 9
09.83 → 01.87	FUBA		X10-729-002-008	SWP-M-C	T1: 12

1.4 (FBD) (52 kW | 1.4 Liter)

10.86 → 02.89	F6A / F6C		X10-729-002-005	SWP-M-C	T1: 9
10.86 → 02.89	F6A / F6C		X10-729-002-008	SWP-M-C	T1: 12

1.4 (FBD) (54 kW | 1.4 Liter)

02.87 → 02.89	FUD		X10-729-002-005	SWP-M-C	T1: 9
02.87 → 02.89	FUD		X10-729-002-008	SWP-M-C	T1: 12

1.4 (FBD) (55 kW | 1.4 Liter)

10.85 → 11.89	FUB		X10-729-002-005	SWP-M-C	T1: 9
10.85 → 11.89	FUB		X10-729-002-008	SWP-M-C	T1: 12

1.6 XR2 (FBD) (70 kW | 1.6 Liter)

03.84 → 02.89	LUD		X10-729-002-005	SWP-M-C	T1: 9
03.84 → 02.89	LUD		X10-729-002-008	SWP-M-C	T1: 12

1.6 XR2 (FBD) (71 kW | 1.6 Liter)

04.84 → 02.89	LUB		X10-729-002-005	SWP-M-C	T1: 9
04.84 → 02.89	LUB		X10-729-002-008	SWP-M-C	T1: 12

1.6 D (FBD) (40 kW | 1.6 Liter)

04.84 → 02.89	LTB		X10-729-002-005	SWP-M-C	T1: 9
04.84 → 02.89	LTB		X10-729-002-008	SWP-M-C	T1: 12

FIESTA III (GFJ)**1.0 (33 kW | 1.0 Liter)**

03.89 → 12.95	TLB		X10-729-002-004	SWP-M-C	T1: 9; T7: C →; T8
03.89 → 12.95	TLB		X10-729-002-005	SWP-M-C	T1: 9





1.1 (37 kW | 1.1 Liter)

03.89 → 12.95	G6A		X10-729-002-004	SWP-M-C	T1: 9; T7: C →; T8
03.89 → 12.95	G6A		X10-729-002-005	SWP-M-C	T1: 9

1.1 (40 kW | 1.1 Liter)

03.89 → 12.95	GUD / GUE		X10-729-002-004	SWP-M-C	T1: 9; T7: C →; T8
03.89 → 12.95	GUD / GUE		X10-729-002-005	SWP-M-C	T1: 9



			VDO		
Datum	Motorcode	Fahrgestell Nr.	Artikel Nr.	Artikelbez.	Information

FORD**FIESTA III (GFJ)****1.3 (44 kW | 1.3 Liter)**

03.89 → 12.92	JBC		X10-729-002-004	SWP-M-C	T1: 9; T7: C →; T8
03.89 → 12.92	JBC		X10-729-002-005	SWP-M-C	T1: 9

1.3 KAT (44 kW | 1.3 Liter)

05.91 → 12.95	J6B		X10-729-002-004	SWP-M-C	T1: 9; T7: C →; T8
05.91 → 12.95	J6B		X10-729-002-005	SWP-M-C	T1: 9

1.4 (52 kW | 1.4 Liter)

03.89 → 12.95	F6E		X10-729-002-004	SWP-M-C	T1: 9; T7: C →; T8
03.89 → 12.95	F6E		X10-729-002-005	SWP-M-C	T1: 9

1.4 (54 kW | 1.4 Liter)

03.89 → 12.95	FUG / FUJ		X10-729-002-004	SWP-M-C	T1: 9; T7: C →; T8
03.89 → 12.95	FUG / FUJ		X10-729-002-005	SWP-M-C	T1: 9

1.4 KAT (54 kW | 1.4 Liter)

03.89 → 12.95	F4A		X10-729-002-004	SWP-M-C	T1: 9; T7: C →; T8
03.89 → 12.95	F4A		X10-729-002-005	SWP-M-C	T1: 9

1.6 (65 kW | 1.6 Liter)

01.89 → 01.94	LUH		X10-729-002-004	SWP-M-C	T1: 9; T7: C →; T8
01.89 → 01.94	LUH		X10-729-002-005	SWP-M-C	T1: 9

1.6 i 16V (65 kW | 1.6 Liter)

01.94 → 12.95	L1G		X10-729-002-004	SWP-M-C	T1: 9; T7: C →; T8
01.94 → 12.95	L1G		X10-729-002-005	SWP-M-C	T1: 9

1.6 XR2i (76 kW | 1.6 Liter)

03.89 → 03.93	LJD		X10-729-002-004	SWP-M-C	T1: 9; T7: C →; T8
03.89 → 03.93	LJD		X10-729-002-005	SWP-M-C	T1: 9

1.6 XR2i (81 kW | 1.6 Liter)

03.89 → 01.94	LJC		X10-729-002-004	SWP-M-C	T1: 9; T7: C →; T8
03.89 → 01.94	LJC		X10-729-002-005	SWP-M-C	T1: 9

1.6 Turbo (FBJT) (96 kW | 1.6 Liter)

03.90 → 10.92	LHA		X10-729-002-004	SWP-M-C	T1: 9; T7: C →; T8
03.90 → 10.92	LHA		X10-729-002-005	SWP-M-C	T1: 9

1.8 16V (77 kW | 1.8 Liter)

02.92 → 12.95	RDB		X10-729-002-004	SWP-M-C	T1: 9; T7: C →; T8
02.92 → 12.95	RDB		X10-729-002-005	SWP-M-C	T1: 9

1.8 XR2i 16V (96 kW | 1.8 Liter)

02.92 → 12.95	RQC		X10-729-002-004	SWP-M-C	T1: 9; T7: C →; T8
02.92 → 12.95	RQC		X10-729-002-005	SWP-M-C	T1: 9





1.8 D (44 kW | 1.8 Liter)

03.89 → 12.95	RTC / RTD / RTG		X10-729-002-004	SWP-M-C	T1: 9; T7: C →; T8
03.89 → 12.95	RTC / RTD / RTG		X10-729-002-005	SWP-M-C	T1: 9

1.8 TD (57 kW | 1.8 Liter)

03.93 → 12.95			X10-729-002-004	SWP-M-C	T1: 9; T7: C →; T8
03.93 → 12.95			X10-729-002-005	SWP-M-C	T1: 9



			VDO		
Datum	Motorcode	Fahrgestell Nr.	Artikel Nr.	Artikelbez.	Information

FORD**FIESTA IV (JA_, JB_)**

1.0 i (38 kW 1.0 Liter)					
02.97 → 09.99			X10-729-002-004	SWP-M-C	T1: 9; T7: Focus →>
1.0 i (48 kW 1.0 Liter)					
09.99 → 01.02			X10-729-002-004	SWP-M-C	T1: 9; T7: Focus →>
1.25 i 16V (55 kW 1.25 Liter)					
08.95 → 01.02	DHA / DHB / DHC / DHD / DHE / DHF / DHG		X10-729-002-004	SWP-M-C	T1: 9; T7: Focus →>
1.3 i (37 kW 1.3 Liter)					
08.95 → 01.02	JJA / JJC / JJE / JJJ / JJK / JJM		X10-729-002-004	SWP-M-C	T1: 9; T7: Focus →>
1.3 i (44 kW 1.3 Liter)					
08.95 → 01.02	J4C / J4J / J4L / J4Q / J4R / J4T		X10-729-002-004	SWP-M-C	T1: 9; T7: Focus →>
1.4 i 16V (66 kW 1.4 Liter)					
04.96 → 01.02	FHA / FHE		X10-729-002-004	SWP-M-C	T1: 9; T7: Focus →>
1.6 16V Sport (76 kW 1.6 Liter)					
02.00 → 01.02	L1T / L1V		X10-729-002-004	SWP-M-C	T1: 9; T7: Focus →>
1.8 D (44 kW 1.8 Liter)					
08.95 → 04.00	RTJ / RTK		X10-729-002-004	SWP-M-C	T1: 9; T7: Focus →>
1.8 DI (55 kW 1.8 Liter)					
04.00 → 01.02	RTN / RTP / RTQ		X10-729-002-004	SWP-M-C	T1: 9; T7: Focus →>





FIESTA Courier (F3L, F5L)

1.3 (44 kW 1.3 Liter)					
09.91 → 02.96	J6B		X10-729-002-005	SWP-M-C	T1: 9
1.8 D (44 kW 1.8 Liter)					
09.91 → 02.96	RTC / RTD / RTG		X10-729-002-005	SWP-M-C	T1: 9

FOCUS (DAW, DBW)

1.4 16V (55 kW 1.4 Liter)					
10.98 → 11.04	FXDA / FXDB / FXDC / FXDD		X10-729-002-004	SWP-M-C	T1: 9
1.6 16V (74 kW 1.6 Liter)					
10.98 → 11.04	FYDA / FYDB / FYDC / FYDD		X10-729-002-004	SWP-M-C	T1: 9
1.8 16V (85 kW 1.8 Liter)					
10.98 → 11.04	EYDB / EYDC / EYDD / EYDE / EYDF		X10-729-002-004	SWP-M-C	T1: 9
2.0 16V (96 kW 2.0 Liter)					
10.98 → 11.04	EDDB / EDDC / EDDD / EDDF		X10-729-002-004	SWP-M-C	T1: 9
ST170 (127 kW 2.0 Liter)					
03.02 → 11.04			X10-729-002-004	SWP-M-C	T1: 9
RS (158 kW 2.0 Liter)					
10.02 → 11.04			X10-729-002-004	SWP-M-C	T1: 9
1.8 DI / TDDi (55 kW 1.8 Liter)					
08.99 → 11.04	BHDA / BHDB		X10-729-002-004	SWP-M-C	T1: 9



			VDO		
Datum	Motorcode	Fahrgestell Nr.	Artikel Nr.	Artikelbez.	Information

FORD**FOCUS (DAW, DBW)****1.8 Turbo DI / TDDi (66 kW | 1.8 Liter)**

10.98 → 11.04	C9DA / C9DB / C9DC		X10-729-002-004	SWP-M-C	T1: 9
---------------	--------------------	--	-----------------	---------	-------

1.8 TDCi (74 kW | 1.8 Liter)

09.02 → 11.04	FFDA		X10-729-002-004	SWP-M-C	T1: 9
---------------	------	--	-----------------	---------	-------

1.8 TDCi (85 kW | 1.8 Liter)

03.01 → 11.04	F9DA / F9DB		X10-729-002-004	SWP-M-C	T1: 9
---------------	-------------	--	-----------------	---------	-------

FOCUS Stufenheck (DFW)**1.4 16V (55 kW | 1.4 Liter)**

02.99 → 11.04	FXDA / FXDB / FXDC / FXDD		X10-729-002-004	SWP-M-C	T1: 9; T7: Ambiente →
---------------	---------------------------	--	-----------------	---------	-----------------------

1.6 16V (74 kW | 1.6 Liter)

02.99 → 11.04	FYDA / FYDB / FYDC / FYDD		X10-729-002-004	SWP-M-C	T1: 9; T7: Ambiente →
---------------	---------------------------	--	-----------------	---------	-----------------------

1.8 16V (85 kW | 1.8 Liter)

02.99 → 11.04	EYDB / EYDC / EYDD / EYDE / EYDF		X10-729-002-004	SWP-M-C	T1: 9; T7: Ambiente →
---------------	----------------------------------	--	-----------------	---------	-----------------------

2.0 16V (96 kW | 2.0 Liter)

02.99 → 11.04	EDDB / EDDC / EDDD / EDDF		X10-729-002-004	SWP-M-C	T1: 9; T7: Ambiente →
---------------	---------------------------	--	-----------------	---------	-----------------------

1.8 Turbo DI / TDDi (66 kW | 1.8 Liter)

02.99 → 11.04	C9DA / C9DB / C9DC		X10-729-002-004	SWP-M-C	T1: 9; T7: Ambiente →
---------------	--------------------	--	-----------------	---------	-----------------------

1.8 TDCi (74 kW | 1.8 Liter)

09.02 → 11.04	FFDA		X10-729-002-004	SWP-M-C	T1: 9; T7: Ambiente →
---------------	------	--	-----------------	---------	-----------------------

1.8 TDCi (85 kW | 1.8 Liter)

03.01 → 11.04	F9DA / F9DB		X10-729-002-004	SWP-M-C	T1: 9; T7: Ambiente →
---------------	-------------	--	-----------------	---------	-----------------------

FOCUS Kombi (DNW)**1.4 16V (55 kW | 1.4 Liter)**

02.99 → 11.04	FXDA / FXDB / FXDC / FXDD		X10-729-002-004	SWP-M-C	T1: 9; T7: Ghia →
---------------	---------------------------	--	-----------------	---------	-------------------

1.6 16V (74 kW | 1.6 Liter)

02.99 → 11.04	FYDA / FYDB / FYDC / FYDD		X10-729-002-004	SWP-M-C	T1: 9; T7: Ghia →
---------------	---------------------------	--	-----------------	---------	-------------------

1.8 16V (85 kW | 1.8 Liter)

02.99 → 11.04	EYDB / EYDC / EYDD / EYDE / EYDF		X10-729-002-004	SWP-M-C	T1: 9; T7: Ghia →
---------------	----------------------------------	--	-----------------	---------	-------------------

2.0 16V (96 kW | 2.0 Liter)

02.99 → 11.04	EDDB / EDDC / EDDD / EDDF		X10-729-002-004	SWP-M-C	T1: 9; T7: Ghia →
---------------	---------------------------	--	-----------------	---------	-------------------

ST170 (127 kW | 2.0 Liter)

09.02 → 11.04			X10-729-002-004	SWP-M-C	T1: 9; T7: Ghia →
---------------	--	--	-----------------	---------	-------------------

1.8 DI / TDDi (55 kW | 1.8 Liter)

08.99 → 11.04	BHDA / BHDB		X10-729-002-004	SWP-M-C	T1: 9; T7: Ghia →
---------------	-------------	--	-----------------	---------	-------------------

1.8 Turbo DI / TDDi (66 kW | 1.8 Liter)

02.99 → 11.04	C9DA / C9DB / C9DC		X10-729-002-004	SWP-M-C	T1: 9; T7: Ghia →
---------------	--------------------	--	-----------------	---------	-------------------

1.8 TDCi (74 kW | 1.8 Liter)

09.02 → 11.04	FFDA		X10-729-002-004	SWP-M-C	T1: 9; T7: Ghia →
---------------	------	--	-----------------	---------	-------------------



			VDO		
Datum	Motorcode	Fahrgestell Nr.	Artikel Nr.	Artikelbez.	Information

FORD**FOCUS Kombi (DNW)****1.8 TDCi (85 kW | 1.8 Liter)**

03.01 → 11.04	F9DA / F9DB		X10-729-002-004	SWP-M-C	T1: 9; T7: Ghia →
---------------	-------------	--	-----------------	---------	-------------------

GALAXY (WGR)**2.0 i (85 kW | 2.0 Liter)**

11.95 →	NSE / ZVSA		246-083-002-014G	SWP-D-C	T1: 6
---------	------------	--	------------------	---------	-------

2.3 16V (107 kW | 2.3 Liter)

01.97 →	E55A / Y5B		246-083-002-014G	SWP-D-C	T1: 6
---------	------------	--	------------------	---------	-------

2.8 i V6 (128 kW | 2.8 Liter)

11.95 → 04.00	AAA / AMY		246-083-002-014G	SWP-D-C	T1: 6
---------------	-----------	--	------------------	---------	-------

2.8 i V6 4x4 (128 kW | 2.8 Liter)

04.96 → 04.00	AAA / AMY		246-083-002-014G	SWP-D-C	T1: 6
---------------	-----------	--	------------------	---------	-------

2.8 V6 (150 kW | 2.8 Liter)

04.00 →	AYL		246-083-002-014G	SWP-D-C	T1: 6
---------	-----	--	------------------	---------	-------

1.9 TDI (66 kW | 1.9 Liter)

03.95 →	1Z / AHU / ANU		246-083-002-014G	SWP-D-C	T1: 6
---------	----------------	--	------------------	---------	-------

1.9 TDI (81 kW | 1.9 Liter)

08.97 → 04.00	AFN / AVG		246-083-002-014G	SWP-D-C	T1: 6
---------------	-----------	--	------------------	---------	-------

1.9 TDI (85 kW | 1.9 Liter)

04.00 →	AUY		246-083-002-014G	SWP-D-C	T1: 6
---------	-----	--	------------------	---------	-------

KA (RB_)**1.0 i (38 kW | 1.0 Liter)**

07.97 → 09.99			X10-729-002-004	SWP-M-C	T1: 9
---------------	--	--	-----------------	---------	-------

1.0 i (48 kW | 1.0 Liter)

09.99 →			X10-729-002-004	SWP-M-C	T1: 9
---------	--	--	-----------------	---------	-------

1.3 i (36 kW | 1.3 Liter)

06.98 →	JJD / JJF / JJG / JJH / JJJ		X10-729-002-004	SWP-M-C	T1: 9
---------	-----------------------------	--	-----------------	---------	-------

1.3 i (37 kW | 1.3 Liter)

09.96 →	JJB		X10-729-002-004	SWP-M-C	T1: 9
---------	-----	--	-----------------	---------	-------

1.3 i (44 kW | 1.3 Liter)

09.96 →	BAA / J4D / J4K / J4M / J4N / J4P / J4S		X10-729-002-004	SWP-M-C	T1: 9
---------	-----------------------------------------	--	-----------------	---------	-------

STREET KA**1.6 (70 kW | 1.6 Liter)**

05.03 → 07.05	CDRA / CDRB		X10-729-002-005	SWP-M-C	T1: 9
---------------	-------------	--	-----------------	---------	-------

MONDEO I (GBP)**1.6 i 16V (65 kW | 1.6 Liter)**

07.94 → 08.96	L1J		X10-729-002-004	SWP-M-C	T1: 9; T7: CLX →
---------------	-----	--	-----------------	---------	------------------



			VDO		
Datum	Motorcode	Fahrgestell Nr.	Artikel Nr.	Artikelbez.	Information

FORD**MONDEO I (GBP)**

1.6 i 16V (66 kW 1.6 Liter)					
02.93 → 08.96	L1F		X10-729-002-004	SWP-M-C	T1: 9; T7: CLX →
1.8 i 16V (82 kW 1.8 Liter)					
07.94 → 08.96	RKB		X10-729-002-004	SWP-M-C	T1: 9; T7: CLX →
1.8 i 16V (85 kW 1.8 Liter)					
02.93 → 08.96	RKA		X10-729-002-004	SWP-M-C	T1: 9; T7: CLX →
1.8 i 16V 4x4 (85 kW 1.8 Liter)					
02.93 → 08.96	RKA		X10-729-002-004	SWP-M-C	T1: 9; T7: CLX →
2.0 i 16V (97 kW 2.0 Liter)					
12.94 → 08.96			X10-729-002-004	SWP-M-C	T1: 9; T7: CLX →
2.0 i 16V 4x4 (97 kW 2.0 Liter)					
12.94 → 08.96	NGA		X10-729-002-004	SWP-M-C	T1: 9; T7: CLX →
2.0 i 16V (100 kW 2.0 Liter)					
02.93 → 08.96	NGA		X10-729-002-004	SWP-M-C	T1: 9; T7: CLX →
2.5 i 24V (125 kW 2.5 Liter)					
07.94 → 08.96	SEA		X10-729-002-004	SWP-M-C	T1: 9; T7: CLX →
1.8 TD (65 kW 1.8 Liter)					
06.93 → 08.96	RFM / RFN		X10-729-002-004	SWP-M-C	T1: 9; T7: CLX →
1.8 TD (66 kW 1.8 Liter)					
10.95 → 08.96	RFM / RFN		X10-729-002-004	SWP-M-C	T1: 9; T7: CLX →

MONDEO I Kombi (BNP)

1.6 i 16V (65 kW 1.6 Liter)					
07.94 → 08.96	L1J		X10-729-002-004	SWP-M-C	T1: 9; T7: CLX →
1.6 i 16V (66 kW 1.6 Liter)					
04.93 → 08.96	L1F		X10-729-002-004	SWP-M-C	T1: 9; T7: CLX →
1.8 i 16V (82 kW 1.8 Liter)					
07.94 → 08.96	RKB		X10-729-002-004	SWP-M-C	T1: 9; T7: CLX →
1.8 i 16V (85 kW 1.8 Liter)					
04.93 → 08.96	RKA		X10-729-002-004	SWP-M-C	T1: 9; T7: CLX →
1.8 i 16V 4x4 (85 kW 1.8 Liter)					
04.93 → 08.96	RKA		X10-729-002-004	SWP-M-C	T1: 9; T7: CLX →
2.0 i 16V (97 kW 2.0 Liter)					
01.93 → 08.96			X10-729-002-004	SWP-M-C	T1: 9; T7: CLX →
2.0 i 16V 4x4 (97 kW 2.0 Liter)					
12.94 → 08.96			X10-729-002-004	SWP-M-C	T1: 9; T7: CLX →
2.0 i 16V (100 kW 2.0 Liter)					
04.93 → 08.96	NGA		X10-729-002-004	SWP-M-C	T1: 9; T7: CLX →
2.0 i 16V 4x4 (100 kW 2.0 Liter)					
04.93 → 08.96	NGA		X10-729-002-004	SWP-M-C	T1: 9; T7: CLX →
2.5 i 24V (125 kW 2.5 Liter)					
07.94 → 08.96	SEA		X10-729-002-004	SWP-M-C	T1: 9; T7: CLX →
1.8 TD (65 kW 1.8 Liter)					
06.93 → 08.96	RFM / RFN		X10-729-002-004	SWP-M-C	T1: 9; T7: CLX →



			VDO		
Datum	Motorcode	Fahrgestell Nr.	Artikel Nr.	Artikelbez.	Information

FORD**MONDEO I Kombi (BNP)****1.8 TD (66 kW | 1.8 Liter)**

11.95 → 08.96	RFM / RFN		X10-729-002-004	SWP-M-C	T1: 9; T7: CLX →
---------------	-----------	--	-----------------	---------	------------------

MONDEO II (BAP)**1.6 i (66 kW | 1.6 Liter)**

09.96 → 11.00	L1J		X10-729-002-004	SWP-M-C	T1: 9; T7: CLX →; T8
09.96 → 11.00	L1J		X10-729-002-005	SWP-M-C	T1: 9; T7: CLX →

1.6 i 16V (70 kW | 1.6 Liter)

05.98 → 11.00	L1L / L1N / L1Q		X10-729-002-004	SWP-M-C	T1: 9; T7: CLX →; T8
05.98 → 11.00	L1L / L1N / L1Q		X10-729-002-005	SWP-M-C	T1: 9; T7: CLX →

1.8 i (85 kW | 1.8 Liter)

09.96 → 11.00	RKB / RKF / RKH / RKJ / RKK		X10-729-002-004	SWP-M-C	T1: 9; T7: CLX →; T8
09.96 → 11.00	RKB / RKF / RKH / RKJ / RKK		X10-729-002-005	SWP-M-C	T1: 9; T7: CLX →

2.0 i (96 kW | 2.0 Liter)

09.96 → 11.00	NGA / NGB / NGC / NGD		X10-729-002-004	SWP-M-C	T1: 9; T7: CLX →; T8
09.96 → 11.00	NGA / NGB / NGC / NGD		X10-729-002-005	SWP-M-C	T1: 9; T7: CLX →

2.5 24V (125 kW | 2.5 Liter)

06.00 → 11.00			X10-729-002-004	SWP-M-C	T1: 9; T7: CLX →; T8
06.00 → 11.00			X10-729-002-005	SWP-M-C	T1: 9; T7: CLX →

2.5 24V (125 kW | 2.5 Liter)

09.96 → 11.00	SEA		X10-729-002-004	SWP-M-C	T1: 9; T7: CLX →; T8
09.96 → 11.00	SEA		X10-729-002-005	SWP-M-C	T1: 9; T7: CLX →

2.5 ST 200 (151 kW | 2.5 Liter)

05.99 → 11.00	SGA		X10-729-002-004	SWP-M-C	T1: 9; T7: CLX →; T8
05.99 → 11.00	SGA		X10-729-002-005	SWP-M-C	T1: 9; T7: CLX →

1.8 TD (66 kW | 1.8 Liter)

09.96 → 11.00	RFN		X10-729-002-004	SWP-M-C	T1: 9; T7: CLX →; T8
09.96 → 11.00	RFN		X10-729-002-005	SWP-M-C	T1: 9; T7: CLX →

MONDEO II Stufenheck (BFP)**1.6 i (66 kW | 1.6 Liter)**

09.96 → 11.00	L1J		X10-729-002-005	SWP-M-C	T1: 9
---------------	-----	--	-----------------	---------	-------

1.6 i 16V (70 kW | 1.6 Liter)

05.98 → 11.00	L1L / L1N / L1Q		X10-729-002-005	SWP-M-C	T1: 9
---------------	-----------------	--	-----------------	---------	-------

1.8 i (85 kW | 1.8 Liter)

09.96 → 11.00	RKB / RKF / RKH / RKJ / RKK		X10-729-002-005	SWP-M-C	T1: 9
---------------	-----------------------------	--	-----------------	---------	-------

2.0 i (96 kW | 2.0 Liter)

09.96 → 11.00	NGA / NGB / NGC / NGD		X10-729-002-005	SWP-M-C	T1: 9
---------------	-----------------------	--	-----------------	---------	-------





2.5 24V (125 kW | 2.5 Liter)

06.00 → 11.00			X10-729-002-005	SWP-M-C	T1: 9
---------------	--	--	-----------------	---------	-------

2.5 24V (125 kW | 2.5 Liter)

09.96 → 11.00	SEA		X10-729-002-005	SWP-M-C	T1: 9
---------------	-----	--	-----------------	---------	-------



			VDO		
Datum	Motorcode	Fahrgestell Nr.	Artikel Nr.	Artikelbez.	Information

FORD**MONDEO II Stufenheck (BFP)****2.5 ST 200 (151 kW | 2.5 Liter)**

05.99 → 11.00	SGA		X10-729-002-005	SWP-M-C	T1: 9
---------------	-----	--	-----------------	---------	-------

1.8 TD (66 kW | 1.8 Liter)

09.96 → 11.00	RFN		X10-729-002-005	SWP-M-C	T1: 9
---------------	-----	--	-----------------	---------	-------

MONDEO II Kombi (BNP)**1.6 i (66 kW | 1.6 Liter)**

09.96 → 11.00	L1J		X10-729-002-004	SWP-M-C	T1: 9; T7: CLX →>; T9
---------------	-----	--	-----------------	---------	-----------------------

09.96 → 11.00	L1J		X10-729-002-005	SWP-M-C	T1: 9; T7: CLX →>
---------------	-----	--	-----------------	---------	-------------------

1.6 i 16V (70 kW | 1.6 Liter)

05.98 → 11.00	L1L / L1N / L1Q		X10-729-002-004	SWP-M-C	T1: 9; T7: CLX →>; T9
---------------	-----------------	--	-----------------	---------	-----------------------

05.98 → 11.00	L1L / L1N / L1Q		X10-729-002-005	SWP-M-C	T1: 9; T7: CLX →>
---------------	-----------------	--	-----------------	---------	-------------------

1.8 i (85 kW | 1.8 Liter)

09.96 → 11.00	RKB / RKF / RKH / RKJ / RKK		X10-729-002-004	SWP-M-C	T1: 9; T7: CLX →>; T9
---------------	-----------------------------	--	-----------------	---------	-----------------------

09.96 → 11.00	RKB / RKF / RKH / RKJ / RKK		X10-729-002-005	SWP-M-C	T1: 9; T7: CLX →>
---------------	-----------------------------	--	-----------------	---------	-------------------

2.0 i (96 kW | 2.0 Liter)

09.96 → 11.00	NGA / NGB / NGC / NGD		X10-729-002-004	SWP-M-C	T1: 9; T7: CLX →>; T9
---------------	-----------------------	--	-----------------	---------	-----------------------

09.96 → 11.00	NGA / NGB / NGC / NGD		X10-729-002-005	SWP-M-C	T1: 9; T7: CLX →>
---------------	-----------------------	--	-----------------	---------	-------------------

2.5 24V (125 kW | 2.5 Liter)

06.00 → 11.00			X10-729-002-004	SWP-M-C	T1: 9; T7: CLX →>; T9
---------------	--	--	-----------------	---------	-----------------------

06.00 → 11.00			X10-729-002-005	SWP-M-C	T1: 9; T7: CLX →>
---------------	--	--	-----------------	---------	-------------------

2.5 24V (125 kW | 2.5 Liter)

09.96 → 11.00	SEA		X10-729-002-004	SWP-M-C	T1: 9; T7: CLX →>; T9
---------------	-----	--	-----------------	---------	-----------------------

09.96 → 11.00	SEA		X10-729-002-005	SWP-M-C	T1: 9; T7: CLX →>
---------------	-----	--	-----------------	---------	-------------------

2.5 ST 200 (151 kW | 2.5 Liter)

05.99 → 11.00	SGA		X10-729-002-004	SWP-M-C	T1: 9; T7: CLX →>; T9
---------------	-----	--	-----------------	---------	-----------------------

05.99 → 11.00	SGA		X10-729-002-005	SWP-M-C	T1: 9; T7: CLX →>
---------------	-----	--	-----------------	---------	-------------------

1.8 TD (66 kW | 1.8 Liter)

09.96 → 11.00	RFN		X10-729-002-004	SWP-M-C	T1: 9; T7: CLX →>; T9
---------------	-----	--	-----------------	---------	-----------------------

09.96 → 11.00	RFN		X10-729-002-005	SWP-M-C	T1: 9; T7: CLX →>
---------------	-----	--	-----------------	---------	-------------------

ORION II (AFF)**1.3 (44 kW | 1.3 Liter)**

09.88 → 07.90	JBB / JLA / JLB		X10-729-002-005	SWP-M-C	T1: 9
---------------	-----------------	--	-----------------	---------	-------

1.4 (52 kW | 1.4 Liter)

09.88 → 07.90			X10-729-002-005	SWP-M-C	T1: 9
---------------	--	--	-----------------	---------	-------

1.4 (54 kW | 1.4 Liter)

09.88 → 07.90	FUC		X10-729-002-005	SWP-M-C	T1: 9
---------------	-----	--	-----------------	---------	-------

1.4 KAT (54 kW | 1.4 Liter)

09.88 → 07.90	F6B / F6D		X10-729-002-005	SWP-M-C	T1: 9
---------------	-----------	--	-----------------	---------	-------

1.4 (55 kW | 1.4 Liter)

09.88 → 07.90	FUA		X10-729-002-005	SWP-M-C	T1: 9
---------------	-----	--	-----------------	---------	-------



			VDO		
Datum	Motorcode	Fahrgestell Nr.	Artikel Nr.	Artikelbez.	Information

FORD**ORION II (AFF)**

1.6 (66 kW 1.6 Liter)					
09.88 → 07.90	LUC		X10-729-002-005	SWP-M-C	T1: 9
1.6 i KAT (66 kW 1.6 Liter)					
09.88 → 07.90	L4B		X10-729-002-005	SWP-M-C	T1: 9
1.6 i (75 kW 1.6 Liter)					
08.89 → 07.90	LJB		X10-729-002-005	SWP-M-C	T1: 9
1.6 i (77 kW 1.6 Liter)					
09.88 → 07.90	LRB		X10-729-002-005	SWP-M-C	T1: 9
1.6 D (40 kW 1.6 Liter)					
09.88 → 01.89	LTC		X10-729-002-005	SWP-M-C	T1: 9
1.8 D (44 kW 1.8 Liter)					
01.89 → 07.90	RTA / RTB		X10-729-002-005	SWP-M-C	T1: 9





ORION III (GAL)

1.3 (44 kW 1.3 Liter)					
07.90 → 12.93	J4B / J6A		X10-729-002-005	SWP-M-C	T1: 9
1.4 (52 kW 1.4 Liter)					
07.90 → 12.93	F6F / F6G		X10-729-002-005	SWP-M-C	T1: 9
1.4 (54 kW 1.4 Liter)					
07.90 → 12.93	FUH		X10-729-002-005	SWP-M-C	T1: 9
1.6 i 16V (66 kW 1.6 Liter)					
07.92 → 12.93	L1E / L1K		X10-729-002-005	SWP-M-C	T1: 9
1.6 (66 kW 1.6 Liter)					
07.90 → 12.92	LUJ / LUK		X10-729-002-005	SWP-M-C	T1: 9
1.6 i (77 kW 1.6 Liter)					
07.90 → 09.92	LJF		X10-729-002-005	SWP-M-C	T1: 9
1.8 i 16V (77 kW 1.8 Liter)					
02.92 → 12.93	RDA		X10-729-002-005	SWP-M-C	T1: 9
1.8 i 16V (96 kW 1.8 Liter)					
01.92 → 12.93	RQB		X10-729-002-005	SWP-M-C	T1: 9
1.8 D (44 kW 1.8 Liter)					
11.90 → 12.93	RTE / RTF / RTH		X10-729-002-005	SWP-M-C	T1: 9
1.8 TD (66 kW 1.8 Liter)					
03.92 → 12.93	RFD / RFK		X10-729-002-005	SWP-M-C	T1: 9

PUMA (EC_)

1.4 16V (66 kW 1.4 Liter)					
11.97 → 10.00	FHD / FHF		X10-729-002-004	SWP-M-C	T1: 9
1.6 16V (76 kW 1.6 Liter)					
08.00 →	L1W		X10-729-002-004	SWP-M-C	T1: 9
1.7 16V (92 kW 1.7 Liter)					
03.97 →	MHA / MHB		X10-729-002-004	SWP-M-C	T1: 9



			VDO		
Datum	Motorcode	Fahrgestell Nr.	Artikel Nr.	Artikelbez.	Information

FORD**PUMA (EC_)****ST 160 (118 kW | 1.7 Liter)**

06.99 →			X10-729-002-004	SWP-M-C	T1: 9
---------	--	--	-----------------	---------	-------

SCORPIO I (GAE, GGE)**1.8 (66 kW | 1.8 Liter)**

04.85 → 02.92	REC		X10-729-002-008	SWP-M-C	T1: 12
---------------	-----	--	-----------------	---------	--------

2.0 i (74 kW | 2.0 Liter)

10.85 → 12.90	NRC		X10-729-002-008	SWP-M-C	T1: 12
---------------	-----	--	-----------------	---------	--------

2.0 (77 kW | 2.0 Liter)

04.85 → 08.89	N8D / NEL		X10-729-002-008	SWP-M-C	T1: 12
---------------	-----------	--	-----------------	---------	--------

2.0 (80 kW | 2.0 Liter)

01.92 → 10.92			X10-729-002-005	SWP-M-C	T1: 9
---------------	--	--	-----------------	---------	-------

2.0 i (85 kW | 2.0 Liter)

04.85 → 02.92	NRA / NRI		X10-729-002-008	SWP-M-C	T1: 12
---------------	-----------	--	-----------------	---------	--------

2.0 i (85 kW | 2.0 Liter)

02.92 → 09.94	NRA / NRI		X10-729-002-008	SWP-M-C	T1: 12
---------------	-----------	--	-----------------	---------	--------

2.0 i (88 kW | 2.0 Liter)

05.89 → 09.94	N9D		X10-729-002-008	SWP-M-C	T1: 12
---------------	-----	--	-----------------	---------	--------

2.4 i (92 kW | 2.4 Liter)

10.88 → 02.92	ARD		X10-729-002-008	SWP-M-C	T1: 12
---------------	-----	--	-----------------	---------	--------

2.4 i KAT (92 kW | 2.4 Liter)

10.88 → 09.94	ARD		X10-729-002-008	SWP-M-C	T1: 12
---------------	-----	--	-----------------	---------	--------

2.4 i (96 kW | 2.4 Liter)

09.86 → 09.88	ARC		X10-729-002-008	SWP-M-C	T1: 12
---------------	-----	--	-----------------	---------	--------

2.8 i (110 kW | 2.8 Liter)

04.85 → 11.86	PRE		X10-729-002-008	SWP-M-C	T1: 12
---------------	-----	--	-----------------	---------	--------

2.8 i 4x4 (110 kW | 2.8 Liter)

10.85 → 11.86	PRE		X10-729-002-008	SWP-M-C	T1: 12
---------------	-----	--	-----------------	---------	--------

2.9 i (107 kW | 2.9 Liter)

09.86 → 09.94	BRD / BRE / BRF		X10-729-002-008	SWP-M-C	T1: 12
---------------	-----------------	--	-----------------	---------	--------

2.9 i KAT (107 kW | 2.9 Liter)

10.87 → 09.94	BRE		X10-729-002-008	SWP-M-C	T1: 12
---------------	-----	--	-----------------	---------	--------

2.9 i 4x4 (107 kW | 2.9 Liter)

05.88 → 02.93	BRD / BRE / BRF		X10-729-002-008	SWP-M-C	T1: 12
---------------	-----------------	--	-----------------	---------	--------

2.9 i (110 kW | 2.9 Liter)

09.86 → 09.94	BRC		X10-729-002-008	SWP-M-C	T1: 12
---------------	-----	--	-----------------	---------	--------

2.9 i 4x4 (110 kW | 2.9 Liter)

09.86 → 09.94	BRC		X10-729-002-008	SWP-M-C	T1: 12
---------------	-----	--	-----------------	---------	--------

2.9 i 24V (143 kW | 2.9 Liter)

04.91 → 09.94	BOA		X10-729-002-008	SWP-M-C	T1: 12
---------------	-----	--	-----------------	---------	--------

2.5 D (51 kW | 2.5 Liter)

12.85 → 02.92	STR		X10-729-002-008	SWP-M-C	T1: 12
---------------	-----	--	-----------------	---------	--------

2.5 TD (68 kW | 2.5 Liter)

06.88 → 07.93	SFA / SFB		X10-729-002-008	SWP-M-C	T1: 12
---------------	-----------	--	-----------------	---------	--------



			VDO		
Datum	Motorcode	Fahrgestell Nr.	Artikel Nr.	Artikelbez.	Information

FORD**SCORPIO I (GAE, GGE)****2.5 TD (85 kW | 2.5 Liter)**

08.93 → 09.94	SCB		X10-729-002-008	SWP-M-C	T1: 12
---------------	-----	--	-----------------	---------	--------

SCORPIO I Stufenheck (GGE)**2.0 i (85 kW | 2.0 Liter)**

02.92 → 09.94	N9F		X10-729-002-005	SWP-M-C	T1: 9
---------------	-----	--	-----------------	---------	-------

2.0 i (88 kW | 2.0 Liter)

01.92 → 09.94	N9D		X10-729-002-005	SWP-M-C	T1: 9
---------------	-----	--	-----------------	---------	-------

2.0 i (92 kW | 2.0 Liter)

01.92 → 02.92			X10-729-002-005	SWP-M-C	T1: 9
---------------	--	--	-----------------	---------	-------

2.4 i (92 kW | 2.4 Liter)

01.92 → 10.94	ARD		X10-729-002-005	SWP-M-C	T1: 9
---------------	-----	--	-----------------	---------	-------

2.9 i (107 kW | 2.9 Liter)

01.92 → 12.94	BRD / BRE / BRF		X10-729-002-005	SWP-M-C	T1: 9
---------------	-----------------	--	-----------------	---------	-------

2.9 i 4x4 (107 kW | 2.9 Liter)

01.92 → 10.94	BRD / BRE / BRF		X10-729-002-005	SWP-M-C	T1: 9
---------------	-----------------	--	-----------------	---------	-------

2.9 i 24V (143 kW | 2.9 Liter)

01.92 → 09.94	BOA		X10-729-002-005	SWP-M-C	T1: 9
---------------	-----	--	-----------------	---------	-------

2.5 D (51 kW | 2.5 Liter)

01.92 → 12.94			X10-729-002-005	SWP-M-C	T1: 9
---------------	--	--	-----------------	---------	-------

2.5 TD (68 kW | 2.5 Liter)

01.92 → 07.93	SFA / SFB		X10-729-002-005	SWP-M-C	T1: 9
---------------	-----------	--	-----------------	---------	-------

2.5 TD (85 kW | 2.5 Liter)

08.93 → 09.94	SCB		X10-729-002-005	SWP-M-C	T1: 9
---------------	-----	--	-----------------	---------	-------

SCORPIO I Kombi (GGE)**2.0 i (85 kW | 2.0 Liter)**

02.92 → 04.94	N9F		X10-729-002-004	SWP-M-C	T1: 9; T7: CLX →
---------------	-----	--	-----------------	---------	------------------

2.0 i (88 kW | 2.0 Liter)

02.92 → 04.94	N9D		X10-729-002-004	SWP-M-C	T1: 9; T7: CLX →
---------------	-----	--	-----------------	---------	------------------

2.4 i (92 kW | 2.4 Liter)

02.92 → 04.94	ARD		X10-729-002-004	SWP-M-C	T1: 9; T7: CLX →
---------------	-----	--	-----------------	---------	------------------

2.9 i (107 kW | 2.9 Liter)

02.92 → 04.94	BRD / BRE / BRF		X10-729-002-004	SWP-M-C	T1: 9; T7: CLX →
---------------	-----------------	--	-----------------	---------	------------------

2.9 i 4x4 (107 kW | 2.9 Liter)

02.92 → 02.93	BRD / BRE / BRF		X10-729-002-004	SWP-M-C	T1: 9; T7: CLX →
---------------	-----------------	--	-----------------	---------	------------------

2.9 24V (143 kW | 2.9 Liter)

08.93 → 04.94	BOA		X10-729-002-004	SWP-M-C	T1: 9; T7: CLX →
---------------	-----	--	-----------------	---------	------------------

2.5 TD (68 kW | 2.5 Liter)

02.92 → 07.93	SFA / SFB		X10-729-002-004	SWP-M-C	T1: 9; T7: CLX →
---------------	-----------	--	-----------------	---------	------------------

2.5 TD (85 kW | 2.5 Liter)

08.93 → 04.94	SCB		X10-729-002-004	SWP-M-C	T1: 9; T7: CLX →
---------------	-----	--	-----------------	---------	------------------



			VDO		
Datum	Motorcode	Fahrgestell Nr.	Artikel Nr.	Artikelbez.	Information

FORD**SCORPIO II (GFR, GGR)**

2.0 i (85 kW 2.0 Liter)					
10.94 → 08.98	NSD		X10-729-002-005	SWP-M-C	T1: 9
2.0 i 16V (100 kW 2.0 Liter)					
10.94 → 08.98	N3A		X10-729-002-005	SWP-M-C	T1: 9
2.3 i 16V (108 kW 2.3 Liter)					
06.96 → 08.98	Y5A		X10-729-002-005	SWP-M-C	T1: 9
2.9 i (110 kW 2.9 Liter)					
02.95 → 08.98	BRG		X10-729-002-005	SWP-M-C	T1: 9
2.9 i 24V (152 kW 2.9 Liter)					
10.94 → 08.98	BOB		X10-729-002-005	SWP-M-C	T1: 9
2.5 TD (85 kW 2.5 Liter)					
10.94 → 08.98	SCC		X10-729-002-005	SWP-M-C	T1: 9
2.5 TD (92 kW 2.5 Liter)					
09.96 → 08.98	VM		X10-729-002-005	SWP-M-C	T1: 9

SCORPIO II Kombi (GNR, GGR)

2.0 i (85 kW 2.0 Liter)					
10.94 → 08.98	NSD		X10-729-002-005	SWP-M-C	T1: 9
2.0 i 16V (100 kW 2.0 Liter)					
10.94 → 08.98	N3A		X10-729-002-005	SWP-M-C	T1: 9
2.3 i 16V (108 kW 2.3 Liter)					
06.96 → 08.98	Y5A		X10-729-002-005	SWP-M-C	T1: 9
2.9 i (110 kW 2.9 Liter)					
02.95 → 08.98	BRG		X10-729-002-005	SWP-M-C	T1: 9
2.9 i 24V (152 kW 2.9 Liter)					
10.94 → 08.98	BOB		X10-729-002-005	SWP-M-C	T1: 9
2.5 TD (85 kW 2.5 Liter)					
10.94 → 08.98	SCC		X10-729-002-005	SWP-M-C	T1: 9
2.5 TD (92 kW 2.5 Liter)					
09.96 → 08.98	VM		X10-729-002-005	SWP-M-C	T1: 9

SIERRA Schrägheck (GBC)

1.3 (44 kW 1.3 Liter)					
08.82 → 12.86	JCT		X10-729-002-008	SWP-M-C	T1: 12
1.6 (55 kW 1.6 Liter)					
08.82 → 12.86	LCS / LCT / LSD		X10-729-002-008	SWP-M-C	T1: 12
1.6 (58 kW 1.6 Liter)					
08.84 → 12.86			X10-729-002-008	SWP-M-C	T1: 12
1.8 (66 kW 1.8 Liter)					
10.84 → 12.86	REB		X10-729-002-008	SWP-M-C	T1: 12
2.0 (66 kW 2.0 Liter)					
08.82 → 10.84	NYT		X10-729-002-008	SWP-M-C	T1: 12



			VDO		
Datum	Motorcode	Fahrgestell Nr.	Artikel Nr.	Artikelbez.	Information

FORD**SIERRA Schrägheck (GBC)**

2.0 (74 kW 2.0 Liter)					
10.85 → 12.86	NRD		X10-729-002-008	SWP-M-C	T1: 12
2.0 (77 kW 2.0 Liter)					
08.82 → 12.86	NET		X10-729-002-008	SWP-M-C	T1: 12
2.0 i (85 kW 2.0 Liter)					
03.85 → 12.86	NR2 / NRB		X10-729-002-008	SWP-M-C	T1: 12
2.3 (84 kW 2.3 Liter)					
08.82 → 12.86	YYT		X10-729-002-008	SWP-M-C	T1: 12
2.8 XR4i (105 kW 2.8 Liter)					
08.82 → 12.86	PR6		X10-729-002-008	SWP-M-C	T1: 12
2.8 XR4i (107 kW 2.8 Liter)					
08.82 → 12.86	PR5		X10-729-002-008	SWP-M-C	T1: 12
2.8 i XR 4x4 (107 kW 2.8 Liter)					
09.83 → 12.86			X10-729-002-008	SWP-M-C	T1: 12
2.8 XR4i (110 kW 2.8 Liter)					
08.82 → 12.86	PRT		X10-729-002-008	SWP-M-C	T1: 12
2.8 XR 4x4 (110 kW 2.8 Liter)					
02.85 → 12.86	PRT		X10-729-002-008	SWP-M-C	T1: 12
2.3 D (49 kW 2.3 Liter)					
08.82 → 12.86	YTT		X10-729-002-008	SWP-M-C	T1: 12

SIERRA Schrägheck (GBC, GBG)

1.6 (53 kW 1.6 Liter)					
01.88 → 02.93	LSF		X10-729-002-008	SWP-M-C	T1: 12; T8
1.6 (55 kW 1.6 Liter)					
01.87 → 02.93	LSE		X10-729-002-008	SWP-M-C	T1: 12; T8
1.6 i (59 kW 1.6 Liter)					
10.89 → 02.93	L6B		X10-729-002-008	SWP-M-C	T1: 12; T8
1.8 (59 kW 1.8 Liter)					
10.87 → 05.88	RED / REF		X10-729-002-008	SWP-M-C	T1: 12; T8
1.8 (64 kW 1.8 Liter)					
05.88 → 02.93	R2C / R6A		X10-729-002-008	SWP-M-C	T1: 12; T8
1.8 (66 kW 1.8 Liter)					
01.87 → 05.88	R2A / RED		X10-729-002-008	SWP-M-C	T1: 12; T8
2.0 i (74 kW 2.0 Liter)					
01.87 → 02.93	NE5 / NEJ		X10-729-002-008	SWP-M-C	T1: 12; T8
2.0 i KAT (74 kW 2.0 Liter)					
01.87 → 02.93	N4B		X10-729-002-008	SWP-M-C	T1: 12; T8
2.0 (77 kW 2.0 Liter)					
01.87 → 02.93	N8C / NES		X10-729-002-008	SWP-M-C	T1: 12; T8
2.0 i (80 kW 2.0 Liter)					
06.89 → 02.93	N8A		X10-729-002-008	SWP-M-C	T1: 12; T8
2.0 i (85 kW 2.0 Liter)					
01.87 → 02.93	N4A / N4I		X10-729-002-008	SWP-M-C	T1: 12; T8



			VDO		
Datum	Motorcode	Fahrgestell Nr.	Artikel Nr.	Artikelbez.	Information

FORD**SIERRA Schrägheck (GBC, GBG)**

2.0 i (88 kW 2.0 Liter)					
06.89 → 02.93	N9C		X10-729-002-008	SWP-M-C	T1: 12; T8
2.0 i (92 kW 2.0 Liter)					
06.89 → 02.93	N9B		X10-729-002-008	SWP-M-C	T1: 12; T8
2.0 RS Cosworth (150 kW 2.0 Liter)					
11.87 → 01.90	N5B		X10-729-002-008	SWP-M-C	T1: 12; T8
2.0 16V Cosworth 4x4 (162 kW 2.0 Liter)					
01.90 → 02.93	N5D		X10-729-002-008	SWP-M-C	T1: 12; T8
2.0 16V Cosworth 4x4 KAT (162 kW 2.0 Liter)					
01.90 → 02.93	N5C		X10-729-002-008	SWP-M-C	T1: 12; T8
2.8 i (105 kW 2.8 Liter)					
01.87 → 02.93	PR8		X10-729-002-008	SWP-M-C	T1: 12; T8
2.8 i XR 4x4 (107 kW 2.8 Liter)					
01.87 → 02.93	PR7		X10-729-002-008	SWP-M-C	T1: 12; T8
2.8 i XR 4x4 (110 kW 2.8 Liter)					
01.87 → 08.88	PRG		X10-729-002-008	SWP-M-C	T1: 12; T8
2.9 i (107 kW 2.9 Liter)					
08.88 → 02.93	B4B / B4C		X10-729-002-008	SWP-M-C	T1: 12; T8
2.9 i XR 4x4 (107 kW 2.9 Liter)					
08.88 → 02.93	B4B / B4C		X10-729-002-008	SWP-M-C	T1: 12; T8
2.9 i XR 4x4 (110 kW 2.9 Liter)					
08.88 → 02.93	B4A		X10-729-002-008	SWP-M-C	T1: 12; T8
1.8 TD (55 kW 1.8 Liter)					
08.88 → 02.93	RFA / RFB / RFL		X10-729-002-008	SWP-M-C	T1: 12; T8
2.3 D (49 kW 2.3 Liter)					
01.87 → 09.89	YTR		X10-729-002-008	SWP-M-C	T1: 12; T8

SIERRA (GBG, GB4)

1.6 (53 kW 1.6 Liter)					
01.88 → 02.93	LSF	...HD; ...HE; ...HL	X10-729-002-005	SWP-M-C	T1: 9
1.6 (55 kW 1.6 Liter)					
03.87 → 02.93	LSE	...HD; ...HE; ...HL	X10-729-002-005	SWP-M-C	T1: 9
1.6 i (59 kW 1.6 Liter)					
10.89 → 02.93	L6B	...HD; ...HE; ...HL	X10-729-002-005	SWP-M-C	T1: 9
1.8 (64 kW 1.8 Liter)					
05.88 → 02.93	R2C / R6A	...HD; ...HE; ...HL	X10-729-002-005	SWP-M-C	T1: 9
1.8 (59 kW 1.8 Liter)					
10.87 → 09.89	RED / REF	...HD; ...HE; ...HL	X10-729-002-005	SWP-M-C	T1: 9
1.8 (66 kW 1.8 Liter)					
03.87 → 05.88	R2A / RED	...HD; ...HE; ...HL	X10-729-002-005	SWP-M-C	T1: 9
2.0 i (74 kW 2.0 Liter)					
03.87 → 12.89	NE5 / NEJ	...HD; ...HE; ...HL	X10-729-002-005	SWP-M-C	T1: 9
2.0 i KAT (74 kW 2.0 Liter)					
03.87 → 02.93	N4B	...HD; ...HE; ...HL	X10-729-002-005	SWP-M-C	T1: 9



			VDO		
Datum	Motorcode	Fahrgestell Nr.	Artikel Nr.	Artikelbez.	Information

FORD**SIERRA (GBG, GB4)**

2.0 (77 kW 2.0 Liter)					
03.87 → 02.93	N8C / NES	...HD; ...HE; ...HL	X10-729-002-005	SWP-M-C	T1: 9
2.0 i (85 kW 2.0 Liter)					
03.87 → 02.93	N4A / N4I	...HD; ...HE; ...HL	X10-729-002-005	SWP-M-C	T1: 9
2.0 i (88 kW 2.0 Liter)					
01.90 → 02.93	N9C	...HD; ...HE; ...HL	X10-729-002-005	SWP-M-C	T1: 9
2.0 4x4 (88 kW 2.0 Liter)					
01.90 → 02.93	N9C	...HD; ...HE; ...HL	X10-729-002-005	SWP-M-C	T1: 9
2.0 i (92 kW 2.0 Liter)					
01.90 → 02.93	N9C	...HD; ...HE; ...HL	X10-729-002-005	SWP-M-C	T1: 9
2.0 4x4 (92 kW 2.0 Liter)					
01.90 → 02.93	N9C	...HD; ...HE; ...HL	X10-729-002-005	SWP-M-C	T1: 9
2.8 i (105 kW 2.8 Liter)					
08.87 → 02.93	PR8	...HD; ...HE; ...HL	X10-729-002-005	SWP-M-C	T1: 9
2.9 i (107 kW 2.9 Liter)					
08.88 → 02.93	B4B / B4C	...HD; ...HE; ...HL	X10-729-002-005	SWP-M-C	T1: 9
2.9 4x4 (107 kW 2.9 Liter)					
08.88 → 02.93	B4B / B4C	...HD; ...HE; ...HL	X10-729-002-005	SWP-M-C	T1: 9
2.9 i (110 kW 2.9 Liter)					
08.88 → 02.93	B4B / B4C	...HD; ...HE; ...HL	X10-729-002-005	SWP-M-C	T1: 9
2.9 4x4 (110 kW 2.9 Liter)					
08.88 → 02.93	B4B / B4C	...HD; ...HE; ...HL	X10-729-002-005	SWP-M-C	T1: 9
1.8 TD (55 kW 1.8 Liter)					
08.88 → 02.93	RFA / RFB / RFL	...HD; ...HE; ...HL	X10-729-002-005	SWP-M-C	T1: 9
2.3 D (49 kW 2.3 Liter)					
03.87 → 09.89	YTR / YTT	...HD; ...HE; ...HL	X10-729-002-005	SWP-M-C	T1: 9

SIERRA Kombi (BNG)

1.6 (53 kW 1.6 Liter)					
01.88 → 02.93	LSF	...HD; ...HE; ...HL	X10-729-002-005	SWP-M-C	T1: 9
1.6 (55 kW 1.6 Liter)					
03.87 → 02.93	LSE	...HD; ...HE; ...HL	X10-729-002-005	SWP-M-C	T1: 9
1.6 i (59 kW 1.6 Liter)					
10.89 → 02.93	L6B	...HD; ...HE; ...HL	X10-729-002-005	SWP-M-C	T1: 9
1.8 (59 kW 1.8 Liter)					
10.87 → 05.88	RED / REF	...HD; ...HE; ...HL	X10-729-002-005	SWP-M-C	T1: 9
1.8 (64 kW 1.8 Liter)					
05.88 → 02.93	R2C / R6A	...HD; ...HE; ...HL	X10-729-002-005	SWP-M-C	T1: 9
1.8 (66 kW 1.8 Liter)					
03.87 → 05.88	R2A / RED	...HD; ...HE; ...HL	X10-729-002-005	SWP-M-C	T1: 9
2.0 i (74 kW 2.0 Liter)					
03.87 → 02.93	NE5 / NEJ	...HD; ...HE; ...HL	X10-729-002-005	SWP-M-C	T1: 9
2.0 i KAT (74 kW 2.0 Liter)					
03.87 → 02.93	N4B	...HD; ...HE; ...HL	X10-729-002-005	SWP-M-C	T1: 9



			VDO		
Datum	Motorcode	Fahrgestell Nr.	Artikel Nr.	Artikelbez.	Information

FORD**SIERRA Kombi (BNG)**

2.0 (77 kW 2.0 Liter)					
03.87 → 02.93	N8C / NES	...HD; ...HE; ...HL	X10-729-002-005	SWP-M-C	T1: 9
2.0 i (85 kW 2.0 Liter)					
03.87 → 02.93	N4A / N4I	...HD; ...HE; ...HL	X10-729-002-005	SWP-M-C	T1: 9
2.0 i (88 kW 2.0 Liter)					
05.89 → 02.93	N9C	...HD; ...HE; ...HL	X10-729-002-005	SWP-M-C	T1: 9
2.0 4x4 (88 kW 2.0 Liter)					
02.90 → 02.93	N9C	...HD; ...HE; ...HL	X10-729-002-005	SWP-M-C	T1: 9
2.0 i (92 kW 2.0 Liter)					
05.89 → 02.93	N9C	...HD; ...HE; ...HL	X10-729-002-005	SWP-M-C	T1: 9
2.0 4x4 (92 kW 2.0 Liter)					
05.89 → 02.93	N9C	...HD; ...HE; ...HL	X10-729-002-005	SWP-M-C	T1: 9
2.8 i (105 kW 2.8 Liter)					
03.87 → 02.93	PR8	...HD; ...HE; ...HL	X10-729-002-005	SWP-M-C	T1: 9
2.8 i (107 kW 2.8 Liter)					
03.87 → 02.93	PR7	...HD; ...HE; ...HL	X10-729-002-005	SWP-M-C	T1: 9
2.8 i 4x4 (107 kW 2.8 Liter)					
03.87 → 02.93	PR7	...HD; ...HE; ...HL	X10-729-002-005	SWP-M-C	T1: 9
2.8 4x4 (110 kW 2.8 Liter)					
03.87 → 08.88	PRG	...HD; ...HE; ...HL	X10-729-002-005	SWP-M-C	T1: 9
2.9 (107 kW 2.9 Liter)					
08.88 → 02.93	B4B / B4C	...HD; ...HE; ...HL	X10-729-002-005	SWP-M-C	T1: 9
2.9 4x4 (107 kW 2.9 Liter)					
08.88 → 02.93	B4B / B4C	...HD; ...HE; ...HL	X10-729-002-005	SWP-M-C	T1: 9
2.9 i (110 kW 2.9 Liter)					
08.88 → 02.93	B4B / B4C	...HD; ...HE; ...HL	X10-729-002-005	SWP-M-C	T1: 9
2.9 4x4 (110 kW 2.9 Liter)					
08.88 → 02.93	B4B / B4C	...HD; ...HE; ...HL	X10-729-002-005	SWP-M-C	T1: 9
1.8 TD (55 kW 1.8 Liter)					
08.88 → 02.93	RFA / RFB / RFL	...HD; ...HE; ...HL	X10-729-002-005	SWP-M-C	T1: 9
2.3 D (49 kW 2.3 Liter)					
03.87 → 02.93	YTR	...HD; ...HE; ...HL	X10-729-002-005	SWP-M-C	T1: 9

TRANSIT Pritsche/Fahrgestell (V_ _)

1.6 (VCS, VDS) (48 kW 1.6 Liter)					
11.85 → 10.86	B		X10-729-002-008	SWP-M-C	T1: 12
2.0 (VGL, VSL, VTL, VCS, VDS) (57 kW 2.0 Liter)					
11.85 → 10.86	4RC		X10-729-002-008	SWP-M-C	T1: 12
2.5 D (VGL, VSL, VTL, VCS, VDS) (50 kW 2.5 Liter)					
11.85 → 10.86	4AB		X10-729-002-008	SWP-M-C	T1: 12



			VDO		
Datum	Motorcode	Fahrgestell Nr.	Artikel Nr.	Artikelbez.	Information

FORD**TRANSIT Bus (V_)****1.6 (VAS, VLS, VZS) (48 kW | 1.6 Liter)**

11.85 → 10.86	4RB		X10-729-002-008	SWP-M-C	T1: 12
---------------	-----	--	-----------------	---------	--------

2.0 (VAS, VLS, VZS) (55 kW | 2.0 Liter)

11.85 → 10.86	4RC		X10-729-002-008	SWP-M-C	T1: 12
---------------	-----	--	-----------------	---------	--------

2.0 (VAS, VIL, VLS, VUL, VZS) (57 kW | 2.0 Liter)

11.85 → 10.86	4RC		X10-729-002-008	SWP-M-C	T1: 12
---------------	-----	--	-----------------	---------	--------

2.4 D (VAS, VBL, VIL, VUL, VZS) (46 kW | 2.4 Liter)

11.85 → 10.86	4AA		X10-729-002-008	SWP-M-C	T1: 12
---------------	-----	--	-----------------	---------	--------

2.5 D (VAS, VBL, VIL, VUL, VZS) (50 kW | 2.5 Liter)

11.85 → 10.86	4AB		X10-729-002-008	SWP-M-C	T1: 12
---------------	-----	--	-----------------	---------	--------

TRANSIT Kasten (V_)**1.6 (WS) (48 kW | 1.6 Liter)**

11.85 → 10.86	4RB		X10-729-002-008	SWP-M-C	T1: 12
---------------	-----	--	-----------------	---------	--------

2.0 (VVL) (55 kW | 2.0 Liter)

11.85 → 10.86	4RC		X10-729-002-008	SWP-M-C	T1: 12
---------------	-----	--	-----------------	---------	--------

2.0 (VHL, VVS) (57 kW | 2.0 Liter)

11.85 → 10.86	4RC		X10-729-002-008	SWP-M-C	T1: 12
---------------	-----	--	-----------------	---------	--------

2.4 D (VVS) (46 kW | 2.4 Liter)

11.85 → 10.86	4AA		X10-729-002-008	SWP-M-C	T1: 12
---------------	-----	--	-----------------	---------	--------

2.5 D (VVL) (50 kW | 2.5 Liter)

11.85 → 10.86	4AB		X10-729-002-008	SWP-M-C	T1: 12
---------------	-----	--	-----------------	---------	--------

TRANSIT Bus (T_)**1.6 (TBL, TES) (46 kW | 1.6 Liter)**

12.85 → 01.89	LAT		246-082-008-014C	SWP-M-C	T1: 1; T4
---------------	-----	--	------------------	---------	-----------

12.85 → 01.89	LAT		X10-729-002-008	SWP-M-C	T1: 12
---------------	-----	--	-----------------	---------	--------

2.0 (TBS, TCL, TCS, TEL, TES) (57 kW | 2.0 Liter)

11.85 → 09.92	NAT / NAV		246-082-008-014C	SWP-M-C	T1: 1; T4
---------------	-----------	--	------------------	---------	-----------

11.85 → 09.92	NAT / NAV		X10-729-002-008	SWP-M-C	T1: 12
---------------	-----------	--	-----------------	---------	--------

2.0 (TBS, TCL, TCS) KAT (57 kW | 2.0 Liter)

12.85 → 09.92	N6T		246-082-008-014C	SWP-M-C	T1: 1; T4
---------------	-----	--	------------------	---------	-----------

12.85 → 09.92	N6T		X10-729-002-008	SWP-M-C	T1: 12
---------------	-----	--	-----------------	---------	--------

2.5 D (TBS, TCL, TCS, TEL, TES) (50 kW | 2.5 Liter)

12.85 → 01.89	4AB		246-082-008-014C	SWP-M-C	T1: 1; T4
---------------	-----	--	------------------	---------	-----------

12.85 → 01.89	4AB		X10-729-002-008	SWP-M-C	T1: 12
---------------	-----	--	-----------------	---------	--------

2.5 D (TBS, TEL, TES) (52 kW | 2.5 Liter)

09.88 → 09.92	4BA / 4CA		246-082-008-014C	SWP-M-C	T1: 1; T4
---------------	-----------	--	------------------	---------	-----------

09.88 → 09.92	4BA / 4CA		X10-729-002-008	SWP-M-C	T1: 12
---------------	-----------	--	-----------------	---------	--------



			VDO		
Datum	Motorcode	Fahrgestell Nr.	Artikel Nr.	Artikelbez.	Information

FORD**TRANSIT Kasten (T_)****1.6 (TAS) (46 kW | 1.6 Liter)**

09.85 → 09.92	LAT		246-082-008-014C	SWP-M-C	T1: 1; T4
09.85 → 09.92	LAT		X10-729-002-008	SWP-M-C	T1: 12

2.0 (TAL, TAS, TGL, TWS) (57 kW | 2.0 Liter)

09.85 → 09.92	NAT / NAV		246-082-008-014C	SWP-M-C	T1: 1; T4
09.85 → 09.92	NAT / NAV		X10-729-002-008	SWP-M-C	T1: 12

2.5 D (TAL, TAS, TGL, TWS) (50 kW | 2.5 Liter)

01.86 → 09.91	4AB		246-082-008-014C	SWP-M-C	T1: 1; T4
01.86 → 09.91	4AB		X10-729-002-008	SWP-M-C	T1: 12

2.5 D (TAL, TAS, TGL, TWS) (52 kW | 2.5 Liter)

10.88 → 09.91	4BA / 4CA		246-082-008-014C	SWP-M-C	T1: 1; T4
10.88 → 09.91	4BA / 4CA		X10-729-002-008	SWP-M-C	T1: 12

TRANSIT Pritsche/Fahrgestell (T_)**2.0 (TTE, TTL, TTS) (57 kW | 2.0 Liter)**

01.86 → 09.92	NAT / NAV		X10-729-002-008	SWP-M-C	T1: 12
---------------	-----------	--	-----------------	---------	--------

2.0 (TUL) KAT (57 kW | 2.0 Liter)

11.85 → 09.92	N6T		X10-729-002-008	SWP-M-C	T1: 12
---------------	-----	--	-----------------	---------	--------

2.5 D (TTL, TTS, TUL, TUS, TTE) KAT (50 kW | 2.5 Liter)

01.86 → 01.89	4AB		X10-729-002-008	SWP-M-C	T1: 12
---------------	-----	--	-----------------	---------	--------

2.5 DI (TTE, TTL, TTS, TUL) (52 kW | 2.5 Liter)

09.88 → 09.92	4BA / 4CA		X10-729-002-008	SWP-M-C	T1: 12
---------------	-----------	--	-----------------	---------	--------

TRANSIT Bus (E_)**2.0 (66 kW | 2.0 Liter)**

09.91 → 09.94	NBA		X10-729-002-008	SWP-M-C	T1: 12
---------------	-----	--	-----------------	---------	--------

2.0 i (EBL, EDL, EGL, ESS, EUS) (72 kW | 2.0 Liter)

09.91 → 07.94	NCA		X10-729-002-008	SWP-M-C	T1: 12
---------------	-----	--	-----------------	---------	--------

2.9 i (107 kW | 2.9 Liter)

01.91 →	BRT		X10-729-002-008	SWP-M-C	T1: 12
---------	-----	--	-----------------	---------	--------

2.5 DI (EBS, EDS, EDL, ESS, EUS) (51 kW | 2.5 Liter)

08.91 → 07.94	4BC / 4CC / 4FA		X10-729-002-008	SWP-M-C	T1: 12
---------------	-----------------	--	-----------------	---------	--------

2.5 DI (EBS, EDS, EGL, ESS, EUS) (59 kW | 2.5 Liter)

09.91 → 07.94	4DA		X10-729-002-008	SWP-M-C	T1: 12
---------------	-----	--	-----------------	---------	--------

2.5 TD (EBS, EBL, ECL, EDS, EDL, ESS, EUS) (63 kW | 2.5 Liter)

10.92 → 07.94	4GA / 4GB / 4GC		X10-729-002-008	SWP-M-C	T1: 12
---------------	-----------------	--	-----------------	---------	--------

2.5 TD (ECL, EDS, EDL, EGL, ESS, EUS) (74 kW | 2.5 Liter)

09.91 → 07.94	4EA		X10-729-002-008	SWP-M-C	T1: 12
---------------	-----	--	-----------------	---------	--------



			VDO		
Datum	Motorcode	Fahrgestell Nr.	Artikel Nr.	Artikelbez.	Information

FORD**TRANSIT Kasten (E_ _)****2.0 (66 kW | 2.0 Liter)**

09.91 → 06.94	NBA		246-082-008-014C	SWP-M-C	T1: 1; T4
09.91 → 06.94	NBA		X10-729-002-008	SWP-M-C	T1: 12

2.0 i (EAL, EAS) (72 kW | 2.0 Liter)

09.91 → 06.94	NCA		246-082-008-014C	SWP-M-C	T1: 1; T4
09.91 → 06.94	NCA		X10-729-002-008	SWP-M-C	T1: 12

2.5 DI (EAL, EAS) (51 kW | 2.5 Liter)

05.91 → 06.94	4BC / 4CC / 4FA		246-082-008-014C	SWP-M-C	T1: 1; T4
05.91 → 06.94	4BC / 4CC / 4FA		X10-729-002-008	SWP-M-C	T1: 12

2.5 DI (EAS, EAL) (59 kW | 2.5 Liter)

05.91 → 06.94	4DA		246-082-008-014C	SWP-M-C	T1: 1; T4
05.91 → 06.94	4DA		X10-729-002-008	SWP-M-C	T1: 12

2.5 DI (EAL, EAS) (63 kW | 2.5 Liter)

10.92 → 06.94	4GA		246-082-008-014C	SWP-M-C	T1: 1; T4
10.92 → 06.94	4GA		X10-729-002-008	SWP-M-C	T1: 12

2.5 TD (EAS, EAL) (74 kW | 2.5 Liter)

05.91 → 06.94	4EA		246-082-008-014C	SWP-M-C	T1: 1; T4
05.91 → 06.94	4EA		X10-729-002-008	SWP-M-C	T1: 12

TRANSIT Pritsche/Fahrgestell (E_ _)**2.0 (EME/L/S, ENE/L/S) (72 kW | 2.0 Liter)**

09.91 → 08.94	NCA		X10-729-002-008	SWP-M-C	T1: 12
---------------	-----	--	-----------------	---------	--------

2.5 DI (EML/S, ENL/S) (51 kW | 2.5 Liter)

09.91 → 08.94	4BC / 4CC / 4FA		X10-729-002-008	SWP-M-C	T1: 12
---------------	-----------------	--	-----------------	---------	--------

2.5 DI (EME/L/S, ENE/L/S) (59 kW | 2.5 Liter)

09.91 → 08.94	4DA		X10-729-002-008	SWP-M-C	T1: 12
---------------	-----	--	-----------------	---------	--------

2.5 TD (EME/L/S, ENE/L/S) (63 kW | 2.5 Liter)

11.92 → 08.94	4GA		X10-729-002-008	SWP-M-C	T1: 12
---------------	-----	--	-----------------	---------	--------

2.5 TD (EME/L/S, ENE/L) (74 kW | 2.5 Liter)

09.91 → 08.94	4EA		X10-729-002-008	SWP-M-C	T1: 12
---------------	-----	--	-----------------	---------	--------

TRANSIT Bus (E_ _)**2.0 (EBL, EBS, ECL, EDS, EDL, EGL, ESS, ESL, EUS) (84 kW | 2.0 Liter)**

09.95 → 03.00	NSF / NSG		X10-729-002-008	SWP-M-C	T1: 12
---------------	-----------	--	-----------------	---------	--------

2.0 CNG (84 kW | 2.0 Liter)

06.94 → 03.00	NSH		X10-729-002-008	SWP-M-C	T1: 12
---------------	-----	--	-----------------	---------	--------

2.5 DI (EBL, EDS, ESL, ESS, EUS) (51 kW | 2.5 Liter)

08.94 → 03.00	4FA / 4FB / 4FC / 4FD		X10-729-002-008	SWP-M-C	T1: 12
---------------	-----------------------	--	-----------------	---------	--------

2.5 TD (EB_ , ED_ , ES_) (55 kW | 2.5 Liter)

08.94 → 06.00	4HA / 4HD		X10-729-002-008	SWP-M-C	T1: 12
---------------	-----------	--	-----------------	---------	--------

2.5 DI (EBL, ECL, EDS, EDL) (56 kW | 2.5 Liter)

07.94 → 03.00	4HB / 4HC		X10-729-002-008	SWP-M-C	T1: 12
---------------	-----------	--	-----------------	---------	--------



			VDO		
Datum	Motorcode	Fahrgestell Nr.	Artikel Nr.	Artikelbez.	Information

FORD**TRANSIT Bus (E_ _)****2.5 TD (EBL, EDL, EDS, EGL, ESL, ESS, EUS) (63 kW | 2.5 Liter)**

01.95 → 03.00	4GA / 4GB / 4GC / 4GD / 4GE / 4GF		X10-729-002-008	SWP-M-C	T1: 12
---------------	--------------------------------------	--	-----------------	---------	--------

2.5 TD (ECL, EDL, EDS, ESL, ESS, EUS) (74 kW | 2.5 Liter)

07.94 → 03.00	4EB / 4EC		X10-729-002-008	SWP-M-C	T1: 12
---------------	-----------	--	-----------------	---------	--------

2.5 DI (EBL, EDL, EDS, ESL, ESS) (85 kW | 2.5 Liter)

08.97 → 03.00	4ED		X10-729-002-008	SWP-M-C	T1: 12
---------------	-----	--	-----------------	---------	--------

TRANSIT Kasten (E_ _)**2.0 (EAL, EAS) (84 kW | 2.0 Liter)**

06.94 → 03.00	NSF / NSG		246-082-008-014C	SWP-M-C	T1: 1; T4
06.94 → 03.00	NSF / NSG		X10-729-002-008	SWP-M-C	T1: 12

2.5 DI (EAL, EAS) (51 kW | 2.5 Liter)

06.94 → 03.00	4FA / 4FB / 4FC / 4FD		246-082-008-014C	SWP-M-C	T1: 1; T4
06.94 → 03.00	4FA / 4FB / 4FC / 4FD		X10-729-002-008	SWP-M-C	T1: 12

2.5 TD (EAS) (55 kW | 2.5 Liter)

10.98 → 03.00	4HA / 4HD		246-082-008-014C	SWP-M-C	T1: 1; T4
10.98 → 03.00	4HA / 4HD		X10-729-002-008	SWP-M-C	T1: 12

2.5 DI (EAL, EAS) (56 kW | 2.5 Liter)

06.94 → 03.00	4HB / 4HC		246-082-008-014C	SWP-M-C	T1: 1; T4
06.94 → 03.00	4HB / 4HC		X10-729-002-008	SWP-M-C	T1: 12

2.5 TD (EAL, EAS) (63 kW | 2.5 Liter)

06.94 → 03.00	4GA / 4GB / 4GC / 4GD / 4GE / 4GF		246-082-008-014C	SWP-M-C	T1: 1; T4
06.94 → 03.00	4GA / 4GB / 4GC / 4GD / 4GE / 4GF		X10-729-002-008	SWP-M-C	T1: 12

2.5 TDI (EAL, EAS) (74 kW | 2.5 Liter)

06.94 → 03.00	4EB / 4EC		246-082-008-014C	SWP-M-C	T1: 1; T4
06.94 → 03.00	4EB / 4EC		X10-729-002-008	SWP-M-C	T1: 12

2.5 DI (EAL, EAS) (85 kW | 2.5 Liter)

05.99 → 03.00	4ED		246-082-008-014C	SWP-M-C	T1: 1; T4
05.99 → 03.00	4ED		X10-729-002-008	SWP-M-C	T1: 12

TRANSIT Pritsche/Fahrgestell (E_ _)**2.0 (EME/L/S, ENE/L/S) (84 kW | 2.0 Liter)**

08.94 → 03.00	NSF / NSG		X10-729-002-008	SWP-M-C	T1: 12
---------------	-----------	--	-----------------	---------	--------

2.5 DI (EML/S, ENL/S) (51 kW | 2.5 Liter)

08.94 → 03.00	4FA / 4FB / 4FC / 4FD		X10-729-002-008	SWP-M-C	T1: 12
---------------	-----------------------	--	-----------------	---------	--------

2.5 TD (EME/L/S, ENE/L/S) (55 kW | 2.5 Liter)

10.98 →	4HA / 4HD		X10-729-002-008	SWP-M-C	T1: 12
---------	-----------	--	-----------------	---------	--------

2.5 DI (EME/L/S, ENE/L/S) (56 kW | 2.5 Liter)

08.94 → 03.00	4HB / 4HC		X10-729-002-008	SWP-M-C	T1: 12
---------------	-----------	--	-----------------	---------	--------



			VDO		
Datum	Motorcode	Fahrgestell Nr.	Artikel Nr.	Artikelbez.	Information

FORD**TRANSIT Pritsche/Fahrgestell (E_ _)****2.5 TD (EME/L/S, ENE/L/S) (63 kW | 2.5 Liter)**

08.94 → 03.00	4GA / 4GB / 4GC / 4GD / 4GE / 4GF		X10-729-002-008	SWP-M-C	T1: 12
---------------	-----------------------------------	--	-----------------	---------	--------

2.5 TD (EME/L/S, ENE/L/S) (74 kW | 2.5 Liter)

08.94 → 03.00	4EB / 4EC		X10-729-002-008	SWP-M-C	T1: 12
---------------	-----------	--	-----------------	---------	--------

2.5 DI (EML, ENE/L) (85 kW | 2.5 Liter)

05.99 → 03.00	4ED		X10-729-002-008	SWP-M-C	T1: 12
---------------	-----	--	-----------------	---------	--------

TRANSIT Bus (FD_ _ , FB_ _ , FS_ _ , FZ_ _ , FC_ _)**2.3 16V (F_B_ , F_C_ , F_A_) (107 kW | 2.3 Liter)**

04.01 →	E5FA		X10-729-002-005	SWP-M-C	T1: 9
---------	------	--	-----------------	---------	-------

2.0 DI (F_E_ , F_F_ , F_G_) (55 kW | 2.0 Liter)

08.00 →	D3FA		X10-729-002-005	SWP-M-C	T1: 9
---------	------	--	-----------------	---------	-------

2.0 DI (F_E_ , F_F_ , F_G_) (63 kW | 2.0 Liter)

08.00 →			X10-729-002-005	SWP-M-C	T1: 9
---------	--	--	-----------------	---------	-------

2.0 DI (F_E_ , F_F_ , F_G_) (74 kW | 2.0 Liter)

08.00 →	ABFA		X10-729-002-005	SWP-M-C	T1: 9
---------	------	--	-----------------	---------	-------

2.0 TDCi (F_F_ , F_E_ , F_G_) (92 kW | 2.0 Liter)

08.02 →			X10-729-002-005	SWP-M-C	T1: 9
---------	--	--	-----------------	---------	-------

2.4 DI (F_B_ , F_C_) (55 kW | 2.4 Liter)

01.00 →	F4FA		X10-729-002-005	SWP-M-C	T1: 9
---------	------	--	-----------------	---------	-------

2.4 DI (F_B_ , F_C_ , F_A_) (66 kW | 2.4 Liter)

01.00 →	D2FA / D2FE		X10-729-002-005	SWP-M-C	T1: 9
---------	-------------	--	-----------------	---------	-------

2.4 TDE (85 kW | 2.4 Liter)

03.04 →			X10-729-002-005	SWP-M-C	T1: 9
---------	--	--	-----------------	---------	-------

2.4 DI (F_B_ , F_C_ , F_A_) (88 kW | 2.4 Liter)

01.00 →	D4FA		X10-729-002-005	SWP-M-C	T1: 9
---------	------	--	-----------------	---------	-------

2.4 TDE (F_C_ , F_B_ , F_A_) (92 kW | 2.4 Liter)

07.01 →			X10-729-002-005	SWP-M-C	T1: 9
---------	--	--	-----------------	---------	-------

2.4 TDCi (101 kW | 2.4 Liter)

03.04 →			X10-729-002-005	SWP-M-C	T1: 9
---------	--	--	-----------------	---------	-------

TRANSIT Kasten (FA_ _)**2.3 16V (FAA_ , FAB_ , FAC_) (107 kW | 2.3 Liter)**

04.01 →	E5FA		X10-729-002-004	SWP-M-C	T1: 9
---------	------	--	-----------------	---------	-------

2.0 DI (FAE_ , FAF_ , FAG_) (55 kW | 2.0 Liter)

08.00 →	D3FA		X10-729-002-004	SWP-M-C	T1: 9
---------	------	--	-----------------	---------	-------

2.0 DI (FAE_ , FAF_ , FAG_) (63 kW | 2.0 Liter)

08.00 →			X10-729-002-004	SWP-M-C	T1: 9
---------	--	--	-----------------	---------	-------

2.0 DI (FAE_ , FAF_ , FAG_) (74 kW | 2.0 Liter)

08.00 →	ABFA		X10-729-002-004	SWP-M-C	T1: 9
---------	------	--	-----------------	---------	-------

2.0 TDCi (92 kW | 2.0 Liter)

08.02 →			X10-729-002-004	SWP-M-C	T1: 9
---------	--	--	-----------------	---------	-------



			VDO		
Datum	Motorcode	Fahrgestell Nr.	Artikel Nr.	Artikelbez.	Information

FORD**TRANSIT Kasten (FA_ _)****2.4 DI (FAA_ , FAB_ , FAC_ , FAD_) (55 kW | 2.4 Liter)**

01.00 → F4FA X10-729-002-004 SWP-M-C T1: 9

2.4 DI (FAA_ , FAB_ , FAC_ , FAD_) (66 kW | 2.4 Liter)

01.00 → D2FA / D2FE X10-729-002-004 SWP-M-C T1: 9

2.4 TDE (85 kW | 2.4 Liter)

03.04 → X10-729-002-005 SWP-M-C T1: 9

2.4 DI (FAA_ , FAB_ , FAC_ , FAD_) (88 kW | 2.4 Liter)

01.00 → D4FA X10-729-002-004 SWP-M-C T1: 9

2.4 TDE (92 kW | 2.4 Liter)

07.01 → X10-729-002-005 SWP-M-C T1: 9

2.4 TDCi (101 kW | 2.4 Liter)

03.04 → X10-729-002-005 SWP-M-C T1: 9

TRANSIT Pritsche/Fahrgestell (FM_ _ , FN_ _)**2.3 16V (F_A_ , F_B_ , F_C_ , F_D_) (107 kW | 2.3 Liter)**

04.01 → X10-729-002-004 SWP-M-C T1: 9

04.01 → X10-729-002-005 SWP-M-C T1: 9; T6: FT 300 K

2.0 DI (F_E_ , F_F_) (55 kW | 2.0 Liter)

08.00 → D3FA X10-729-002-004 SWP-M-C T1: 9

08.00 → D3FA X10-729-002-005 SWP-M-C T1: 9; T6: FT 300 K

2.0 DI (F_E_ , F_F_) (63 kW | 2.0 Liter)

08.00 → X10-729-002-005 SWP-M-C T1: 9; T6: FT 300 K

2.0 DI (F_E_ , F_F_) (74 kW | 2.0 Liter)

08.00 → ABFA X10-729-002-004 SWP-M-C T1: 9

08.00 → ABFA X10-729-002-005 SWP-M-C T1: 9; T6: FT 300 K

2.0 TDCi (F_E_ , F_F_) (92 kW | 2.0 Liter)

08.02 → X10-729-002-004 SWP-M-C T1: 9

08.02 → X10-729-002-005 SWP-M-C T1: 9; T6: FT 300 K

2.4 DI (F_A_ , F_B_ , F_C_ , F_D_) (55 kW | 2.4 Liter)

01.00 → F4FA X10-729-002-004 SWP-M-C T1: 9

01.00 → F4FA X10-729-002-005 SWP-M-C T1: 9; T6: FT 300 K

2.4 DI (F_A_ , F_B_ , F_C_ , F_D_) (66 kW | 2.4 Liter)

01.00 → D2FA / D2FE X10-729-002-004 SWP-M-C T1: 9

01.00 → D2FA / D2FE X10-729-002-005 SWP-M-C T1: 9; T6: FT 300 K

2.4 TDE (85 kW | 2.4 Liter)

03.04 → X10-729-002-005 SWP-M-C T1: 9

2.4 DI (F_A_ , F_B_ , F_C_ , F_D_) (88 kW | 2.4 Liter)

01.00 → D4FA X10-729-002-004 SWP-M-C T1: 9

01.00 → D4FA X10-729-002-005 SWP-M-C T1: 9; T6: FT 300 K

2.4 TDE (92 kW | 2.4 Liter)

07.01 → X10-729-002-005 SWP-M-C T1: 9

2.4 TDCi (101 kW | 2.4 Liter)

03.04 → X10-729-002-005 SWP-M-C T1: 9



			VDO		
Datum	Motorcode	Fahrgestell Nr.	Artikel Nr.	Artikelbez.	Information

LADA**NIVA (2121)****1700 i (59 kW | 1.7 Liter)**

06.96 →	BA3 21214		246-082-008-014C	SWP-M-C	T1: 1; T3: 89-602-050
---------	-----------	--	------------------	---------	-----------------------

1900 Diesel (47 kW | 1.9 Liter)

02.95 →	XUD9A		246-082-008-014C	SWP-M-C	T1: 1; T3: 89-602-050
---------	-------	--	------------------	---------	-----------------------

SAMARA (2108, 2109)**1100 (39 kW | 1.1 Liter)**

02.88 → 12.94	BA3 21081		246-082-008-014C	SWP-M-C	T1: 1; T3: 89-602-050
---------------	-----------	--	------------------	---------	-----------------------

1100 (43 kW | 1.1 Liter)

02.96 →	BA3 21081 (KAT)		246-082-008-014C	SWP-M-C	T1: 1; T3: 89-602-050
---------	-----------------	--	------------------	---------	-----------------------

1300 (46 kW | 1.3 Liter)

01.88 →			246-082-008-014C	SWP-M-C	T1: 1; T3: 89-602-050
---------	--	--	------------------	---------	-----------------------

1300 (48 kW | 1.3 Liter)

01.86 → 12.94	BA3 2108		246-082-008-014C	SWP-M-C	T1: 1; T3: 89-602-050
---------------	----------	--	------------------	---------	-----------------------

1300 (50 kW | 1.3 Liter)

02.96 →	BA3 21115		246-082-008-014C	SWP-M-C	T1: 1; T3: 89-602-050
---------	-----------	--	------------------	---------	-----------------------

1500 (52 kW | 1.5 Liter)

02.95 →	BA3 2111		246-082-008-014C	SWP-M-C	T1: 1; T3: 89-602-050
---------	----------	--	------------------	---------	-----------------------

SAMARA FORMA (21099)**1100 (39 kW | 1.1 Liter)**

07.91 →	BA3 21081 (KAT)		246-082-008-014C	SWP-M-C	T1: 1; T3: 89-602-050
---------	-----------------	--	------------------	---------	-----------------------

1300 (45 kW | 1.3 Liter)

07.91 →	BA3 2108		246-082-008-014C	SWP-M-C	T1: 1; T3: 89-602-050
---------	----------	--	------------------	---------	-----------------------

1300 (46 kW | 1.3 Liter)

05.90 →			246-082-008-014C	SWP-M-C	T1: 1; T3: 89-602-050
---------	--	--	------------------	---------	-----------------------

1300 (48 kW | 1.3 Liter)

05.89 → 07.97	BA3 2108		246-082-008-014C	SWP-M-C	T1: 1; T3: 89-602-050
---------------	----------	--	------------------	---------	-----------------------

1300 (50 kW | 1.3 Liter)

02.96 →			246-082-008-014C	SWP-M-C	T1: 1; T3: 89-602-050
---------	--	--	------------------	---------	-----------------------

1500 (50 kW | 1.5 Liter)

07.91 →	BA3 21083 (KAT)		246-082-008-014C	SWP-M-C	T1: 1; T3: 89-602-050
---------	-----------------	--	------------------	---------	-----------------------

1500 (52 kW | 1.5 Liter)

11.94 →	BA3 2111		246-082-008-014C	SWP-M-C	T1: 1; T3: 89-602-050
---------	----------	--	------------------	---------	-----------------------

1500 (53 kW | 1.5 Liter)

09.91 →	BA3 21083		246-082-008-014C	SWP-M-C	T1: 1; T3: 89-602-050
---------	-----------	--	------------------	---------	-----------------------



			VDO		
Datum	Motorcode	Fahrgestell Nr.	Artikel Nr.	Artikelbez.	Information





LANCIA**DEDRA (835)**

1.6 i.e. (835AN) (55 kW 1.6 Liter)					
04.93 → 06.94	835 C1.000		246-083-001-004C	SWP-D-C	T1: 1
1.6 i.e. (835AB) (57 kW 1.6 Liter)					
08.89 → 03.93	835 A1.046		246-083-001-004C	SWP-D-C	T1: 1
1.6 i.e. (835AA) (66 kW 1.6 Liter)					
02.92 → 06.94	835 A1.000		246-083-001-004C	SWP-D-C	T1: 1
1.6 LE (835EB) KAT (66 kW 1.6 Liter)					
07.94 → 07.99	159 B9.000		246-083-001-004C	SWP-D-C	T1: 1
1.6 16V (835EI) (76 kW 1.6 Liter)					
01.96 → 07.99	182 A4.000		246-083-001-004C	SWP-D-C	T1: 1
1.8 16V LE (835FG) (83 kW 1.8 Liter)					
03.96 → 07.99	182 A2.000		246-083-001-004C	SWP-D-C	T1: 1
1.8 GT 16V (835EH) (96 kW 1.8 Liter)					
03.96 → 07.99	183 A1.000		246-083-001-004C	SWP-D-C	T1: 1
1.8 i.e. (835AT) (66 kW 1.8 Liter)					
08.93 → 07.99	835 C5.000		246-083-001-004C	SWP-D-C	T1: 1
1.8 i.e. (835FA) (74 kW 1.8 Liter)					
07.94 → 07.99	836 A5.000		246-083-001-004C	SWP-D-C	T1: 1
1.8 i.e. (835BD, 835AD) (77 kW 1.8 Liter)					
09.89 → 07.99	835 A2.046		246-083-001-004C	SWP-D-C	T1: 1
1.8 i.e. (835AC, 835BC) (80 kW 1.8 Liter)					
09.89 → 06.94	835 A2.000		246-083-001-004C	SWP-D-C	T1: 1
2.0 i.e. (835AL) (83 kW 2.0 Liter)					
09.89 → 07.99	835 A5.046		246-083-001-004C	SWP-D-C	T1: 1
2.0 i.e. (835AI) (86 kW 2.0 Liter)					
09.89 → 07.92	835 A5.000		246-083-001-004C	SWP-D-C	T1: 1
2.0 16V (835ED) (102 kW 2.0 Liter)					
07.94 → 07.99	836 A3.000		246-083-001-004C	SWP-D-C	T1: 1
2.0 i.e. Turbo (835AR) (119 kW 2.0 Liter)					
02.92 → 06.94	835 A8.046		246-083-001-004C	SWP-D-C	T1: 1
2.0 i.e. Turbo Integrale (835AO) (121 kW 2.0 Liter)					
02.92 → 06.94	835 A7.000		246-083-001-004C	SWP-D-C	T1: 1
2.0 HF Integrale (835AP) (124 kW 2.0 Liter)					
02.92 → 06.94	835 A7.046		246-083-001-004C	SWP-D-C	T1: 1
2.0 Turbo (835AQ) (130 kW 2.0 Liter)					
02.92 → 06.94	835 A8.000		246-083-001-004C	SWP-D-C	T1: 1
1.9 TDS (835EE, 835EF) (66 kW 1.9 Liter)					
02.92 → 06.94	160 D1.000 / 835 A4.000 / 835 A4.046		246-083-001-004C	SWP-D-C	T1: 1

DEDRA SW (835)

1.6 (835EB) (66 kW 1.6 Liter)					
10.94 → 07.99	159 B9.000		246-083-001-004C	SWP-D-C	T1: 1



			VDO		
Datum	Motorcode	Fahrgestell Nr.	Artikel Nr.	Artikelbez.	Information

LANCIA

DEDRA SW (835)

1.6 16V (835EI) (76 kW 1.6 Liter)					
01.96 → 07.99	182 A4.000		246-083-001-004C	SWP-D-C	T1: 1
1.8 16V LE (835FG) (83 kW 1.8 Liter)					
03.96 → 07.99	182 A2.000		246-083-001-004C	SWP-D-C	T1: 1
1.8 GT 16V (835EH) (96 kW 1.8 Liter)					
03.96 → 07.99	183 A1.000		246-083-001-004C	SWP-D-C	T1: 1
1.8 i.e. (835FA) (74 kW 1.8 Liter)					
07.94 → 07.99	836 A5.000		246-083-001-004C	SWP-D-C	T1: 1
2.0 16V (835ED) (102 kW 2.0 Liter)					
07.94 → 07.99	836 A3.000		246-083-001-004C	SWP-D-C	T1: 1
2.0 Integrale (835ED) (102 kW 2.0 Liter)					
07.94 → 07.99	836 A3.000		246-083-001-004C	SWP-D-C	T1: 1
1.9 TDS (835EE, 835EF) (66 kW 1.9 Liter)					
07.94 → 07.99	160 D1.000 / 835 A4.000		246-083-001-004C	SWP-D-C	T1: 1

DELTA II (836)

1.4 i.e. (836AF, 836AH) (51 kW 1.4 Liter)					
10.94 → 08.99	160 A1.046 / 836 A4.000		246-083-001-004C	SWP-D-C	T1: 1
1.6 i.e. (836AD) (55 kW 1.6 Liter)					
06.93 → 08.99	835 C1.000		246-083-001-004C	SWP-D-C	T1: 1
1.6 i.e. (836AP) (66 kW 1.6 Liter)					
03.96 → 08.99	182 A6.000		246-083-001-004C	SWP-D-C	T1: 1
1.6 i.e. 16V (836AO) (76 kW 1.6 Liter)					
01.96 → 08.99	182 A4.000		246-083-001-004C	SWP-D-C	T1: 1
1.8 i.e. 16V (836AQ) (83 kW 1.8 Liter)					
03.96 → 08.99	182 A2.000		246-083-001-004C	SWP-D-C	T1: 1
1.8 i.e. 16V GT (836AR) (96 kW 1.8 Liter)					
03.96 → 08.99	183 A1.000		246-083-001-004C	SWP-D-C	T1: 1
1.8 i.e. (836AG, 836AL) (66 kW 1.8 Liter)					
07.94 → 08.99	835 C4.000 / 836 A6.000 / 836 C4.000		246-083-001-004C	SWP-D-C	T1: 1
1.8 i.e. (836AE) (76 kW 1.8 Liter)					
06.93 → 08.99	835 C2.000		246-083-001-004C	SWP-D-C	T1: 1
2.0 16V (836AA, 836CA) (102 kW 2.0 Liter)					
06.93 → 08.99	836 A3.000		246-083-001-004C	SWP-D-C	T1: 1
2.0 16V Turbo (836AB) (137 kW 2.0 Liter)					
06.93 → 08.99	836 A2.000		246-083-001-004C	SWP-D-C	T1: 1
2.0 16V Turbo (836AS) (142 kW 2.0 Liter)					
07.96 → 08.99	175 A4.000		246-083-001-004C	SWP-D-C	T1: 1
1.9 TD (836AM, 836AN) (66 kW 1.9 Liter)					
10.94 → 08.99	160 D1.000 / 835 A4.000		246-083-001-004C	SWP-D-C	T1: 1



			VDO		
Datum	Motorcode	Fahrgestell Nr.	Artikel Nr.	Artikelbez.	Information

LANCIA**LYBRA (839AX)****1.6 16V (839AXA1A) (76 kW | 1.6 Liter)**

07.99 → 182 A4.000 / 182 B6.000 246-083-001-004C SWP-D-C T1: 1

1.8 16V (839AXB1A, 839AXG1A) (96 kW | 1.8 Liter)

07.99 → 839 A4.000 / 839 A7.000 / 839 A9.000 246-083-001-004C SWP-D-C T1: 1

2.0 20V (839AXH1A) (110 kW | 2.0 Liter)

09.00 → 185 A8.000 246-083-001-004C SWP-D-C T1: 1

2.0 20V (839AXC11, 839AXC1A) (113 kW | 2.0 Liter)

07.99 → 09.00 182 B7.000 246-083-001-004C SWP-D-C T1: 1

1.9 JTD (839AXD1A) (77 kW | 1.9 Liter)

07.99 → 09.00 AR 32302 246-083-001-004C SWP-D-C T1: 1

1.9 JTD (839AXI1A) (81 kW | 1.9 Liter)

09.00 → 05.01 AR 37101 246-083-001-004C SWP-D-C T1: 1

1.9 JTD (85 kW | 1.9 Liter)

05.01 → 937 A2.000 246-083-001-004C SWP-D-C T1: 1

2.4 JTD (839AXE1A) (99 kW | 2.4 Liter)

07.99 → 09.00 839 A5.000 / AR 32501 246-083-001-004C SWP-D-C T1: 1

2.4 JTD (839AXL1A) (103 kW | 2.4 Liter)

09.00 → 05.02 839 A6.000 246-083-001-004C SWP-D-C T1: 1

2.4 JTD (110 kW | 2.4 Liter)

05.02 → 841C.000 246-083-001-004C SWP-D-C T1: 1

LYBRA SW (839BX)**1.6 16V (839BXA1A) (76 kW | 1.6 Liter)**

07.99 → 182 A4.000 / 182 B6.000 246-083-001-004C SWP-D-C T1: 1

1.8 16V (839BXB1A, 839BXG1A) (96 kW | 1.8 Liter)

07.99 → 839 A4.000 / 839 A7.000 246-083-001-004C SWP-D-C T1: 1

2.0 20V (839BXH1A) (110 kW | 2.0 Liter)

09.00 → 185 A8.000 246-083-001-004C SWP-D-C T1: 1

2.0 20V (839BXC11, 839BXC1A) (113 kW | 2.0 Liter)

07.99 → 09.00 182 B7.000 246-083-001-004C SWP-D-C T1: 1

1.9 JTD (839BXD1A) (77 kW | 1.9 Liter)

07.99 → 09.00 AR 32302 246-083-001-004C SWP-D-C T1: 1

1.9 JTD (839BXI1A) (81 kW | 1.9 Liter)

09.00 → 05.01 AR 37101 246-083-001-004C SWP-D-C T1: 1

1.9 JTD (85 kW | 1.9 Liter)

05.01 → 937 A2.000 246-083-001-004C SWP-D-C T1: 1

2.4 JTD (839BXE1A) (99 kW | 2.4 Liter)

10.99 → 09.00 839 A5.000 / AR 32501 246-083-001-004C SWP-D-C T1: 1

2.4 JTD (839BXL1A) (103 kW | 2.4 Liter)

09.00 → 839 A6.000 246-083-001-004C SWP-D-C T1: 1

2.4 JTD (110 kW | 2.4 Liter)

05.02 → 841C.000 246-083-001-004C SWP-D-C T1: 1



			VDO		
Datum	Motorcode	Fahrgestell Nr.	Artikel Nr.	Artikelbez.	Information

LANCIA**MUSA****1.4 (57 kW | 1.4 Liter)**09.05 →

			246-083-001-004C	SWP-D-C	T1: 1
--	--	--	------------------	---------	-------

1.4 (70 kW | 1.4 Liter)10.04 →

843 A 1.000			246-083-001-004C	SWP-D-C	T1: 1
-------------	--	--	------------------	---------	-------

1.3 Multijet (51 kW | 1.3 Liter)10.04 →

188 A9.000			246-083-001-004C	SWP-D-C	T1: 1
------------	--	--	------------------	---------	-------

1.9 Multijet (74 kW | 1.9 Liter)10.04 →

188 B2.000			246-083-001-004C	SWP-D-C	T1: 1
------------	--	--	------------------	---------	-------

Y (840A)**1.1 (840AE) (40 kW | 1.1 Liter)**11.95 →

176 B2.000			246-083-001-004C	SWP-D-C	T1: 1
------------	--	--	------------------	---------	-------

1.2 (840AA, 840AF1A) (44 kW | 1.2 Liter)03.96 →

188 A4.000 / 840 A3.000			246-083-001-004C	SWP-D-C	T1: 1
-------------------------	--	--	------------------	---------	-------

1.2 16V (840AG1A) (59 kW | 1.2 Liter)10.00 →

188 A5.000			246-083-001-004C	SWP-D-C	T1: 1
------------	--	--	------------------	---------	-------

1.2 16V (840AD) (63 kW | 1.2 Liter)04.97 →

176 B9.000			246-083-001-004C	SWP-D-C	T1: 1
------------	--	--	------------------	---------	-------

1.4 12V (840AC) (55 kW | 1.4 Liter)03.96 →

840 A4.000			246-083-001-004C	SWP-D-C	T1: 1
------------	--	--	------------------	---------	-------

1.4 12V (840AB) (59 kW | 1.4 Liter)10.96 →

840 A2.000			246-083-001-004C	SWP-D-C	T1: 1
------------	--	--	------------------	---------	-------

YPSILON**1.2 (44 kW | 1.2 Liter)**10.03 →

188 A4.000			246-083-001-004C	SWP-D-C	T1: 1
------------	--	--	------------------	---------	-------

1.2 (59 kW | 1.2 Liter)10.03 →

188 A5.000			246-083-001-004C	SWP-D-C	T1: 1
------------	--	--	------------------	---------	-------

1.4 (70 kW | 1.4 Liter)10.03 →

843 A 1.000			246-083-001-004C	SWP-D-C	T1: 1
-------------	--	--	------------------	---------	-------

1.3 JTD (51 kW | 1.3 Liter)10.03 →

			246-083-001-004C	SWP-D-C	T1: 1
--	--	--	------------------	---------	-------

MAZDA**121 III (JASM, JBSM)****1.25 (55 kW | 1.25 Liter)**03.96 →

DHF / DHG			X10-729-002-004	SWP-M-C	T1: 9
-----------	--	--	-----------------	---------	-------

1.3 (37 kW | 1.3 Liter)03.96 →

			X10-729-002-004	SWP-M-C	T1: 9
--	--	--	-----------------	---------	-------



			VDO		
Datum	Motorcode	Fahrgestell Nr.	Artikel Nr.	Artikelbez.	Information

MAZDA

121 III (JASM, JBSM)

1.3 (44 kW | 1.3 Liter)

03.96 →			X10-729-002-004	SWP-M-C	T1: 9
---------	--	--	-----------------	---------	-------

1.8 D (44 kW | 1.8 Liter)

03.96 →	RTJ / RTK		X10-729-002-004	SWP-M-C	T1: 9
---------	-----------	--	-----------------	---------	-------

MERCEDES-BENZ

A-KLASSE (W168)

A 140 (168.031, 168.131) (60 kW | 1.4 Liter)

07.97 → 08.04	M 166.940		246-075-017-002C	SWP-M-G	T1: 4; T2: C
---------------	-----------	--	------------------	---------	--------------

A-KLASSE (W169)

A 150 (169.031, 169.331) (70 kW | 1.5 Liter)

09.04 →	M 266.920		246-075-017-002C	SWP-M-G	T1: 4; T2: C
---------	-----------	--	------------------	---------	--------------

B-KLASSE (W245)

B 150 (245.231) (70 kW | 1.5 Liter)

03.05 →	M 266.920		246-083-002-022G	SWP-D-C	T1: 3
---------	-----------	--	------------------	---------	-------

B 170 (245.232) (85 kW | 1.7 Liter)

03.05 →	M 266.940		246-083-002-022G	SWP-D-C	T1: 3
---------	-----------	--	------------------	---------	-------

B 200 (245.233) (100 kW | 2.0 Liter)

03.05 →	M 266.960		246-083-002-022G	SWP-D-C	T1: 3
---------	-----------	--	------------------	---------	-------

B 200 TURBO (245.234) (142 kW | 2.0 Liter)

03.05 →	M 266.980		246-083-002-022G	SWP-D-C	T1: 3
---------	-----------	--	------------------	---------	-------

B 180 CDI (245.207) (80 kW | 2.0 Liter)

03.05 →	OM 640.940		246-083-002-022G	SWP-D-C	T1: 3
---------	------------	--	------------------	---------	-------

B 200 CDI (245.208) (103 kW | 2.0 Liter)

03.05 →	OM 640.941		246-083-002-022G	SWP-D-C	T1: 3
---------	------------	--	------------------	---------	-------

190 (W201)

E 1.8 (201.018) (80 kW | 1.8 Liter)

04.90 → 08.93	M 102.910		246-082-005-002C	SWP-M-C	T1: 4
---------------	-----------	--	------------------	---------	-------

04.90 → 08.93	M 102.910		246-082-008-013P	SWP-M-C	T1: 4
---------------	-----------	--	------------------	---------	-------

2.0 (66 kW | 2.0 Liter)

10.82 → 10.84	M 102.921		246-082-005-002C	SWP-M-C	T1: 4
---------------	-----------	--	------------------	---------	-------

12.82 → 10.84	M 102.921		246-082-008-013P	SWP-M-C	T1: 4
---------------	-----------	--	------------------	---------	-------

2.0 (75 kW | 2.0 Liter)

01.86 → 05.90	M 102.924		246-082-005-002C	SWP-M-C	T1: 4
---------------	-----------	--	------------------	---------	-------

07.89 → 05.90	M 102.924		246-082-008-013P	SWP-M-C	T1: 4
---------------	-----------	--	------------------	---------	-------



			VDO		
Datum	Motorcode	Fahrgestell Nr.	Artikel Nr.	Artikelbez.	Information

MERCEDES-BENZ

190 (W201)

2.0 (77 kW 2.0 Liter)					
09.84 → 05.90	M 102.924		246-082-005-002C	SWP-M-C	T1: 4
E 2.0 (83 kW 2.0 Liter)					
02.85 → 12.86	M 102.961 / M 102.962		246-082-005-002C	SWP-M-C	T1: 4
02.85 → 12.86	M 102.961 / M 102.962		246-082-008-013P	SWP-M-C	T1: 4
E 2.0 (85 kW 2.0 Liter)					
02.85 → 12.86	M 102.962		246-082-005-002C	SWP-M-C	T1: 4
02.85 → 12.86	M 102.962		246-082-008-013P	SWP-M-C	T1: 4
E 2.0 (87 kW 2.0 Liter)					
01.85 → 08.93	M 102.962		246-082-005-002C	SWP-M-C	T1: 4
07.89 → 08.93	M 102.962		246-082-008-013P	SWP-M-C	T1: 4
E 2.0 (201.024) (90 kW 2.0 Liter)					
10.82 → 06.93	M 102.961 / M 102.962		246-082-005-002C	SWP-M-C	T1: 4
12.82 → 08.85	M 102.961 / M 102.962		246-082-008-013P	SWP-M-C	T1: 4
E 2.0 (93 kW 2.0 Liter)					
10.82 → 06.93			246-082-005-002C	SWP-M-C	T1: 4
E 2.3 (97 kW 2.3 Liter)					
09.86 → 08.91	M 102.985		246-082-005-002C	SWP-M-C	T1: 4
09.86 → 08.91	M 102.985		246-082-008-013P	SWP-M-C	T1: 4
E 2.3 (201.028) (100 kW 2.3 Liter)					
10.86 → 08.93	M 102.985		246-082-005-002C	SWP-M-C	T1: 4
E 2.3-16 (125 kW 2.3 Liter)					
09.85 → 12.87	M 102.983		246-082-005-002C	SWP-M-C	T1: 4
09.85 → 12.87	M 102.983		246-082-008-013P	SWP-M-C	T1: 4
E 2.3-16 (130 kW 2.3 Liter)					
09.85 → 08.88	M 102.983		246-082-005-002C	SWP-M-C	T1: 4
E 2.3-16 (201.034) (136 kW 2.3 Liter)					
04.84 → 01.87	M 102.983		246-082-005-002C	SWP-M-C	T1: 4
E 2.5-16 (143 kW 2.5 Liter)					
03.89 → 08.93	M 102.991		246-082-005-002C	SWP-M-C	T1: 4
03.89 → 08.93	M 102.991		246-082-008-013P	SWP-M-C	T1: 4
E 2.5-16 (150 kW 2.5 Liter)					
09.88 → 08.93	M 102.990		246-082-005-002C	SWP-M-C	T1: 4
E Evolution II 2.5 (173 kW 2.5 Liter)					
05.90 → 08.93	M 102.992		246-082-005-002C	SWP-M-C	T1: 4
E 2.6 (201.029) (118 kW 2.6 Liter)					
09.86 → 08.93	M 103.942		246-082-005-002C	SWP-M-C	T1: 4
07.89 → 08.93	M 103.942		246-082-008-013P	SWP-M-C	T1: 4
E 2.6 (122 kW 2.6 Liter)					
09.86 → 12.89	M 103.942		246-082-005-002C	SWP-M-C	T1: 4
01.87 → 12.89	M 103.942		246-082-008-013P	SWP-M-C	T1: 4
D 2.0 (201.122) (53 kW 2.0 Liter)					
08.83 → 08.89	OM 601.911		246-082-005-002C	SWP-M-C	T1: 4
12.83 → 08.89	OM 601.911		246-082-008-013P	SWP-M-C	T1: 4



			VDO		
Datum	Motorcode	Fahrgestell Nr.	Artikel Nr.	Artikelbez.	Information

MERCEDES-BENZ**190 (W201)****D 2.0 (201.122) (55 kW | 2.0 Liter)**

08.89 → 08.93 OM 601.911 246-082-005-002C SWP-M-C T1: 4

D 2.5 (201.126) (66 kW | 2.5 Liter)

04.85 → 08.93 OM 602.911 246-082-005-002C SWP-M-C T1: 4

04.85 → 08.93 OM 602.911 246-082-008-013P SWP-M-C T1: 4

D 2.5 (201.126) (69 kW | 2.5 Liter)

08.89 → 08.93 OM 602.911 246-082-005-002C SWP-M-C T1: 4

Turbo-D 2.5 (201.128) (90 kW | 2.5 Liter)

02.88 → 08.93 OM 602.961 246-082-005-002C SWP-M-C T1: 4

02.88 → 08.93 OM 602.961 246-082-008-013P SWP-M-C T1: 4

Turbo-D 2.5 (201.128) (93 kW | 2.5 Liter)

02.88 → 08.93 OM 602.961 246-082-005-002C SWP-M-C T1: 4

C-KLASSE (W202)**C 180 (202.018) (89 kW | 1.8 Liter)**

11.94 → 05.00 M 111.921 → F483847; 246-082-008-013P SWP-M-C T1: 4

→ A436535

11.94 → 05.00 M 111.921 A436536 →; 246-082-008-025G SWP-M-C T1: 3

F483848 →

C 180 (202.018) (90 kW | 1.8 Liter)

03.93 → 05.00 M 111.920 / M 111.921 → A436535; 246-082-008-013P SWP-M-C T1: 4

→ F483847

03.93 → 05.00 M 111.920 / M 111.921 A436536 →; 246-082-008-025G SWP-M-C T1: 3

F483848 →

C 200 (202.020) (100 kW | 2.0 Liter)

01.94 → 05.00 M 111.941 / M 111.945 → A436535; 246-082-008-013P SWP-M-C T1: 4

→ F483847

01.94 → 05.00 M 111.941 / M 111.945 246-082-008-025G SWP-M-C T1: 3

C 200 Kompressor (202.025) (132 kW | 2.0 Liter)

10.95 → 05.00 M 111.944 → A436535; 246-082-008-013P SWP-M-C T1: 4

→ F483847

10.95 → 05.00 M 111.944 F483848 →; 246-082-008-025G SWP-M-C T1: 3

A436536 →

C 200 Kompressor (202.025) (141 kW | 2.0 Liter)

11.96 → 05.00 M 111.944 246-082-008-013P SWP-M-C T1: 4

C 220 (202.022) (110 kW | 2.2 Liter)

03.93 → 05.00 M 111.961 → F483847; 246-082-008-013P SWP-M-C T1: 4

→ A436535





03.93 → 05.00 M 111.961 F483848 →; 246-082-008-025G SWP-M-C T1: 3

A436536 →

C 230 (202.023) (110 kW | 2.3 Liter)

06.96 → 06.97 M 111.974 246-082-008-013P SWP-M-C T1: 4



			VDO		
Datum	Motorcode	Fahrgestell Nr.	Artikel Nr.	Artikelbez.	Information

MERCEDES-BENZ**C-KLASSE (W202)****C 230 Kompressor (202.024) (142 kW | 2.3 Liter)**

10.95 → 05.00	M 111.975	→ F483847; → A436535	246-082-008-013P	SWP-M-C	T1: 4
10.95 → 05.00	M 111.975	F483848 →; A436536 →	246-082-008-025G	SWP-M-C	T1: 3

C 240 (202.026) (125 kW | 2.4 Liter)

06.97 → 05.00	M 112.910		246-082-008-013P	SWP-M-C	T1: 4
06.97 → 05.00	M 112.910		246-082-008-025G	SWP-M-C	T1: 3

C 280 (202.028) (142 kW | 2.8 Liter)

05.93 → 05.00	M 104.941	→ A436535; → F483847	246-082-008-013P	SWP-M-C	T1: 4
05.93 → 05.00	M 104.941	A436536 →; F483848 →	246-082-008-025G	SWP-M-C	T1: 3

C 280 (202.029) (145 kW | 2.8 Liter)

06.97 → 05.00	M 112.920	→ F483847; → A436535	246-082-008-013P	SWP-M-C	T1: 4
06.97 → 05.00	M 112.920	F483848 →; A436536 →	246-082-008-025G	SWP-M-C	T1: 3

C 36 AMG (202.028) (206 kW | 3.6 Liter)

09.94 → 05.00	M 104.941 (AMG 3.6)	→ F483847; → A436535	246-082-008-013P	SWP-M-C	T1: 4
05.94 → 05.00	M 104.941 (AMG 3.6)	F483848 →; A436536 →	246-082-008-025G	SWP-M-C	T1: 3

C 43 AMG (202.033) (225 kW | 4.3 Liter)

10.97 → 05.00	M 113.944		246-082-008-013P	SWP-M-C	T1: 4
10.97 → 05.00	M 113.944		246-082-008-025G	SWP-M-C	T1: 3

C 200 D (202.120) (55 kW | 2.0 Liter)

03.93 → 05.00	OM 601.913		246-082-008-013P	SWP-M-C	T1: 4
---------------	------------	--	------------------	---------	-------

C 200 D (202.122) (65 kW | 2.0 Liter)

10.96 → 05.00	OM 604.915		246-082-008-013P	SWP-M-C	T1: 4
10.96 → 05.00	OM 604.915		246-082-008-025G	SWP-M-C	T1: 3

C 200 CDI (202.134) (75 kW | 2.2 Liter)

07.98 → 05.00	OM 611.960		246-082-008-013P	SWP-M-C	T1: 4
07.98 → 05.00	OM 611.960		246-082-008-025G	SWP-M-C	T1: 3

C 220 CDI (202.133) (92 kW | 2.2 Liter)

03.98 → 05.00	OM 611.960		246-082-008-013P	SWP-M-C	T1: 4
03.98 → 05.00	OM 611.960		246-082-008-025G	SWP-M-C	T1: 3

C 220 D (55 kW | 2.2 Liter)

07.96 → 05.00	OM 604.910	→ F483847; → A436535	246-082-008-013P	SWP-M-C	T1: 4
07.96 → 05.00	OM 604.910	F483848 →; A436536 →	246-082-008-025G	SWP-M-C	T1: 3

C 220 D (202.121) (70 kW | 2.2 Liter)

08.93 → 05.00	OM 604.910		246-082-008-013P	SWP-M-C	T1: 4
---------------	------------	--	------------------	---------	-------



			VDO		
Datum	Motorcode	Fahrgestell Nr.	Artikel Nr.	Artikelbez.	Information

MERCEDES-BENZ**C-KLASSE (W202)****C 250 D (202.125) (83 kW | 2.5 Liter)**

05.93 → 05.00	OM 605.910		246-082-008-013P	SWP-M-C	T1: 4
---------------	------------	--	------------------	---------	-------

C 250 Turbo-D (202.128) (110 kW | 2.5 Liter)

10.95 → 05.00	OM 605.960	→ F483847; → A436535	246-082-008-013P	SWP-M-C	T1: 4
---------------	------------	-------------------------	------------------	---------	-------

10.95 → 05.00	OM 605.960	F483848 →; A436536 →	246-082-008-025G	SWP-M-C	T1: 3
---------------	------------	-------------------------	------------------	---------	-------

C-KLASSE Kombi (S202)**C 180 T (202.078) (90 kW | 1.8 Liter)**

06.96 → 09.00	M 111.920 / M 111.921		246-082-008-013P	SWP-M-C	T1: 4
---------------	-----------------------	--	------------------	---------	-------

06.96 → 09.00	M 111.920 / M 111.921		246-082-008-025G	SWP-M-C	T1: 3
---------------	-----------------------	--	------------------	---------	-------

C 180 T (202.081) (95 kW | 2.0 Liter)

09.00 → 03.01	M 111.952		246-082-008-013P	SWP-M-C	T1: 4
---------------	-----------	--	------------------	---------	-------

09.00 → 03.01	M 111.952		246-082-008-025G	SWP-M-C	T1: 3; T13: A210 869 08 021
---------------	-----------	--	------------------	---------	--------------------------------

C 200 T (202.080) (100 kW | 2.0 Liter)

06.96 → 03.01	M 111.941 / M 111.945		246-082-008-013P	SWP-M-C	T1: 4
---------------	-----------------------	--	------------------	---------	-------

06.96 → 03.01	M 111.941 / M 111.945		246-082-008-025G	SWP-M-C	T1: 3
---------------	-----------------------	--	------------------	---------	-------

C 200 T Kompressor (202.082) (141 kW | 2.0 Liter)

11.96 → 03.01	M 111.944		246-082-008-013P	SWP-M-C	T1: 4
---------------	-----------	--	------------------	---------	-------

11.96 → 03.01	M 111.944		246-082-008-025G	SWP-M-C	T1: 3; T13: A210 869 08 21
---------------	-----------	--	------------------	---------	-------------------------------

C 200 T Kompressor (202.087) (120 kW | 2.0 Liter)

09.00 → 03.01	M 111.956		246-082-008-013P	SWP-M-C	T1: 4
---------------	-----------	--	------------------	---------	-------

09.00 → 03.01	M 111.956		246-082-008-025G	SWP-M-C	T1: 3; T13: A210 869 08 021
---------------	-----------	--	------------------	---------	--------------------------------

C 230 T (202.083) (110 kW | 2.3 Liter)

06.96 → 06.98	M 111.974		246-082-008-013P	SWP-M-C	T1: 4
---------------	-----------	--	------------------	---------	-------

06.96 → 06.98	M 111.974		246-082-008-025G	SWP-M-C	T1: 3
---------------	-----------	--	------------------	---------	-------

C 230 T Kompressor (202.085) (142 kW | 2.3 Liter)

06.97 → 09.00	M 111.975		246-082-008-013P	SWP-M-C	T1: 4
---------------	-----------	--	------------------	---------	-------

06.97 → 09.00	M 111.975		246-082-008-025G	SWP-M-C	T1: 3; T13: A210 869 08 21
---------------	-----------	--	------------------	---------	-------------------------------

C 240 T (202.086) (125 kW | 2.4 Liter)

06.97 → 09.00	M 112.910		246-082-008-013P	SWP-M-C	T1: 4
---------------	-----------	--	------------------	---------	-------

06.97 → 09.00	M 112.910		246-082-008-025G	SWP-M-C	T1: 3; T13: A210 869 08 21
---------------	-----------	--	------------------	---------	-------------------------------

C 240 T (202.088) (125 kW | 2.6 Liter)

09.00 → 03.01	M 112.915		246-082-008-013P	SWP-M-C	T1: 4
---------------	-----------	--	------------------	---------	-------

09.00 → 03.01	M 112.915		246-082-008-025G	SWP-M-C	T1: 3; T13: A210 869 08 021
---------------	-----------	--	------------------	---------	--------------------------------



			VDO		
Datum	Motorcode	Fahrgestell Nr.	Artikel Nr.	Artikelbez.	Information

MERCEDES-BENZ





C-KLASSE Kombi (S202)

C 280 T (202.089) (145 kW 2.8 Liter)					
06.97 → 03.01	M 112.920		246-082-008-013P	SWP-M-C	T1: 4
06.97 → 03.01	M 112.920		246-082-008-025G	SWP-M-C	T1: 3; T13: A210 869 08 21
C 43 AMG (202.093) (225 kW 4.3 Liter)					
08.97 → 03.01	M 113.944		246-082-008-013P	SWP-M-C	T1: 4
08.97 → 03.01	M 113.944		246-082-008-025G	SWP-M-C	T1: 3; T13: A210 869 08 021
C 200 T D (202.180) (65 kW 2.0 Liter)					
10.96 → 03.01	OM 604.915		246-082-008-013P	SWP-M-C	T1: 4
10.96 → 03.01	OM 604.915		246-082-008-025G	SWP-M-C	T1: 3
C 200 T CDI (202.194) (75 kW 2.2 Liter)					
03.98 → 03.01	OM 611.960		246-082-008-013P	SWP-M-C	T1: 4
03.98 → 03.01	OM 611.960		246-082-008-025G	SWP-M-C	T1: 3; T13: A210 869 08 21
C 220 T CDI (202.193) (92 kW 2.2 Liter)					
09.97 → 03.01	OM 611.960		246-082-008-013P	SWP-M-C	T1: 4
09.97 → 03.01	OM 611.960		246-082-008-025G	SWP-M-C	T1: 3; T13: A210 869 08 21
C 220 T D (55 kW 2.2 Liter)					
06.96 → 03.01	OM 604.910		246-082-008-013P	SWP-M-C	T1: 4
06.96 → 03.01	OM 604.910		246-082-008-025G	SWP-M-C	T1: 3
C 220 T D (202.182) (70 kW 2.2 Liter)					
06.96 → 09.98	OM 604.910		246-082-008-013P	SWP-M-C	T1: 4
06.96 → 09.98	OM 604.910		246-082-008-025G	SWP-M-C	T1: 3; T13: A210 869 08 21
C 250 T Turbo-D (202.188) (110 kW 2.5 Liter)					
06.96 → 03.01	OM 605.960		246-082-008-013P	SWP-M-C	T1: 4
06.96 → 03.01	OM 605.960		246-082-008-025G	SWP-M-C	T1: 3

C-KLASSE (W203)

C 180 Kompressor (203.046) (105 kW 1.8 Liter)					
05.02 →	M 271.946		246-082-008-025G	SWP-M-C	T1: 3
C 180 (203.035) (95 kW 2.0 Liter)					
10.00 → 05.02	M 111.951		246-082-008-025G	SWP-M-C	T1: 3
C 200 Kompressor (203.042) (120 kW 1.8 Liter)					
05.02 →	M 271.940		246-082-008-025G	SWP-M-C	T1: 3
C 200 Kompressor (203.045) (120 kW 2.0 Liter)					
05.00 → 05.02	M 111.955		246-082-008-025G	SWP-M-C	T1: 3
C 200 CGI Kompressor (203.043) (125 kW 1.8 Liter)					
07.03 →	M 271.942		246-082-008-025G	SWP-M-C	T1: 3
C 230 Kompressor (203.040) (141 kW 1.8 Liter)					
02.04 →	M 271.948		246-082-008-025G	SWP-M-C	T1: 3



			VDO		
Datum	Motorcode	Fahrgestell Nr.	Artikel Nr.	Artikelbez.	Information

MERCEDES-BENZ

C-KLASSE (W203)

C 230 (203.052) (150 kW 2.5 Liter)					
01.05 →	M 272.920		246-082-008-025G	SWP-M-C	T1: 3
C 240 (203.061) (125 kW 2.6 Liter)					
05.00 →	M 112.912		246-082-008-025G	SWP-M-C	T1: 3
C 240 4-matic (203.081) (125 kW 2.6 Liter)					
07.02 →	M 112.916		246-082-008-025G	SWP-M-C	T1: 3
C 280 (203.054) (170 kW 3.0 Liter)					
01.05 →	M 272.940		246-082-008-025G	SWP-M-C	T1: 3
C 280 4-matic (203.092) (170 kW 3.0 Liter)					
01.05 →	M 272.941		246-082-008-025G	SWP-M-C	T1: 3
C 320 (203.064) (160 kW 3.2 Liter)					
05.00 →	M 112.946		246-082-008-025G	SWP-M-C	T1: 3
C 320 4-matic (203.084) (160 kW 3.2 Liter)					
07.02 →	M 112.953		246-082-008-025G	SWP-M-C	T1: 3
C 350 (203.056) (200 kW 3.5 Liter)					
01.05 →	M 272.960		246-082-008-025G	SWP-M-C	T1: 3
C 350 4-matic (203.087) (200 kW 3.5 Liter)					
01.05 →	M 272.970		246-082-008-025G	SWP-M-C	T1: 3
C 32 AMG Kompressor (203.065) (260 kW 3.2 Liter)					
02.01 →	M 112.961		246-082-008-025G	SWP-M-C	T1: 3
C 55 AMG (203.076) (270 kW 5.4 Liter)					
02.04 →	M 113.988		246-082-008-025G	SWP-M-C	T1: 3
C 200 CDI (75 kW 2.2 Liter)					
02.01 →	OM 646.962		246-082-008-025G	SWP-M-C	T1: 3
C 200 CDI (203.004) (85 kW 2.2 Liter)					
09.00 →	OM 611.962		246-082-008-025G	SWP-M-C	T1: 3
C 200 CDI (203.007) (90 kW 2.2 Liter)					
04.03 →	OM 646.962		246-082-008-025G	SWP-M-C	T1: 3
C 220 CDI (203.006) (105 kW 2.2 Liter)					
05.00 →	OM 611.962		246-082-008-025G	SWP-M-C	T1: 3
C 220 CDI (203.008) (110 kW 2.2 Liter)					
02.04 →	OM 646.963		246-082-008-025G	SWP-M-C	T1: 3
C 270 CDI (203.016) (125 kW 2.7 Liter)					
12.00 →	OM 612.962		246-082-008-025G	SWP-M-C	T1: 3
C 30 CDI AMG (203.018) (170 kW 3.0 Liter)					
01.03 →	OM 612.990		246-082-008-025G	SWP-M-C	T1: 3
C 320 CDI (203.020) (165 kW 3.0 Liter)					
01.05 →	OM 642.910		246-082-008-025G	SWP-M-C	T1: 3

C-KLASSE Kombi (S203)

C 180 Kompressor (203.246) (105 kW 1.8 Liter)					
05.02 →	M 271.946		246-082-008-025G	SWP-M-C	T1: 3
C 180 (203.235) (95 kW 2.0 Liter)					
03.01 → 05.02	M 111.951		246-082-008-025G	SWP-M-C	T1: 3



			VDO		
Datum	Motorcode	Fahrgestell Nr.	Artikel Nr.	Artikelbez.	Information

MERCEDES-BENZ

C-KLASSE Kombi (S203)

C 200 Kompressor (203.242) (120 kW 1.8 Liter)					
05.02 →	M 271.940		246-082-008-025G	SWP-M-C	T1: 3
C 200 Kompressor (203.245) (120 kW 2.0 Liter)					
03.01 → 05.02	M 111.955		246-082-008-025G	SWP-M-C	T1: 3
C 200 CGI Kompressor (203.243) (125 kW 1.8 Liter)					
07.03 →	M 271.942		246-082-008-025G	SWP-M-C	T1: 3
C 230 Kompressor (203.240) (141 kW 1.8 Liter)					
02.04 →	M 271.948		246-082-008-025G	SWP-M-C	T1: 3
C 230 (203.252) (150 kW 2.5 Liter)					
01.05 →	M 272.920		246-082-008-025G	SWP-M-C	T1: 3
C 240 (203.261) (125 kW 2.6 Liter)					
03.01 →	M 112.912		246-082-008-025G	SWP-M-C	T1: 3
C 240 4-matic (203.281) (125 kW 2.6 Liter)					
07.02 →	M 112.916		246-082-008-025G	SWP-M-C	T1: 3
C 280 (203.254) (170 kW 3.0 Liter)					
01.05 →	M 272.940		246-082-008-025G	SWP-M-C	T1: 3
C 280 4-matic (203.292) (170 kW 3.0 Liter)					
01.05 →	M 272.941		246-082-008-025G	SWP-M-C	T1: 3
C 320 (203.264) (160 kW 3.2 Liter)					
03.01 →	M 112.946		246-082-008-025G	SWP-M-C	T1: 3
C 320 4-matic (203.284) (160 kW 3.2 Liter)					
07.02 →	M 112.953		246-082-008-025G	SWP-M-C	T1: 3
C 350 (203.256) (200 kW 3.5 Liter)					
01.05 →	M 272.960		246-082-008-025G	SWP-M-C	T1: 3
C 350 4-matic (203.287) (200 kW 3.5 Liter)					
01.05 →	M 272.970		246-082-008-025G	SWP-M-C	T1: 3
C 32 AMG Kompressor (203.265) (260 kW 3.2 Liter)					
03.01 →	M 112.961		246-082-008-025G	SWP-M-C	T1: 3
C 200 CDI (75 kW 2.2 Liter)					
03.01 →	OM 646.962		246-082-008-025G	SWP-M-C	T1: 3
C 200 CDI (203.204) (85 kW 2.2 Liter)					
03.01 →	OM 611.962		246-082-008-025G	SWP-M-C	T1: 3
C 200 CDI (203.207) (90 kW 2.2 Liter)					
04.03 →	OM 646.962		246-082-008-025G	SWP-M-C	T1: 3
C 220 CDI (203.206) (105 kW 2.2 Liter)					
03.01 →	OM 611.962		246-082-008-025G	SWP-M-C	T1: 3
C 220 CDI (203.208) (110 kW 2.2 Liter)					
02.04 →	OM 646.963		246-082-008-025G	SWP-M-C	T1: 3
C 270 CDI (203.216) (125 kW 2.7 Liter)					
03.01 →	OM 612.962		246-082-008-025G	SWP-M-C	T1: 3
C 30 CDI AMG (203.218) (170 kW 3.0 Liter)					
01.03 →	OM 612.990		246-082-008-025G	SWP-M-C	T1: 3



			VDO		
Datum	Motorcode	Fahrgestell Nr.	Artikel Nr.	Artikelbez.	Information

MERCEDES-BENZ

CLK (C208)

200 (208.335) (100 kW 2.0 Liter)					
06.97 → 06.02	M 111.941 / M 111.945		246-082-008-025G	SWP-M-C	T1: 3
200 Kompressor (208.344) (120 kW 2.0 Liter)					
06.00 → 06.02	M 111.956		246-082-008-025G	SWP-M-C	T1: 3
200 Kompressor (208.345) (141 kW 2.0 Liter)					
06.97 → 06.00	M 111.944		246-082-008-025G	SWP-M-C	T1: 3
230 Kompressor (208.347) (142 kW 2.3 Liter)					
06.97 → 06.00	M 111.973 / M 111.975		246-082-008-025G	SWP-M-C	T1: 3
230 Kompressor (208.348) (145 kW 2.3 Liter)					
06.00 → 06.02	M 111.982		246-082-008-025G	SWP-M-C	T1: 3
320 (208.365) (160 kW 3.2 Liter)					
06.97 → 06.02	M 112.940		246-082-008-025G	SWP-M-C	T1: 3
430 (208.370) (205 kW 4.3 Liter)					
07.98 → 06.02	M 113.943		246-082-008-025G	SWP-M-C	T1: 3
55 AMG (208.374) (255 kW 5.4 Liter)					
08.99 → 06.02	M 113.981 / M 113.984		246-082-008-025G	SWP-M-C	T1: 3





CLK Cabriolet (A208)

200 Kompressor (208.444) (120 kW 2.0 Liter)					
06.00 → 03.02	M 111.956		246-082-008-025G	SWP-M-C	T1: 3
230 Kompressor (208.448) (145 kW 2.3 Liter)					
06.00 → 03.02	M 111.982		246-082-008-025G	SWP-M-C	T1: 3
320 (208.465) (160 kW 3.2 Liter)					
06.98 → 03.02	M 112.940		246-082-008-025G	SWP-M-C	T1: 3

CLK (C209)

200 Kompressor (209.342) (120 kW 1.8 Liter)					
09.02 →	M 271.940		246-082-008-025G	SWP-M-C	T1: 3
200 CGI (209.343) (125 kW 1.8 Liter)					
07.03 →	M 271.942		246-082-008-025G	SWP-M-C	T1: 3
240 (209.361) (125 kW 2.6 Liter)					
06.02 →	M 112.912		246-082-008-025G	SWP-M-C	T1: 3
280 (209.354) (170 kW 3.0 Liter)					
01.05 →	M 272.940		246-082-008-025G	SWP-M-C	T1: 3
320 (209.365) (160 kW 3.2 Liter)					
06.02 →	M 112.955		246-082-008-025G	SWP-M-C	T1: 3
350 (209.356) (200 kW 3.5 Liter)					
01.05 →	M 272.960		246-082-008-025G	SWP-M-C	T1: 3
500 (209.375) (225 kW 5.0 Liter)					
06.02 →	M 113.968		246-082-008-025G	SWP-M-C	T1: 3
55 AMG (209.376) (270 kW 5.4 Liter)					
09.02 →	M 113.987		246-082-008-025G	SWP-M-C	T1: 3



			VDO		
Datum	Motorcode	Fahrgestell Nr.	Artikel Nr.	Artikelbez.	Information

MERCEDES-BENZ

CLK (C209)

CLK DTM AMG (428 kW 5.4 Liter)					
06.04 →	M 113.994		246-082-008-025G	SWP-M-C	T1: 3
220 CDI (209.308) (110 kW 2.2 Liter)					
01.05 →	OM 646.963		246-082-008-025G	SWP-M-C	T1: 3
270 CDI (209.316) (125 kW 2.7 Liter)					
10.02 →	OM 612.962 / OM 612.967		246-082-008-025G	SWP-M-C	T1: 3
320 CDI (209.320) (165 kW 3.0 Liter)					
01.05 →	OM 642.910		246-082-008-025G	SWP-M-C	T1: 3

Stufenheck (W123)

200 (62 kW 2.0 Liter)					
02.76 → 08.80	M 115.938 / M 115.939		246-082-005-002C	SWP-M-C	T1: 4
200 (123.020) (69 kW 2.0 Liter)					
02.76 → 08.80	M 115.938 / M 115.939		246-069-026-001G	N	
02.76 → 08.80	M 115.938 / M 115.939		246-082-005-002C	SWP-M-C	T1: 4
200 (74 kW 2.0 Liter)					
06.80 → 11.85	M 102.939		246-082-005-002C	SWP-M-C	T1: 4
06.80 → 11.85	M 102.939		246-082-008-013P	SWP-M-C	T1: 4
200 (123.220) (80 kW 2.0 Liter)					
06.80 → 11.85	M 102.920		246-069-026-001G	N	
06.80 → 11.85	M 102.920		246-082-005-002C	SWP-M-C	T1: 4
230 (123.023) (80 kW 2.3 Liter)					
02.76 → 03.81	M 115.954		246-069-026-001G	N	
02.76 → 03.81	M 115.954		246-082-005-002C	SWP-M-C	T1: 4
02.76 → 02.81	M 115.954		246-082-008-013P	SWP-M-C	T1: 4
230 E (123.223) (100 kW 2.3 Liter)					
04.80 → 12.85	M 102.980		246-069-026-001G	N	
04.80 → 12.85	M 102.980		246-082-005-002C	SWP-M-C	T1: 4
04.80 → 12.85	M 102.980		246-082-008-013P	SWP-M-C	T1: 4
250 (123.026) (95 kW 2.5 Liter)					
02.76 → 10.79	M 123.921		246-069-026-001G	N	
02.76 → 10.79	M 123.921		246-082-005-002C	SWP-M-C	T1: 4
02.76 → 09.79	M 123.921		246-082-008-013P	SWP-M-C	T1: 4
250 (123.026) (103 kW 2.5 Liter)					
10.79 → 07.85	M 123.921		246-069-026-001G	N	
10.79 → 07.85	M 123.921		246-082-005-002C	SWP-M-C	T1: 4
10.79 → 07.85	M 123.921		246-082-008-013P	SWP-M-C	T1: 4
280 (123.030) (115 kW 2.7 Liter)					
02.76 → 08.81	M 110.923		246-069-026-001G	N	
02.76 → 08.81	M 110.923		246-082-005-002C	SWP-M-C	T1: 4
02.76 → 07.81	M 110.923		246-082-008-013P	SWP-M-C	T1: 4
280 E (130 kW 2.7 Liter)					
08.76 → 08.81	M 110.988		246-082-005-002C	SWP-M-C	T1: 4
08.76 → 08.81	M 110.988		246-082-008-013P	SWP-M-C	T1: 4



			VDO		
Datum	Motorcode	Fahrgestell Nr.	Artikel Nr.	Artikelbez.	Information

MERCEDES-BENZ**Stufenheck (W123)**

280 E (123.033) (136 kW 2.7 Liter)					
02.76 → 11.85	M 110.984 / M 110.988		246-069-026-001G	N	
02.76 → 11.85	M 110.984 / M 110.988		246-082-005-002C	SWP-M-C	T1: 4
200 D (123.120) (40 kW 2.0 Liter)					
07.76 → 02.79	OM 615.940		246-069-026-001G	N	
07.76 → 02.79	OM 615.940		246-082-005-002C	SWP-M-C	T1: 4
200 D (44 kW 2.0 Liter)					
03.79 → 11.85	OM 615.940		246-082-005-002C	SWP-M-C	T1: 4
220 D (123.126) (44 kW 2.2 Liter)					
01.76 → 02.79	OM 615.941		246-069-026-001G	N	
01.76 → 02.79	OM 615.941		246-082-005-002C	SWP-M-C	T1: 4
220 D (49 kW 2.2 Liter)					
01.77 → 03.79	OM 615.941		246-082-005-002C	SWP-M-C	T1: 4
240 D (123.123) (48 kW 2.4 Liter)					
02.76 → 02.79	OM 616.912		246-069-026-001G	N	
02.76 → 02.79	OM 616.912		246-082-005-002C	SWP-M-C	T1: 4
240 D (123.123) (53 kW 2.4 Liter)					
03.79 → 11.85	OM 616.912		246-069-026-001G	N	
03.79 → 11.85	OM 616.912		246-082-005-002C	SWP-M-C	T1: 4
300 D (123.130) (59 kW 2.9 Liter)					
02.76 → 07.80	OM 617.912		246-069-026-001G	N	
02.76 → 07.80	OM 617.912		246-082-005-002C	SWP-M-C	T1: 4
02.76 → 07.80	OM 617.912		246-082-008-013P	SWP-M-C	T1: 4
300 D (123.130) (65 kW 2.9 Liter)					
03.79 → 11.85	OM 617.912		246-069-026-001G	N	
03.79 → 11.85	OM 617.912		246-082-005-002C	SWP-M-C	T1: 4
300 Turbo-D (123.133) (92 kW 2.9 Liter)					
08.81 → 07.85	OM 617.952		246-082-005-002C	SWP-M-C	T1: 4

KOMBI Kombi (S123)

200 T (123.280) (74 kW 2.0 Liter)					
11.80 → 11.85	M 102.939		246-069-026-001G	N	
11.80 → 11.85	M 102.939		246-082-005-002C	SWP-M-C	T1: 4
11.80 → 11.85	M 102.939		246-082-008-013P	SWP-M-C	T1: 4
200 T (80 kW 2.0 Liter)					
11.80 → 11.85	M 102.920		246-082-005-002C	SWP-M-C	T1: 4
230 T (123.083) (80 kW 2.3 Liter)					
09.77 → 03.80	M 115.954		246-069-026-001G	N	
09.77 → 03.80	M 115.954		246-082-005-002C	SWP-M-C	T1: 4
04.78 → 03.80	M 115.954		246-082-008-013P	SWP-M-C	T1: 4
230 TE (123.283) (100 kW 2.3 Liter)					
04.80 → 11.85	M 102.980		246-069-026-001G	N	
04.80 → 11.85	M 102.980		246-082-005-002C	SWP-M-C	T1: 4
06.80 → 11.85	M 102.980		246-082-008-013P	SWP-M-C	T1: 4



			VDO		
Datum	Motorcode	Fahrgestell Nr.	Artikel Nr.	Artikelbez.	Information

MERCEDES-BENZ**KOMBI Kombi (S123)**

250 T (123.086) (95 kW 2.5 Liter)					
05.78 → 10.79	M 123.921		246-069-026-001G	N	
05.78 → 10.79	M 123.921		246-082-005-002C	SWP-M-C	T1: 4
250 T (123.086) (103 kW 2.5 Liter)					
05.78 → 08.82	M 123.921		246-069-026-001G	N	
05.78 → 08.82	M 123.921		246-082-005-002C	SWP-M-C	T1: 4
280 TE (123.093) (136 kW 2.7 Liter)					
09.77 → 11.85	M 110.988		246-069-026-001G	N	
09.77 → 11.85	M 110.988		246-082-005-002C	SWP-M-C	T1: 4
04.78 → 11.85	M 110.988		246-082-008-013P	SWP-M-C	T1: 4
240 T D (48 kW 2.4 Liter)					
09.77 → 02.79	OM 616.912		246-082-005-002C	SWP-M-C	T1: 4
240 T D (123.183) (53 kW 2.4 Liter)					
03.79 → 12.85	OM 616.912		246-069-026-001G	N	
03.79 → 12.85	OM 616.912		246-082-005-002C	SWP-M-C	T1: 4
03.79 → 12.85	OM 616.912		246-082-008-013P	SWP-M-C	T1: 4
300 T D (123.190) (59 kW 2.9 Liter)					
09.77 → 10.85	OM 617.912		246-069-026-001G	N	
09.77 → 10.85	OM 617.912		246-082-005-002C	SWP-M-C	T1: 4
04.78 → 10.85	OM 617.912		246-082-008-013P	SWP-M-C	T1: 4
300 T D (123.190) (65 kW 2.9 Liter)					
03.79 → 11.85	OM 617.912		246-069-026-001G	N	
03.79 → 11.85	OM 617.912		246-082-005-002C	SWP-M-C	T1: 4
300 T Turbo-D (123.193) (92 kW 2.9 Liter)					
10.80 → 11.85	OM 617.952		246-069-026-001G	N	
10.80 → 11.85	OM 617.952		246-082-005-002C	SWP-M-C	T1: 4
10.80 → 11.85	OM 617.952		246-082-008-013P	SWP-M-C	T1: 4

COUPE (C123)

230 C (123.043) (80 kW 2.3 Liter)					
05.77 → 04.80	M 115.954		246-069-026-001G	N	
05.77 → 04.80	M 115.954		246-082-008-013P	SWP-M-C	T1: 4
230 CE (123.243) (100 kW 2.3 Liter)					
04.80 → 12.85	M 102.980		246-069-026-001G	N	
06.80 → 07.85	M 102.980		246-082-008-013P	SWP-M-C	T1: 4
280 C (123.050) (115 kW 2.7 Liter)					
03.77 → 03.80	M 110.923		246-069-026-001G	N	
03.77 → 03.80	M 110.923		246-082-008-013P	SWP-M-C	T1: 4
280 CE (130 kW 2.7 Liter)					
09.77 → 08.79	M 110.988		246-082-008-013P	SWP-M-C	T1: 4
280 CE (136 kW 2.7 Liter)					
03.77 → 07.85	M 110.988		246-082-008-013P	SWP-M-C	T1: 4
300 C Turbo-D (123.153) (92 kW 2.9 Liter)					
09.81 → 07.85	OM 617.952		246-069-026-001G	N	



			VDO		
Datum	Motorcode	Fahrgestell Nr.	Artikel Nr.	Artikelbez.	Information

MERCEDES-BENZ**Stufenheck (W124)**

200 (124.020) (75 kW 2.0 Liter)					
01.86 → 05.90	M 102.922		246-082-005-002C	SWP-M-C	T1: 4
01.86 → 02.90	M 102.922		246-082-008-013P	SWP-M-C	T1: 4
200 (77 kW 2.0 Liter)					
01.86 → 05.90	M 102.922		246-082-005-002C	SWP-M-C	T1: 4
200 (124.020) (80 kW 2.0 Liter)					
12.85 → 05.90	M 102.922		246-082-005-002C	SWP-M-C	T1: 4
200 E (124.021) (87 kW 2.0 Liter)					
09.88 → 08.92	M 102.963		246-082-005-002C	SWP-M-C	T1: 4
09.88 → 08.92	M 102.963		246-082-008-013P	SWP-M-C	T1: 4
200 E (124.021) (90 kW 2.0 Liter)					
09.88 → 12.89	M 102.963		246-082-005-002C	SWP-M-C	T1: 4
200 E (124.019) (100 kW 2.0 Liter)					
10.92 → 06.93	M 111.940		246-082-005-002C	SWP-M-C	T1: 4
10.92 → 06.93	M 111.940		246-082-008-013P	SWP-M-C	T1: 4
220 E (124.022) (110 kW 2.2 Liter)					
10.92 → 06.93	M 111.960		246-082-005-002C	SWP-M-C	T1: 4
10.92 → 06.93	M 111.960		246-082-008-013P	SWP-M-C	T1: 4
230 E (124.023) (97 kW 2.3 Liter)					
12.84 → 03.92	M 102.982		246-082-005-002C	SWP-M-C	T1: 4
230 E (124.023) KAT (97 kW 2.3 Liter)					
06.89 → 06.93	M 102.982		246-082-005-002C	SWP-M-C	T1: 4
06.89 → 09.92	M 102.982		246-082-008-013P	SWP-M-C	T1: 4
230 E (124.023) (100 kW 2.3 Liter)					
01.85 → 06.93	M 102.982		246-082-005-002C	SWP-M-C	T1: 4
260 E (124.026) (118 kW 2.6 Liter)					
09.85 → 08.92	M 103.940		246-082-005-002C	SWP-M-C	T1: 4
09.85 → 08.92	M 103.940		246-082-008-013P	SWP-M-C	T1: 4
260 E 4-matic (124.226) (118 kW 2.6 Liter)					
09.86 → 08.92	M 103.943		246-082-005-002C	SWP-M-C	T1: 4
09.86 → 08.92	M 103.943		246-082-008-013P	SWP-M-C	T1: 4
260 E (124.026) (122 kW 2.6 Liter)					
09.85 → 12.89	M 103.940		246-082-005-002C	SWP-M-C	T1: 4
260 E 4-matic (124.226) (122 kW 2.6 Liter)					
12.86 → 12.89	M 103.940		246-082-005-002C	SWP-M-C	T1: 4
12.86 → 12.89	M 103.940		246-082-008-013P	SWP-M-C	T1: 4
280 E (124.028) (145 kW 2.8 Liter)					
10.92 → 06.93	M 104.942		246-082-005-002C	SWP-M-C	T1: 4
10.92 → 06.93	M 104.942		246-082-008-013P	SWP-M-C	T1: 4
300 E (124.030) (132 kW 3.0 Liter)					
08.85 → 08.92	M 103.983		246-082-005-002C	SWP-M-C	T1: 4
08.85 → 08.92	M 103.983		246-082-008-013P	SWP-M-C	T1: 4
300 E 4-matic (124.230) (132 kW 3.0 Liter)					
09.86 → 06.93	M 103.985		246-082-005-002C	SWP-M-C	T1: 4
11.86 → 09.92	M 103.985		246-082-008-013P	SWP-M-C	T1: 4







			VDO		
Datum	Motorcode	Fahrgestell Nr.	Artikel Nr.	Artikelbez.	Information

MERCEDES-BENZ

Stufenheck (W124)

300 E (138 kW 2.9 Liter)					
01.85 → 12.85	M 103.980		246-082-005-002C	SWP-M-C	T1: 4
03.85 → 08.85	M 103.980		246-082-008-013P	SWP-M-C	T1: 4
300 E (138 kW 3.0 Liter)					
06.85 → 08.92	M 103.983		246-082-005-002C	SWP-M-C	T1: 4
300 E 4-matic (138 kW 3.0 Liter)					
09.86 → 02.92	M 103.983		246-082-005-002C	SWP-M-C	T1: 4
300 E-24 (124.031) (162 kW 3.0 Liter)					
09.88 → 08.92	M 104.980		246-082-005-002C	SWP-M-C	T1: 4
07.89 → 08.92	M 104.980		246-082-008-013P	SWP-M-C	T1: 4
320 E (124.032) (162 kW 3.2 Liter)					
10.92 → 06.93	M 104.992		246-082-005-002C	SWP-M-C	T1: 4
10.92 → 06.93	M 104.992		246-082-008-013P	SWP-M-C	T1: 4
400 E 4.2 (124.034) (205 kW 4.2 Liter)					
10.92 → 06.93	M 119.975		246-082-005-002C	SWP-M-C	T1: 4
10.92 → 06.93	M 119.975		246-082-008-013P	SWP-M-C	T1: 4
500 E (124.036) (240 kW 5.0 Liter)					
01.91 → 06.93	M 119.974		246-082-005-002C	SWP-M-C	T1: 4
01.91 → 06.93	M 119.974		246-082-008-013P	SWP-M-C	T1: 4
200 D (124.120) (53 kW 2.0 Liter)					
12.84 → 08.89	OM 601.912		246-082-005-002C	SWP-M-C	T1: 4
12.84 → 08.89	OM 601.912		246-082-008-013P	SWP-M-C	T1: 4
200 D (124.120) (55 kW 2.0 Liter)					
08.89 → 06.93	OM 601.912		246-082-005-002C	SWP-M-C	T1: 4
250 D (124.125) (66 kW 2.5 Liter)					
04.85 → 06.93	OM 602.912		246-082-005-002C	SWP-M-C	T1: 4
04.85 → 06.93	OM 602.912		246-082-008-013P	SWP-M-C	T1: 4
250 D (124.125) (69 kW 2.5 Liter)					
01.89 → 06.93	OM 602.912		246-082-005-002C	SWP-M-C	T1: 4
250 Turbo-D (124.128) (93 kW 2.5 Liter)					
09.88 → 06.93	OM 602.962		246-082-005-002C	SWP-M-C	T1: 4
09.88 → 06.93	OM 602.962		246-082-008-013P	SWP-M-C	T1: 4
300 D (124.130) (80 kW 3.0 Liter)					
12.84 → 08.89	OM 603.912		246-082-005-002C	SWP-M-C	T1: 4
12.84 → 08.89	OM 603.912		246-082-008-013P	SWP-M-C	T1: 4
300 D 4-matic (124.330) (80 kW 3.0 Liter)					
09.86 → 08.92	OM 603.913		246-082-005-002C	SWP-M-C	T1: 4
09.86 → 08.92	OM 603.913		246-082-008-013P	SWP-M-C	T1: 4
300 D (124.130) (81 kW 3.0 Liter)					
06.90 → 06.93	OM 603.912		246-082-005-002C	SWP-M-C	T1: 4
300 D 4-matic (124.330) (83 kW 3.0 Liter)					
08.89 → 06.93	OM 603.913		246-082-005-002C	SWP-M-C	T1: 4
300 D (124.130) (83 kW 3.0 Liter)					
08.89 → 06.93	OM 603.912		246-082-005-002C	SWP-M-C	T1: 4



			VDO		
Datum	Motorcode	Fahrgestell Nr.	Artikel Nr.	Artikelbez.	Information

MERCEDES-BENZ**Stufenheck (W124)****300 Turbo-D (124.133) (105 kW | 3.0 Liter)**

09.86 → 09.88 OM 603.960 / OM 603.963 246-082-005-002C SWP-M-C T1: 4

09.87 → 09.88 OM 603.960 / OM 603.963 246-082-008-013P SWP-M-C T1: 4

300 Turbo-D 4-matic (124.333) (105 kW | 3.0 Liter)

09.86 → 09.88 OM 603.960 / OM 603.963 246-082-005-002C SWP-M-C T1: 4

300 Turbo-D (124.133) (108 kW | 3.0 Liter)

09.88 → 06.93 OM 603.960 246-082-005-002C SWP-M-C T1: 4

300 Turbo-D 4-matic (124.333) (108 kW | 3.0 Liter)

01.88 → 06.93 OM 603.963 246-082-005-002C SWP-M-C T1: 4

KOMBI Kombi (S124)**200 T (124.080) (77 kW | 2.0 Liter)**

01.86 → 05.90 M 102.922 246-082-005-002C SWP-M-C T1: 4

03.86 → 02.90 M 102.922 246-082-008-013P SWP-M-C T1: 4

200 T (124.080) (80 kW | 2.0 Liter)

09.85 → 08.89 M 102.922 246-082-005-002C SWP-M-C T1: 4

200 TE (124.081) (87 kW | 2.0 Liter)

09.88 → 08.92 M 102.963 246-082-005-002C SWP-M-C T1: 4

10.88 → 08.92 M 102.963 246-082-008-013P SWP-M-C T1: 4

200 TE (90 kW | 2.0 Liter)

09.88 → 12.89 M 102.962 246-082-005-002C SWP-M-C T1: 4

200 TE (124.079) (100 kW | 2.0 Liter)

10.92 → 06.93 M 111.940 246-082-005-002C SWP-M-C T1: 4

10.92 → 06.93 M 111.940 246-082-008-013P SWP-M-C T1: 4

220 TE (124.082) (110 kW | 2.2 Liter)

10.92 → 05.93 M 111.960 246-082-005-002C SWP-M-C T1: 4

10.92 → 05.93 M 111.960 246-082-008-013P SWP-M-C T1: 4

230 TE (124.083) (97 kW | 2.3 Liter)

09.85 → 08.92 M 102.982 246-082-005-002C SWP-M-C T1: 4

03.86 → 08.92 M 102.982 246-082-008-013P SWP-M-C T1: 4

230 TE (124.083) KAT (97 kW | 2.3 Liter)

06.89 → 08.92 M 102.982 246-082-005-002C SWP-M-C T1: 4

230 TE (124.083) (100 kW | 2.3 Liter)

09.85 → 08.92 M 102.982 246-082-005-002C SWP-M-C T1: 4

260 TE FGST. (118 kW | 2.6 Liter)

09.89 → 08.92 M 103.940 246-082-005-002C SWP-M-C T1: 4

260 TE FGST. (122 kW | 2.6 Liter)

09.85 → 12.89 M 103.940 246-082-005-002C SWP-M-C T1: 4

280 TE (124.088) (145 kW | 2.8 Liter)

10.92 → 06.93 M 104.942 246-082-005-002C SWP-M-C T1: 4





10.92 → 06.93 M 104.942 246-082-008-013P SWP-M-C T1: 4

300 TE (124.090) (132 kW | 3.0 Liter)

01.86 → 08.92 M 103.983 246-082-005-002C SWP-M-C T1: 4

03.86 → 08.92 M 103.983 246-082-008-013P SWP-M-C T1: 4



			VDO		
Datum	Motorcode	Fahrgestell Nr.	Artikel Nr.	Artikelbez.	Information

MERCEDES-BENZ

KOMBI Kombi (S124)

300 TE 4-matic (124.290) (132 kW 3.0 Liter)					
09.86 → 06.93	M 103.985		246-082-005-002C	SWP-M-C	T1: 4
11.86 → 06.93	M 103.985		246-082-008-013P	SWP-M-C	T1: 4
300 TE (124.090) (138 kW 3.0 Liter)					
01.86 → 12.89	M 103.983		246-082-005-002C	SWP-M-C	T1: 4
300 TE 4-matic (124.290) (138 kW 3.0 Liter)					
09.86 → 12.89	M 103.983		246-082-005-002C	SWP-M-C	T1: 4
300 TE-24 (124.091) (162 kW 3.0 Liter)					
09.89 → 08.92	M 104.980		246-082-005-002C	SWP-M-C	T1: 4
09.89 → 08.92	M 104.980		246-082-008-013P	SWP-M-C	T1: 4
320 TE (124.092) (162 kW 3.2 Liter)					
10.92 → 06.93	M 104.992		246-082-005-002C	SWP-M-C	T1: 4
10.92 → 06.93	M 104.992		246-082-008-013P	SWP-M-C	T1: 4
200 T D (124.180) (53 kW 2.0 Liter)					
09.85 → 08.91	OM 601.912		246-082-005-002C	SWP-M-C	T1: 4
03.86 → 08.91	OM 601.912		246-082-008-013P	SWP-M-C	T1: 4
200 T D (124.180) (55 kW 2.0 Liter)					
09.88 → 08.91	OM 601.912		246-082-005-002C	SWP-M-C	T1: 4
250 T D (124.185) (66 kW 2.5 Liter)					
09.85 → 06.93	OM 602.912		246-082-005-002C	SWP-M-C	T1: 4
03.86 → 06.93	OM 602.912		246-082-008-013P	SWP-M-C	T1: 4
250 T D (124.185) (69 kW 2.5 Liter)					
01.89 → 06.93	OM 602.912		246-082-005-002C	SWP-M-C	T1: 4
09.89 → 06.93	OM 602.912		246-082-008-013P	SWP-M-C	T1: 4
300 T D (124.190) (80 kW 3.0 Liter)					
09.86 → 06.93	OM 603.912		246-082-005-002C	SWP-M-C	T1: 4
09.86 → 06.93	OM 603.912		246-082-008-013P	SWP-M-C	T1: 4
300 T D (124.190) (81 kW 3.0 Liter)					
01.89 → 06.93	OM 603.912		246-082-005-002C	SWP-M-C	T1: 4
300 T D (124.190) (83 kW 3.0 Liter)					
01.89 → 06.93	OM 603.912		246-082-005-002C	SWP-M-C	T1: 4
300 T Turbo-D (105 kW 3.0 Liter)					
09.86 → 01.89	OM 603.963		246-082-005-002C	SWP-M-C	T1: 4
09.86 → 01.89	OM 603.963		246-082-008-013P	SWP-M-C	T1: 4
300 T Turbo-D 4-matic (124.393) (105 kW 3.0 Liter)					
09.86 → 01.89	OM 603.963		246-082-005-002C	SWP-M-C	T1: 4
300 T Turbo-D (124.193) (108 kW 3.0 Liter)					
01.89 → 06.93	OM 603.960		246-082-005-002C	SWP-M-C	T1: 4
01.89 → 06.93	OM 603.960		246-082-008-013P	SWP-M-C	T1: 4
300 T Turbo-D 4-matic (124.393) (108 kW 3.0 Liter)					
01.89 → 06.93	OM 603.960		246-082-005-002C	SWP-M-C	T1: 4



			VDO		
Datum	Motorcode	Fahrgestell Nr.	Artikel Nr.	Artikelbez.	Information

MERCEDES-BENZ**COUPE (C124)****220 CE (124.042) (110 kW | 2.2 Liter)**

10.92 → 05.93	M 111.960		246-082-005-002C	SWP-M-C	T1: 4
10.92 → 05.93	M 111.960		246-082-008-013P	SWP-M-C	T1: 4

230 CE (124.043) (97 kW | 2.3 Liter)

03.87 → 12.92	M 102.982		246-082-005-002C	SWP-M-C	T1: 4
03.87 → 12.92	M 102.982		246-082-008-013P	SWP-M-C	T1: 4

230 CE (124.043) KAT (97 kW | 2.3 Liter)

06.89 → 12.92	M 102.982		246-082-005-002C	SWP-M-C	T1: 4
---------------	-----------	--	------------------	---------	-------

230 CE (124.043) (100 kW | 2.3 Liter)

03.87 → 12.92	M 102.982		246-082-005-002C	SWP-M-C	T1: 4
---------------	-----------	--	------------------	---------	-------

300 CE (124.050) (132 kW | 3.0 Liter)

03.87 → 05.93	M 103.983		246-082-005-002C	SWP-M-C	T1: 4
---------------	-----------	--	------------------	---------	-------

300 CE (138 kW | 3.0 Liter)

03.87 → 12.89	M 103.983		246-082-005-002C	SWP-M-C	T1: 4
05.87 → 12.89	M 103.983		246-082-008-013P	SWP-M-C	T1: 4

300 CE-24 (124.051) (162 kW | 3.0 Liter)

09.89 → 12.92	M 104.980		246-082-005-002C	SWP-M-C	T1: 4
09.89 → 12.92	M 104.980		246-082-008-013P	SWP-M-C	T1: 4

320 CE (124.052) (162 kW | 3.2 Liter)

10.92 → 05.93	M 104.992		246-082-005-002C	SWP-M-C	T1: 4
10.92 → 05.93	M 104.992		246-082-008-013P	SWP-M-C	T1: 4

CABRIOLET (A124)**300 CE-24 (124.061) (162 kW | 3.0 Liter)**

04.92 → 06.93	M 104.980		246-082-005-002C	SWP-M-C	T1: 4
04.92 → 06.93	M 104.980		246-082-008-013P	SWP-M-C	T1: 4

E-KLASSE (W124)**E 200 (124.019) (100 kW | 2.0 Liter)**

06.93 → 06.95	M 111.940		246-082-005-002C	SWP-M-C	T1: 4
07.93 → 06.95	M 111.940		246-082-008-013P	SWP-M-C	T1: 4

E 220 (124.022) (110 kW | 2.2 Liter)

06.93 → 06.95	M 111.960		246-082-005-002C	SWP-M-C	T1: 4
07.93 → 06.95	M 111.960		246-082-008-013P	SWP-M-C	T1: 4

E 280 (124.028) (145 kW | 2.8 Liter)

06.93 → 06.95	M 104.942		246-082-005-002C	SWP-M-C	T1: 4
---------------	-----------	--	------------------	---------	-------

E 280 lang (124.029) (142 kW | 2.8 Liter)

06.93 → 06.95	M 104.942		246-082-005-002C	SWP-M-C	T1: 4
07.93 → 06.95	M 104.942		246-082-008-013P	SWP-M-C	T1: 4

E 300 4-matic (124.230) (132 kW | 3.0 Liter)

06.93 → 06.95	M 103.985		246-082-005-002C	SWP-M-C	T1: 4
07.93 → 06.95	M 103.985		246-082-008-013P	SWP-M-C	T1: 4



			VDO		
Datum	Motorcode	Fahrgestell Nr.	Artikel Nr.	Artikelbez.	Information

MERCEDES-BENZ

E-KLASSE (W124)

E 320 (124.032) (162 kW 3.2 Liter)					
06.93 → 06.95	M 104.992		246-082-005-002C	SWP-M-C	T1: 4
E 420 (124.034) (205 kW 4.2 Liter)					
06.93 → 06.95	M 119.975		246-082-005-002C	SWP-M-C	T1: 4
07.93 → 06.95	M 119.975		246-082-008-013P	SWP-M-C	T1: 4
E 500 (124.036) (235 kW 5.0 Liter)					
06.93 → 06.95	M 119.974		246-082-005-002C	SWP-M-C	T1: 4
07.93 → 06.95	M 119.974		246-082-008-013P	SWP-M-C	T1: 4
E 60 AMG (124.036) (280 kW 6.0 Liter)					
05.94 → 06.95			246-082-005-002C	SWP-M-C	T1: 4
E 200 D (124.120) (55 kW 2.0 Liter)					
06.93 → 06.95	OM 601.912		246-082-005-002C	SWP-M-C	T1: 4
07.93 → 06.95	OM 601.912		246-082-008-013P	SWP-M-C	T1: 4
E 250 D (124.126, 124.129) (83 kW 2.5 Liter)					
07.93 → 06.95	OM 605.911		246-082-005-002C	SWP-M-C	T1: 4
07.93 → 06.95	OM 605.911		246-082-008-013P	SWP-M-C	T1: 4
E 250 Turbo-D (124.128) (93 kW 2.5 Liter)					
06.93 → 06.95	OM 602.962		246-082-005-002C	SWP-M-C	T1: 4
07.93 → 06.95	OM 602.962		246-082-008-013P	SWP-M-C	T1: 4
E 300 D (124.131) (100 kW 3.0 Liter)					
07.93 → 06.95	OM 606.910		246-082-005-002C	SWP-M-C	T1: 4
07.93 → 06.95	OM 606.910		246-082-008-013P	SWP-M-C	T1: 4
E 300 Turbo-D (124.133) (108 kW 3.0 Liter)					
06.93 → 06.95	OM 603.960		246-082-005-002C	SWP-M-C	T1: 4
E 300 Turbo-D 4-matic (124.333) (108 kW 3.0 Liter)					
06.93 → 06.95	OM 603.963		246-082-005-002C	SWP-M-C	T1: 4
07.93 → 06.95	OM 603.963		246-082-008-013P	SWP-M-C	T1: 4

E-KLASSE Kombi (S124)

E 200 T (124.079) (100 kW 2.0 Liter)					
07.93 → 02.96	M 111.940		246-082-008-013P	SWP-M-C	T1: 4
E 220 T (124.082) (110 kW 2.2 Liter)					
07.93 → 02.96	M 111.960		246-082-008-013P	SWP-M-C	T1: 4
E 280 T (124.088) (142 kW 2.8 Liter)					
06.93 → 06.96	M 104.942		246-082-005-002C	SWP-M-C	T1: 4; T13: A124 869 00 21
06.93 → 06.96	M 104.942		246-082-008-013P	SWP-M-C	T1: 4; T13: A202 869 00 21
E 280 T (124.088) (145 kW 2.8 Liter)					
07.93 → 02.96	M 104.942		246-082-008-013P	SWP-M-C	T1: 4
E 300 T 4-matic (124.290) (132 kW 3.0 Liter)					
07.93 → 02.96	M 103.985		246-082-008-013P	SWP-M-C	T1: 4



			VDO		
Datum	Motorcode	Fahrgestell Nr.	Artikel Nr.	Artikelbez.	Information

MERCEDES-BENZ

E-KLASSE Kombi (S124)

E 300 TE-24 AMG (124.091) (162 kW | 3.0 Liter)

06.93 → 06.96	M 104.980		246-082-005-002C	SWP-M-C	T1: 4; T13: A124 869 00 21
06.93 → 06.96	M 104.980		246-082-008-013P	SWP-M-C	T1: 4; T13: A202 869 00 21

E 320 T (124.092) (162 kW | 3.2 Liter)

07.93 → 02.96	M 104.992		246-082-008-013P	SWP-M-C	T1: 4
---------------	-----------	--	------------------	---------	-------

E 36 T AMG (124.092) (200 kW | 3.6 Liter)

05.94 → 06.96	M 104.992 (AMG 3.6)		246-082-005-002C	SWP-M-C	T1: 4; T13: A124 869 00 21
05.94 → 06.96	M 104.992 (AMG 3.6)		246-082-008-013P	SWP-M-C	T1: 4; T13: A202 869 00 21

E 250 T D (124.186) (83 kW | 2.5 Liter)

07.93 → 02.96	OM 605.911		246-082-008-013P	SWP-M-C	T1: 4
---------------	------------	--	------------------	---------	-------

E 250 Turbo D (93 kW | 2.5 Liter)

06.93 → 06.96	OM 602.962		246-082-005-002C	SWP-M-C	T1: 4; T13: A124 869 00 21
06.93 → 06.96	OM 602.962		246-082-008-013P	SWP-M-C	T1: 4; T13: A202 869 00 21

E 300 T D (124.191) (100 kW | 3.0 Liter)

07.93 → 02.96	OM 606.910		246-082-008-013P	SWP-M-C	T1: 4
---------------	------------	--	------------------	---------	-------

E 300 T Turbo-D (124.193) (108 kW | 3.0 Liter)

07.93 → 02.96	OM 603.960		246-082-008-013P	SWP-M-C	T1: 4
---------------	------------	--	------------------	---------	-------

E 300 T Turbo-D 4-matic (124.393) (108 kW | 3.0 Liter)

07.93 → 02.96	OM 603.963		246-082-008-013P	SWP-M-C	T1: 4
---------------	------------	--	------------------	---------	-------

E-KLASSE Coupe (C124)

E 200 (124.040) (100 kW | 2.0 Liter)

06.93 → 06.97	M 111.940		246-082-005-002C	SWP-M-C	T1: 4
07.93 → 06.97	M 111.940		246-082-008-013P	SWP-M-C	T1: 4

E 220 (124.042) (110 kW | 2.2 Liter)

06.93 → 06.97	M 111.960		246-082-005-002C	SWP-M-C	T1: 4
07.93 → 06.97	M 111.960		246-082-008-013P	SWP-M-C	T1: 4

E 320 (124.052) (162 kW | 3.2 Liter)

06.93 → 06.97	M 104.992		246-082-005-002C	SWP-M-C	T1: 4
07.93 → 06.97	M 104.992		246-082-008-013P	SWP-M-C	T1: 4

E 36 AMG (124.052) (195 kW | 3.6 Liter)

06.93 → 04.95	M 104.992 (AMG 3.6)		246-082-005-002C	SWP-M-C	T1: 4
---------------	---------------------	--	------------------	---------	-------

E 36 AMG (124.052) (200 kW | 3.6 Liter)

05.94 → 06.97	M 104.992 (AMG 3.6)		246-082-005-002C	SWP-M-C	T1: 4
05.94 → 06.97	M 104.992 (AMG 3.6)		246-082-008-013P	SWP-M-C	T1: 4



			VDO		
Datum	Motorcode	Fahrgestell Nr.	Artikel Nr.	Artikelbez.	Information





MERCEDES-BENZ**E-KLASSE Cabriolet (A124)**

E 200 (124.060) (100 kW 2.0 Liter)					
06.93 → 03.98	M 111.940		246-082-005-002C	SWP-M-C	T1: 4
07.93 → 03.98	M 111.940		246-082-008-013P	SWP-M-C	T1: 4
E 220 (124.062) (110 kW 2.2 Liter)					
06.93 → 03.98	M 111.960		246-082-005-002C	SWP-M-C	T1: 4
07.93 → 03.98	M 111.960		246-082-008-013P	SWP-M-C	T1: 4
E 320 (124.066) (162 kW 3.2 Liter)					
06.93 → 03.98	M 104.992 / M 104.995		246-082-005-002C	SWP-M-C	T1: 4
07.93 → 03.98	M 104.992 / M 104.995		246-082-008-013P	SWP-M-C	T1: 4
E 36 AMG (124.066) (200 kW 3.6 Liter)					
05.94 → 03.98	M 104.992 (AMG 3.6)		246-082-005-002C	SWP-M-C	T1: 4
05.94 → 03.98	M 104.992 (AMG 3.6)		246-082-008-013P	SWP-M-C	T1: 4

E-KLASSE (W210)

E 200 (210.035) (100 kW 2.0 Liter)					
06.95 → 08.00	M 111.942	→ A394035	246-082-008-013P	SWP-M-C	T1: 4
06.95 → 08.00	M 111.942	A394036 →	246-082-008-025G	SWP-M-C	T1: 3
E 200 Kompressor (210.048) (120 kW 2.0 Liter)					
08.00 → 03.02	M 111.957		246-082-008-013P	SWP-M-C	T1: 4
08.00 → 03.02	M 111.957		246-082-008-025G	SWP-M-C	T1: 3; T13: A210 869 08 021
E 200 Kompressor (210.045) (137 kW 2.0 Liter)					
06.97 → 03.02	M 111.947		246-082-008-013P	SWP-M-C	T1: 4
06.97 → 03.02	M 111.947		246-082-008-025G	SWP-M-C	T1: 3; T13: A210 869 08 21
E 230 (210.037) (110 kW 2.3 Liter)					
06.95 → 06.97	M 111.970	→ A394035	246-082-008-013P	SWP-M-C	T1: 4
06.95 → 06.97	M 111.970	A394036 →	246-082-008-025G	SWP-M-C	T1: 3
E 240 (210.061) (125 kW 2.4 Liter)					
06.97 → 06.99	M 112.911		246-082-008-025G	SWP-M-C	T1: 3
E 240 (210.062) (125 kW 2.6 Liter)					
08.00 → 03.02	M 112.914		246-082-008-013P	SWP-M-C	T1: 4
08.00 → 03.02	M 112.914		246-082-008-025G	SWP-M-C	T1: 3; T13: A210 869 08 021
E 280 (210.053) (142 kW 2.8 Liter)					
01.96 → 06.97	M 104.945		246-082-008-025G	SWP-M-C	T1: 3
E 280 (210.063) (150 kW 2.8 Liter)					
12.96 → 03.02	M 112.921		246-082-008-013P	SWP-M-C	T1: 4
12.96 → 03.02	M 112.921		246-082-008-025G	SWP-M-C	T1: 3; T13: A210 869 08 21
E 280 4-matic (210.081) (150 kW 2.8 Liter)					
12.96 → 03.02	M 112.921		246-082-008-013P	SWP-M-C	T1: 4
12.96 → 03.02	M 112.921		246-082-008-025G	SWP-M-C	T1: 3; T13: A210 869 08 21



			VDO		
Datum	Motorcode	Fahrgestell Nr.	Artikel Nr.	Artikelbez.	Information

MERCEDES-BENZ**E-KLASSE (W210)****E 320 (210.055) (162 kW | 3.2 Liter)**

06.95 → 09.95 M 104.992 246-082-008-013P SWP-M-C T1: 4

E 320 (210.065) (165 kW | 3.2 Liter)

06.97 → 03.02 M 112.941 246-082-008-013P SWP-M-C T1: 4

06.97 → 03.02 M 112.941 246-082-008-025G SWP-M-C T1: 3; T13:
A210 869 08 21**E 320 4-matic (210.082) (165 kW | 3.2 Liter)**

06.97 → 03.02 M 112.941 246-082-008-013P SWP-M-C T1: 4

06.97 → 03.02 M 112.941 246-082-008-025G SWP-M-C T1: 3; T13:
A210 869 08 21**E 420 (210.072) (205 kW | 4.2 Liter)**

01.96 → 06.97 M 119.985 246-082-008-013P SWP-M-C T1: 4

E 430 (210.070) (205 kW | 4.3 Liter)

06.97 → 03.02 M 113.940 246-082-008-025G SWP-M-C T1: 3

E 430 4-matic (210.083) (205 kW | 4.3 Liter)

05.99 → 03.02 M 113.940 246-082-008-013P SWP-M-C T1: 4

05.99 → 03.02 M 113.940 246-082-008-025G SWP-M-C T1: 3; T13:
A210 869 08 021**E 50 AMG (210.072) (255 kW | 5.0 Liter)**

03.96 → 08.97 M 119.985 (AMG 5.0) 246-082-008-013P SWP-M-C T1: 4

E 55 AMG (210.074) (260 kW | 5.4 Liter)

09.97 → 03.02 M 113.980 246-082-008-025G SWP-M-C T1: 3

E 55 AMG 4-matic (210.083) (260 kW | 5.4 Liter)

03.01 → 03.02 M 113.980 246-082-008-013P SWP-M-C T1: 4

03.01 → 03.02 M 113.980 246-082-008-025G SWP-M-C T1: 3; T13:
A210 869 08 021**E 200 D (210.003) (65 kW | 2.0 Liter)**

01.96 → 03.02 OM 604.917 → A394035 246-082-008-013P SWP-M-C T1: 4

01.96 → 03.02 OM 604.917 A394036 → 246-082-008-025G SWP-M-C T1: 3

E 200 CDI (210.007) (75 kW | 2.2 Liter)

06.98 → 03.02 OM 611.961 246-082-008-013P SWP-M-C T1: 4

06.98 → 03.02 OM 611.961 246-082-008-025G SWP-M-C T1: 3; T13:
A210 869 08 21**E 200 CDI (210.007) (85 kW | 2.2 Liter)**

07.99 → 03.02 OM 611.961 246-082-008-013P SWP-M-C T1: 4

07.99 → 03.02 OM 611.961 246-082-008-025G SWP-M-C T1: 3; T13:
A210 869 08 21**E 220 CDI (210.006) (92 kW | 2.2 Liter)**

06.98 → 07.99 OM 611.961 246-082-008-013P SWP-M-C T1: 4

06.98 → 07.99 OM 611.961 246-082-008-025G SWP-M-C T1: 3

E 220 CDI (210.006) (105 kW | 2.2 Liter)

07.99 → 03.02 OM 611.961 246-082-008-013P SWP-M-C T1: 4

07.99 → 03.02 OM 611.961 246-082-008-025G SWP-M-C T1: 3; T13:
A210 869 08 21



			VDO		
Datum	Motorcode	Fahrgestell Nr.	Artikel Nr.	Artikelbez.	Information

MERCEDES-BENZ

E-KLASSE (W210)

E 220 D (55 kW 2.2 Liter)					
05.96 → 03.02	OM 604.912	→ A394035	246-082-008-013P	SWP-M-C	T1: 4
05.96 → 03.02	OM 604.912	A394036 →	246-082-008-025G	SWP-M-C	T1: 3
E 220 D (210.004) (70 kW 2.2 Liter)					
06.95 → 07.99	OM 604.912		246-082-008-013P	SWP-M-C	T1: 4
06.95 → 07.99	OM 604.912		246-082-008-025G	SWP-M-C	T1: 3; T13: A210 869 08 21
E 250 D (210.010) (83 kW 2.5 Liter)					
06.95 → 07.99	OM 605.912	→ A394035	246-082-008-013P	SWP-M-C	T1: 4
06.95 → 07.99	OM 605.912	A394036 →	246-082-008-025G	SWP-M-C	T1: 3
E 250 Turbo-D (210.015) (110 kW 2.5 Liter)					
06.97 → 07.99	OM 605.962		246-082-008-013P	SWP-M-C	T1: 4
06.97 → 07.99	OM 605.962		246-082-008-025G	SWP-M-C	T1: 3; T13: A210 869 08 21
E 270 CDI (210.016) (125 kW 2.7 Liter)					
07.99 → 03.02	OM 612.961		246-082-008-025G	SWP-M-C	T1: 3
E 290 Turbo-D (210.017) (95 kW 2.9 Liter)					
03.96 → 07.99	OM 602.982	→ A394035	246-082-008-013P	SWP-M-C	T1: 4
03.96 → 07.99	OM 602.982	A394036 →	246-082-008-025G	SWP-M-C	T1: 3
E 300 D (210.020) (100 kW 3.0 Liter)					
06.95 → 06.97	OM 606.912		246-082-008-013P	SWP-M-C	T1: 4
E 300 Turbo-D (210.025) (130 kW 3.0 Liter)					
12.96 → 07.99	OM 606.962		246-082-008-025G	SWP-M-C	T1: 3
E 320 CDI (210.026) (145 kW 3.2 Liter)					
07.99 → 03.02	OM 613.961		246-082-008-025G	SWP-M-C	T1: 3

E-KLASSE Kombi (S210)

E 250 T D (210.210) (83 kW 2.5 Liter)					
06.96 → 07.99	OM 605.912		246-082-008-025G	SWP-M-C	T1: 3

E-KLASSE (W211)

E 200 Kompressor (211.042) (120 kW 1.8 Liter)					
11.02 →	M 271.941		246-082-008-025G	SWP-M-C	T1: 3
E200 NGT (120 kW 1.8 Liter)					
03.04 →	M 271.941		246-082-008-025G	SWP-M-C	T1: 3
E 200 CGI (125 kW 1.8 Liter)					
11.02 →	M 271.946		246-082-008-025G	SWP-M-C	T1: 3
E 240 (211.061) (130 kW 2.6 Liter)					
03.02 →	M 112.913 / M 112.917		246-082-008-025G	SWP-M-C	T1: 3
E 240 4-matic (211.080) (130 kW 2.4 Liter)					
03.03 →	M 112.917		246-082-008-025G	SWP-M-C	T1: 3
E 280 (211.054) (170 kW 3.0 Liter)					
03.05 →	M 272.943		246-082-008-025G	SWP-M-C	T1: 3



			VDO		
Datum	Motorcode	Fahrgestell Nr.	Artikel Nr.	Artikelbez.	Information





MERCEDES-BENZ**E-KLASSE (W211)**

E 320 (211.065) (165 kW 3.2 Liter)					
03.02 →	M 112.949		246-082-008-025G	SWP-M-C	T1: 3
E 320 4-matic (211.082) (165 kW 3.2 Liter)					
03.03 →	M 112.954		246-082-008-025G	SWP-M-C	T1: 3
E 350 (211.056) (200 kW 3.5 Liter)					
03.05 →	M 272.964		246-082-008-025G	SWP-M-C	T1: 3
E 500 (211.070) (225 kW 5.0 Liter)					
03.02 →	M 113.967		246-082-008-025G	SWP-M-C	T1: 3
E 500 4-matic (211.083) (225 kW 5.0 Liter)					
10.03 →	M 113.969		246-082-008-025G	SWP-M-C	T1: 3
E 55 AMG Kompressor (211.076) (350 kW 5.5 Liter)					
10.02 →	M 113.990		246-082-008-025G	SWP-M-C	T1: 3
E 200 CDI (211.004) (75 kW 2.2 Liter)					
07.02 →	OM 646.951		246-082-008-025G	SWP-M-C	T1: 3
E 200 CDI (211.004) (90 kW 2.2 Liter)					
07.02 →	OM 646.951		246-082-008-025G	SWP-M-C	T1: 3
E 220 CDI (211.006) (110 kW 2.1 Liter)					
03.02 →	OM 646.961		246-082-008-025G	SWP-M-C	T1: 3
E 270 CDI (211.016) (130 kW 2.7 Liter)					
03.02 →	OM 647.961		246-082-008-025G	SWP-M-C	T1: 3
E 280 CDI (211.023) (130 kW 3.2 Liter)					
05.04 →	OM 648.961		246-082-008-025G	SWP-M-C	T1: 3
E 280 CDI (211.020) (140 kW 3.0 Liter)					
03.05 →	OM 642.920		246-082-008-025G	SWP-M-C	T1: 3
E 280 CDI 4-matic (140 kW 3.0 Liter)					
03.05 →	OM 642.921		246-082-008-025G	SWP-M-C	T1: 3
E 320 CDI (211.026) (150 kW 3.2 Liter)					
11.02 →	OM 648.961		246-082-008-025G	SWP-M-C	T1: 3
E 320 CDI (211.022) (165 kW 3.0 Liter)					
03.05 →	OM 642.920		246-082-008-025G	SWP-M-C	T1: 3
E 400 CDI (211.028) (191 kW 4.0 Liter)					
02.03 →	OM 628.961		246-082-008-025G	SWP-M-C	T1: 3

E-KLASSE Kombi (S211)

E 200 T Kompressor (211.242) (120 kW 1.8 Liter)					
03.03 →	M 271.941		246-082-008-025G	SWP-M-C	T1: 3
E 240 T (211.261) (130 kW 2.6 Liter)					
03.03 →	M 112.913		246-082-008-025G	SWP-M-C	T1: 3
E 240 T 4-matic (211.280) (130 kW 2.6 Liter)					
07.03 →	M 112.917		246-082-008-025G	SWP-M-C	T1: 3
E 280 T (211.254) (170 kW 3.0 Liter)					
03.05 →	M 272.943		246-082-008-025G	SWP-M-C	T1: 3
E 280 T 4-matic (170 kW 3.0 Liter)					
03.05 →	M 272.943		246-082-008-025G	SWP-M-C	T1: 3



			VDO		
Datum	Motorcode	Fahrgestell Nr.	Artikel Nr.	Artikelbez.	Information

MERCEDES-BENZ

E-KLASSE Kombi (S211)

E 320 T (211.265) (165 kW 3.2 Liter)					
03.03 →	M 112.949		246-082-008-025G	SWP-M-C	T1: 3
E 320 T 4-matic (211.282) (165 kW 3.2 Liter)					
07.03 →	M 112.954		246-082-008-025G	SWP-M-C	T1: 3
E 350 T (211.287) (200 kW 3.5 Liter)					
03.05 →	M 272.964		246-082-008-025G	SWP-M-C	T1: 3
E 500 T (211.270) (225 kW 5.0 Liter)					
10.03 →	M 113.967		246-082-008-025G	SWP-M-C	T1: 3
E 500 T 4-matic (211.283) (225 kW 5.0 Liter)					
10.03 →	M 113.969		246-082-008-025G	SWP-M-C	T1: 3
E 55 T AMG Kompressor (211.276) (350 kW 5.4 Liter)					
07.03 →	M 113.990		246-082-008-025G	SWP-M-C	T1: 3
E 220 T CDI (211.206) (110 kW 2.1 Liter)					
03.03 →	OM 646.961		246-082-008-025G	SWP-M-C	T1: 3
E 270 T CDI (211.216) (130 kW 2.7 Liter)					
03.03 →	OM 647.961		246-082-008-025G	SWP-M-C	T1: 3
E 280 T CDI (211.223) (130 kW 3.2 Liter)					
05.04 →	OM 648.961		246-082-008-025G	SWP-M-C	T1: 3
E 280 T CDI (211.220) (140 kW 3.0 Liter)					
03.05 →	OM 642.920		246-082-008-025G	SWP-M-C	T1: 3
E 280 T CDI 4-matic (140 kW 3.0 Liter)					
03.05 →	OM 642.921		246-082-008-025G	SWP-M-C	T1: 3
E 320 T CDI (211.226) (150 kW 3.2 Liter)					
03.03 →	OM 648.961		246-082-008-025G	SWP-M-C	T1: 3
E 320 T CDI (211.222) (165 kW 3.0 Liter)					
03.05 →	OM 642.920		246-082-008-025G	SWP-M-C	T1: 3

S-KLASSE Stufenheck (W108, W109)

250 S (108.012) (96 kW 2.5 Liter)					
01.66 → 12.69	M 108.920		246-069-026-001G	N	
250 SE (108.014) (110 kW 2.5 Liter)					
01.66 → 12.67	M 129.980		246-075-017-002C	SWP-M-G	T1: 4; T2: C
280 S (108.016) (103 kW 2.7 Liter)					
10.67 → 07.72	M 130.920		246-069-026-001G	N	
280 SE,SEL (108.018, 108.019) (118 kW 2.7 Liter)					
01.68 → 08.72	M 130.980		246-069-026-001G	N	
300 SEL (109.016) (118 kW 2.7 Liter)					
01.68 → 08.72	M 130.981		246-069-026-001G	N	
300 SEL 3.5 (109.056) (147 kW 3.5 Liter)					
01.70 → 07.72	M 116.981		246-069-026-001G	N	
280 SE,SEL 3.5 (108.057, 108.058) (147 kW 3.5 Liter)					
03.71 → 08.72	M 116.980		246-069-026-001G	N	
300 SEL 6.3 (109.018) (184 kW 6.3 Liter)					
03.68 → 08.72	M 100.981		246-069-026-001G	N	



			VDO		
Datum	Motorcode	Fahrgestell Nr.	Artikel Nr.	Artikelbez.	Information

MERCEDES-BENZ





S-KLASSE (W116)

280 S (116.020) (115 kW 2.7 Liter)					
08.72 → 07.80	M 110.922		246-075-017-002C	SWP-M-G	T1: 4; T2: C
280 S (116.020) (118 kW 2.7 Liter)					
08.72 → 07.80	M 110.922		246-075-017-002C	SWP-M-G	T1: 4; T2: C
280 SE,SEL (116.024) (130 kW 2.7 Liter)					
08.72 → 07.80	M 110.985		246-075-017-002C	SWP-M-G	T1: 4; T2: C
280 SE,SEL (116.024) (136 kW 2.7 Liter)					
08.72 → 07.80	M 110.983 / M 110.985		246-075-017-002C	SWP-M-G	T1: 4; T2: C
350 SE,SEL (116.028, 116.029) (143 kW 3.5 Liter)					
03.76 → 03.80	M 116.985		246-075-017-002C	SWP-M-G	T1: 4; T2: C
350 SE,SEL (116.028, 116.029) (147 kW 3.5 Liter)					
08.72 → 02.76	M 116.983		246-075-017-002C	SWP-M-G	T1: 4; T2: C
350 SE,SEL (116.028, 116.029) (151 kW 3.5 Liter)					
03.76 → 03.80	M 116.985		246-075-017-002C	SWP-M-G	T1: 4; T2: C
450 SE,SEL (116.033) (160 kW 4.5 Liter)					
12.75 → 04.80	M 117.985 / M 117.986		246-075-017-002C	SWP-M-G	T1: 4; T2: C
12.75 → 04.80	M 117.985 / M 117.986		246-075-021-007C	SWP-M-G	T1: 1; T2: C; T13: A000 869 30 21
450 SE,SEL (116.032) (165 kW 4.5 Liter)					
01.73 → 04.80	M 117.983 / M 117.986		246-075-017-002C	SWP-M-G	T1: 4; T2: C
01.73 → 04.80	M 117.983 / M 117.986		246-075-021-007C	SWP-M-G	T1: 1; T2: C; T13: A000 869 30 21
450 SEL 6.9 (116.036) (210 kW 6.8 Liter)					
07.75 → 03.80	M 100.985		246-075-017-002C	SWP-M-G	T1: 4; T2: C
07.75 → 03.80	M 100.985		246-075-021-007C	SWP-M-G	T1: 1; T2: C; T13: A000 869 30 21

S-KLASSE (W126)

260 SE (126.020) (118 kW 2.5 Liter)					
09.85 → 06.91	M 103.941		246-082-008-013P	SWP-M-C	T1: 4
260 SE (126.020) (122 kW 2.5 Liter)					
09.85 → 06.91	M 103.941		246-082-008-013P	SWP-M-C	T1: 4
280 S (126.021) (115 kW 2.7 Liter)					
12.79 → 07.85	M 110.924 / M 110.926		246-080-003-006D	N-H	
12.79 → 07.85	M 110.924 / M 110.926		246-082-005-002C	SWP-M-C	T1: 4
12.79 → 07.85	M 110.924 / M 110.926		246-082-008-013P	SWP-M-C	T1: 4
280 SE,SEL (126.022, 126.023) (136 kW 2.7 Liter)					
10.79 → 07.85	M 110.987 / M 110.989		246-082-008-013P	SWP-M-C	T1: 4
300 SE,SEL (126.024, 126.025) (132 kW 3.0 Liter)					
01.86 → 06.91	M 103.981		246-082-008-013P	SWP-M-C	T1: 4
300 SE,SEL (126.024, 126.025) (138 kW 3.0 Liter)					
09.85 → 12.89	M 103.981		246-082-008-013P	SWP-M-C	T1: 4
380 SE,SEL (126.032) (150 kW 3.8 Liter)					
01.80 → 08.85	M 116.963		246-082-008-013P	SWP-M-C	T1: 4



			VDO		
Datum	Motorcode	Fahrgestell Nr.	Artikel Nr.	Artikelbez.	Information

MERCEDES-BENZ





S-KLASSE (W126)

380 SE,SEL (126.032) (160 kW 3.8 Liter)					
12.85 → 12.86	M 116.961		246-082-008-013P	SWP-M-C	T1: 4
420 SE,SEL (126.034) (150 kW 4.1 Liter)					
10.85 → 06.91	M 116.965		246-082-008-013P	SWP-M-C	T1: 4
420 SE,SEL (126.034) (160 kW 4.1 Liter)					
10.85 → 12.87	M 116.965		246-082-008-013P	SWP-M-C	T1: 4
420 SE,SEL (165 kW 4.1 Liter)					
10.85 → 06.91	M 116.965		246-082-008-013P	SWP-M-C	T1: 4
420 SE,SEL (170 kW 4.1 Liter)					
10.85 → 12.87	M 116.965		246-082-008-013P	SWP-M-C	T1: 4
500 SE,SEL (126.036) (164 kW 4.9 Liter)					
09.85 → 06.91	M 117.965		246-082-008-013P	SWP-M-C	T1: 4
500 SE,SEL (126.036) (170 kW 4.9 Liter)					
12.79 → 08.85	M 117.961 / M 117.963		246-082-008-013P	SWP-M-C	T1: 4
500 SE,SEL (126.036) (177 kW 4.9 Liter)					
12.79 → 08.85	M 117.961 / M 117.963		246-082-008-013P	SWP-M-C	T1: 4
500 SE,SEL (126.036) (180 kW 4.9 Liter)					
09.85 → 06.91	M 117.965		246-082-008-013P	SWP-M-C	T1: 4
500 SE,SEL (185 kW 4.9 Liter)					
09.87 → 06.91	M 117.965		246-082-008-013P	SWP-M-C	T1: 4
500 SE,SEL KAT (185 kW 5.0 Liter)					
06.89 → 06.91	M 117.965		246-082-008-013P	SWP-M-C	T1: 4
500 SE,SEL (195 kW 4.9 Liter)					
09.87 → 06.91	M 117.965		246-082-008-013P	SWP-M-C	T1: 4
560 SE,SEL (126.038) (178 kW 5.5 Liter)					
10.85 → 06.91	M 117.968		246-082-005-002C	SWP-M-C	T1: 4
10.85 → 06.91	M 117.968		246-082-008-013P	SWP-M-C	T1: 4
560 SE,SEL (126.038) (200 kW 5.5 Liter)					
10.85 → 12.87	M 117.968		246-082-005-002C	SWP-M-C	T1: 4
560 SE,SEL (205 kW 5.5 Liter)					
08.87 → 06.91	M 117.968		246-082-005-002C	SWP-M-C	T1: 4
560 SE,SEL (220 kW 5.5 Liter)					
10.85 → 06.91	M 117.968		246-082-005-002C	SWP-M-C	T1: 4

S-KLASSE Coupe (C126)

380 SEC (126.043) (150 kW 3.8 Liter)					
10.81 → 07.85	M 116.963		246-082-008-013P	SWP-M-C	T1: 4
420 SEC (126.046) (150 kW 4.1 Liter)					
10.85 → 06.91	M 116.965		246-082-008-013P	SWP-M-C	T1: 4
500 SEC (126.044) (170 kW 4.9 Liter)					
10.81 → 08.85	M 117.963		246-082-008-013P	SWP-M-C	T1: 4
500 SEC (195 kW 5.0 Liter)					
09.85 → 07.89	M 117.965		246-082-008-013P	SWP-M-C	T1: 4



			VDO		
Datum	Motorcode	Fahrgestell Nr.	Artikel Nr.	Artikelbez.	Information

MERCEDES-BENZ

S-KLASSE Coupe (C126)

560 SEC (126.045) (178 kW | 5.5 Liter)

10.85 → 06.91	M 117.968		246-082-008-013P	SWP-M-C	T1: 4
---------------	-----------	--	------------------	---------	-------

560 SEC (126.045) (205 kW | 5.5 Liter)

10.85 → 06.91	M 117.968		246-082-005-002C	SWP-M-C	T1: 4
---------------	-----------	--	------------------	---------	-------

560 SEC (126.045) (220 kW | 5.5 Liter)

10.85 → 12.89	M 117.968		246-082-005-002C	SWP-M-C	T1: 4
---------------	-----------	--	------------------	---------	-------

S-KLASSE (W140)

S 280 (140.028) (142 kW | 2.8 Liter)

02.93 → 10.98	M 104.944		246-082-008-013P	SWP-M-C	T1: 4
---------------	-----------	--	------------------	---------	-------

02.93 → 10.98	M 104.944		246-082-008-025G	SWP-M-C	T1: 3; T13: A210 869 08 21
---------------	-----------	--	------------------	---------	-------------------------------

300 SE 2.8 (140.028) (145 kW | 2.8 Liter)

01.93 → 10.98	M 104.944		246-082-008-013P	SWP-M-C	T1: 4
---------------	-----------	--	------------------	---------	-------

01.93 → 10.98	M 104.944		246-082-008-025G	SWP-M-C	T1: 3; T13: A210 869 08 21
---------------	-----------	--	------------------	---------	-------------------------------

300 SE,SEL/S320 (140.032, 140.033) (170 kW | 3.2 Liter)

03.91 → 10.98	M 104.990 / M 104.994		246-082-005-002C	SWP-M-C	T1: 4
---------------	-----------------------	--	------------------	---------	-------

03.91 → 06.93	M 104.990 / M 104.994	→ A328810	246-082-008-013P	SWP-M-C	T1: 4
---------------	-----------------------	-----------	------------------	---------	-------

03.91 → 10.98	M 104.990 / M 104.994	A328811 →	246-082-008-025G	SWP-M-C	T1: 3
---------------	-----------------------	-----------	------------------	---------	-------

S 420 (140.042) (205 kW | 4.2 Liter)

07.93 → 08.98	M 119.971	→ A328810	246-082-008-013P	SWP-M-C	T1: 4
---------------	-----------	-----------	------------------	---------	-------

01.93 → 10.98	M 119.971	A328811 →	246-082-008-025G	SWP-M-C	T1: 3
---------------	-----------	-----------	------------------	---------	-------

400 SE,SEL/S420 (140.042, 140.043) (210 kW | 4.2 Liter)

03.91 → 06.93	M 119.971	→ A328810	246-082-008-013P	SWP-M-C	T1: 4
---------------	-----------	-----------	------------------	---------	-------

02.91 → 10.98	M 119.971	A328811 →	246-082-008-025G	SWP-M-C	T1: 3
---------------	-----------	-----------	------------------	---------	-------

S 500 (140.050, 140.051) (235 kW | 5.0 Liter)

07.93 → 08.98	M 119.970	→ A328810	246-082-008-013P	SWP-M-C	T1: 4
---------------	-----------	-----------	------------------	---------	-------

01.93 → 10.98	M 119.970	A328811 →	246-082-008-025G	SWP-M-C	T1: 3
---------------	-----------	-----------	------------------	---------	-------

500 SE,SEL (140.050, 140.051) (240 kW | 5.0 Liter)

03.91 → 06.93	M 119.970	→ A328810	246-082-008-013P	SWP-M-C	T1: 4
---------------	-----------	-----------	------------------	---------	-------

02.91 → 10.98	M 119.970	A328811 →	246-082-008-025G	SWP-M-C	T1: 3
---------------	-----------	-----------	------------------	---------	-------

S 600 (140.056, 140.057) (290 kW | 6.0 Liter)

07.93 → 08.98	M 120.980	→ A328810	246-082-008-013P	SWP-M-C	T1: 4
---------------	-----------	-----------	------------------	---------	-------

01.93 → 10.98	M 120.980	A328811 →	246-082-008-025G	SWP-M-C	T1: 3
---------------	-----------	-----------	------------------	---------	-------

600 SE,SEL (140.056, 140.057) (300 kW | 6.0 Liter)

04.91 → 12.92	M 120.980	→ A328810	246-082-008-013P	SWP-M-C	T1: 4
---------------	-----------	-----------	------------------	---------	-------

04.91 → 12.92	M 120.980	A328811 →	246-082-008-025G	SWP-M-C	T1: 3
---------------	-----------	-----------	------------------	---------	-------

S 300 Turbo-D (140.135) (130 kW | 3.0 Liter)

08.96 → 08.98	OM 606.961	→ A328810	246-082-008-013P	SWP-M-C	T1: 4
---------------	------------	-----------	------------------	---------	-------

05.96 → 10.98	OM 606.961	A328811 →	246-082-008-025G	SWP-M-C	T1: 3
---------------	------------	-----------	------------------	---------	-------

S 350 Turbo-D (140.134) (110 kW | 3.4 Liter)

07.93 → 08.98	OM 603.971	→ A328810	246-082-008-013P	SWP-M-C	T1: 4
---------------	------------	-----------	------------------	---------	-------

01.93 → 10.98	OM 603.971	A328811 →	246-082-008-025G	SWP-M-C	T1: 3
---------------	------------	-----------	------------------	---------	-------



			VDO		
Datum	Motorcode	Fahrgestell Nr.	Artikel Nr.	Artikelbez.	Information

MERCEDES-BENZ

S-KLASSE Coupe (C140)

SEC/CL 420 (140.063) (205 kW 4.2 Liter)					
10.94 → 07.96	M 119.971	→ A328810	246-082-008-013P	SWP-M-C	T1: 4
07.96 → 02.99	M 119.971	A328811 →	246-082-008-025G	SWP-M-C	T1: 3
SEC/CL 500 (140.070) (235 kW 5.0 Liter)					
10.92 → 07.96	M 119.970	→ A328810	246-082-008-013P	SWP-M-C	T1: 4
06.93 → 02.99	M 119.970	A328811 →	246-082-008-025G	SWP-M-C	T1: 3
SEC/CL 600 (140.076) (290 kW 6.0 Liter)					
09.92 → 07.96	M 120.980	→ A328810	246-082-008-013P	SWP-M-C	T1: 4
06.93 → 02.99	M 120.980	A328811 →	246-082-008-025G	SWP-M-C	T1: 3

S-KLASSE (W220)

S 280 (220.063, 220.163) (150 kW 2.8 Liter)					
10.98 → 08.05	M 112.922	A328811 →	246-082-008-025G	SWP-M-C	T1: 3
S 320 (220.065, 220.165) (165 kW 3.2 Liter)					
10.98 → 08.05	M 112.944	A328811 →	246-082-008-025G	SWP-M-C	T1: 3
S 350 (220.067, 220.167) (180 kW 3.7 Liter)					
09.02 → 08.05	M 112.972		246-082-008-025G	SWP-M-C	T1: 3
S 350 4-matic (220.087, 220.187) (180 kW 3.7 Liter)					
06.03 → 08.05	M 112.975		246-082-008-025G	SWP-M-C	T1: 3
S 430 (220.070, 220.170) (205 kW 4.3 Liter)					
10.98 → 08.05	M 113.941		246-082-008-025G	SWP-M-C	T1: 3
S 430 4-matic (220.083, 220.183) (205 kW 4.3 Liter)					
09.02 → 08.05	M 113.948		246-075-024-002C	SWP-M-G	T1: 1; T2: C; T13: A000 869 31 21
09.02 → 08.05	M 113.948		246-082-008-025G	SWP-M-C	T1: 3
S 500 (220.075, 220.175, 220.875) (225 kW 5.0 Liter)					
10.98 → 08.05	M 113.960		246-082-008-025G	SWP-M-C	T1: 3
S 500 4-matic (220.084, 220.184) (225 kW 5.0 Liter)					
09.02 → 08.05	M 113.966		246-082-008-025G	SWP-M-C	T1: 3
S 55 AMG (220.073, 220.173) (265 kW 5.5 Liter)					
01.00 → 08.05	M 113.986		246-082-008-025G	SWP-M-C	T1: 3
S 55 AMG Kompressor (220.074, 220.174) (368 kW 5.5 Liter)					
06.02 → 08.05	M 113.991		246-082-008-025G	SWP-M-C	T1: 3
S 600 (220.176) (368 kW 5.5 Liter)					
09.02 → 08.05	M 275.950		246-082-008-025G	SWP-M-C	T1: 3
S 600 (220.878, 220.178) (270 kW 5.8 Liter)					
01.00 → 08.05	M 137.970		246-082-008-025G	SWP-M-C	T1: 3
S 63 AMG (326 kW 6.3 Liter)					
09.01 → 08.05			246-082-008-025G	SWP-M-C	T1: 3
S 65 AMG (220.179) (450 kW 6.0 Liter)					
03.04 → 08.05	M 275.980		246-082-008-025G	SWP-M-C	T1: 3
S 320 CDI (220.026, 220.126) (145 kW 3.2 Liter)					
01.00 → 09.02	OM 613.960		246-082-008-025G	SWP-M-C	T1: 3



			VDO		
Datum	Motorcode	Fahrgestell Nr.	Artikel Nr.	Artikelbez.	Information

MERCEDES-BENZ

S-KLASSE (W220)

S 320 CDI (220.025, 220.125) (150 kW | 3.2 Liter)

09.02 → 08.05	OM 648.960		246-082-008-025G	SWP-M-C	T1: 3
---------------	------------	--	------------------	---------	-------

S 400 CDI (220.028, 220.128) (184 kW | 4.0 Liter)

06.00 → 08.05	OM 628.960		246-082-008-025G	SWP-M-C	T1: 3
---------------	------------	--	------------------	---------	-------

S 400 CDI (191 kW | 4.0 Liter)

06.03 → 08.05	OM 628.960		246-082-008-025G	SWP-M-C	T1: 3
---------------	------------	--	------------------	---------	-------

S-KLASSE Coupe (C215)

CL 500 (215.375) (225 kW | 5.0 Liter)

03.99 → 07.99	M 113.960	→ A328810	246-082-008-013P	SWP-M-C	T1: 4
---------------	-----------	-----------	------------------	---------	-------

07.99 →	M 113.960	A328811 →	246-082-008-025G	SWP-M-C	T1: 3
---------	-----------	-----------	------------------	---------	-------

CL 600 (215.378) (270 kW | 5.8 Liter)

03.99 → 07.99	M 137.970	→ A328810	246-082-008-013P	SWP-M-C	T1: 4
---------------	-----------	-----------	------------------	---------	-------

07.99 →	M 137.970	A328811 →	246-082-008-025G	SWP-M-C	T1: 3
---------	-----------	-----------	------------------	---------	-------

CLS (C219)

350 (219.356) (200 kW | 3.5 Liter)

10.04 →	M 272.964		246-082-008-025G	SWP-M-C	T1: 3
---------	-----------	--	------------------	---------	-------

500 (219.375) (225 kW | 5.0 Liter)

10.04 →	M 113.967		246-082-008-025G	SWP-M-C	T1: 3
---------	-----------	--	------------------	---------	-------

CLS 55 AMG (219.376) (350 kW | 5.4 Liter)

01.05 →	M 113.990		246-082-008-025G	SWP-M-C	T1: 3
---------	-----------	--	------------------	---------	-------

320 CDI (165 kW | 3.2 Liter)

01.05 →			246-082-008-025G	SWP-M-C	T1: 3
---------	--	--	------------------	---------	-------

SL Coupe (C107)

280 SLC (107.022) (130 kW | 2.7 Liter)

06.76 → 08.81	M 110.982 / M 110.986 / M 110.990		246-082-008-013P	SWP-M-C	T1: 4
---------------	--------------------------------------	--	------------------	---------	-------

350 SLC (107.023) (147 kW | 3.5 Liter)

01.72 → 01.76	M 116.982 / M 116.984		246-082-008-013P	SWP-M-C	T1: 4
---------------	-----------------------	--	------------------	---------	-------

450 SLC 5.0 (107.026) (177 kW | 4.9 Liter)

06.78 → 02.80	M 117.960		246-082-008-013P	SWP-M-C	T1: 4
---------------	-----------	--	------------------	---------	-------

SL (R107)

280 SL (107.042) (130 kW | 2.7 Liter)

06.76 → 09.81	M 110.982 / M 110.986 / M 110.990		246-082-005-002C	SWP-M-C	T1: 4
---------------	--------------------------------------	--	------------------	---------	-------



			VDO		
Datum	Motorcode	Fahrgestell Nr.	Artikel Nr.	Artikelbez.	Information

MERCEDES-BENZ

SL (R107)

280 SL (107.042) (136 kW 2.7 Liter)					
08.74 → 07.85	M 110.982 / M 110.986 / M 110.990		246-082-005-002C	SWP-M-C	T1: 4
08.74 → 08.81	M 110.982 / M 110.986 / M 110.990		246-082-008-013P	SWP-M-C	T1: 4
300 SL (107.041) (132 kW 2.9 Liter)					
09.85 → 08.89	M 103.982		246-082-008-013P	SWP-M-C	T1: 4
350 SL (107.043) (143 kW 3.5 Liter)					
05.71 → 02.80	M 116.982 / M 116.984		246-082-008-013P	SWP-M-C	T1: 4
380 SL (107.045) (150 kW 3.8 Liter)					
09.81 → 08.85	M 116.962		246-082-008-013P	SWP-M-C	T1: 4
380 SL (107.045) (160 kW 3.8 Liter)					
09.80 → 08.81	M 116.960		246-082-008-013P	SWP-M-C	T1: 4
420 SL (107.047) (150 kW 4.1 Liter)					
01.86 → 08.89	M 116.964		246-082-008-013P	SWP-M-C	T1: 4
500 SL (107.046) (164 kW 4.9 Liter)					
01.86 → 08.89	M 117.964		246-082-008-013P	SWP-M-C	T1: 4
500 SL (107.046) (170 kW 4.9 Liter)					
05.80 → 08.85	M 117.960		246-082-008-013P	SWP-M-C	T1: 4

SL (R129)

280 (129.058) (142 kW 2.8 Liter)					
08.93 → 10.01	M 104.943	→ F140421	246-082-008-013P	SWP-M-C	T1: 4
08.93 → 10.01	M 104.943	F140422 →	246-082-008-025G	SWP-M-C	T1: 3
280 (129.059) (150 kW 2.8 Liter)					
05.98 → 10.01	M 112.923 / M 112.925		246-082-008-013P	SWP-M-C	T1: 4
05.98 → 10.01	M 112.923 / M 112.925		246-082-008-025G	SWP-M-C	T1: 3; T13: A210 869 08 21
300 SL (129.060) (140 kW 3.0 Liter)					
03.89 → 07.93	M 103.984	→ F140421	246-082-008-013P	SWP-M-C	T1: 4
07.93 → 08.93	M 103.984	F140422 →	246-082-008-025G	SWP-M-C	T1: 3
300 SL-24 (129.061) (170 kW 3.0 Liter)					
03.89 → 07.93	M 104.981	→ F140421	246-082-008-013P	SWP-M-C	T1: 4
07.93 → 07.93	M 104.981	F140422 →	246-082-008-025G	SWP-M-C	T1: 3
320 (129.064) (165 kW 3.2 Liter)					
05.98 → 10.01	M 112.943		246-082-008-013P	SWP-M-C	T1: 4
05.98 → 10.01	M 112.943		246-082-008-025G	SWP-M-C	T1: 3; T13: A210 869 08 21
320 (129.063) (170 kW 3.2 Liter)					
09.93 → 10.01	M 104.991	→ F140421	246-082-008-013P	SWP-M-C	T1: 4
09.93 → 10.01	M 104.991	F140422 →	246-082-008-025G	SWP-M-C	T1: 3



			VDO		
Datum	Motorcode	Fahrgestell Nr.	Artikel Nr.	Artikelbez.	Information

MERCEDES-BENZ**SL (R129)**

500 (129.068) (225 kW 5.0 Liter)					
05.98 → 10.01	M 113.961		246-082-008-013P	SWP-M-C	T1: 4
05.98 → 10.01	M 113.961		246-082-008-025G	SWP-M-C	T1: 3; T13: A210 869 08 21
500 (129.067) (235 kW 5.0 Liter)					
09.92 → 07.93	M 119.972	→ F140421	246-082-008-013P	SWP-M-C	T1: 4
07.93 → 10.01	M 119.972	F140422 →	246-082-008-025G	SWP-M-C	T1: 3
500 SL (129.066) (240 kW 5.0 Liter)					
09.89 → 08.92	M 119.960 / M 119.972	→ F140421	246-082-008-013P	SWP-M-C	T1: 4
55 AMG (129.068) (260 kW 5.5 Liter)					
03.00 → 10.01	M 113.985		246-082-008-013P	SWP-M-C	T1: 4
03.00 → 10.01	M 113.985		246-082-008-025G	SWP-M-C	T1: 3; T13: A210 869 08 021
60 AMG (129.067) (280 kW 6.0 Liter)					
05.97 → 10.01	M 120.981		246-082-008-013P	SWP-M-C	T1: 4
05.97 → 10.01	M 120.981		246-082-008-025G	SWP-M-C	T1: 3; T13: A210 869 08 21
600 (129.076) (290 kW 6.0 Liter)					
07.92 → 07.93	M 120.981 / M 120.983		246-082-008-013P	SWP-M-C	T1: 4
07.92 → 07.93	M 120.981 / M 120.983		246-082-008-025G	SWP-M-C	T1: 3

SL (R230)

350 (230.467) (180 kW 3.7 Liter)					
03.03 →	M 112.973		246-082-008-025G	SWP-M-C	T1: 3
500 (230.475) (225 kW 5.0 Liter)					
10.01 →	M 113.963		246-075-024-002C	SWP-M-G	T1: 1; T2: C; T13: A000 869 31 21
10.01 →	M 113.963		246-082-008-025G	SWP-M-C	T1: 3
55 AMG (230.474) (350 kW 5.4 Liter)					
10.01 → 06.02	M 113.992		246-075-024-002C	SWP-M-G	T1: 1; T2: C; T13: A000 869 31 21
10.01 → 06.02	M 113.992		246-082-008-025G	SWP-M-C	T1: 3
55 AMG Kompressor (230.474) (368 kW 5.5 Liter)					
06.02 →	M 113.992		246-082-008-025G	SWP-M-C	T1: 3
600 (230.476) (368 kW 5.5 Liter)					
04.03 →	M 275.951		246-082-008-025G	SWP-M-C	T1: 3
65 AMG (230.479) (450 kW 6.0 Liter)					
03.04 →	M 275.981		246-082-008-025G	SWP-M-C	T1: 3

SLK (R170)

200 (170.435) (100 kW 2.0 Liter)					
09.96 → 03.00	M 111.946		246-082-008-025G	SWP-M-C	T1: 3



			VDO		
Datum	Motorcode	Fahrgestell Nr.	Artikel Nr.	Artikelbez.	Information

MERCEDES-BENZ

SLK (R170)

200 Kompressor (170.444) (120 kW | 2.0 Liter)

04.00 → 04.04	M 111.958		246-082-008-025G	SWP-M-C	T1: 3
---------------	-----------	--	------------------	---------	-------

230 Kompressor (170.447) (142 kW | 2.3 Liter)

09.96 → 03.00	M 111.973		246-082-008-025G	SWP-M-C	T1: 3
---------------	-----------	--	------------------	---------	-------

320 (170.465) (160 kW | 3.2 Liter)

03.00 → 04.04	M 112.947		246-082-008-025G	SWP-M-C	T1: 3
---------------	-----------	--	------------------	---------	-------

SLK (R171)

200 Kompressor (171.442) (120 kW | 1.8 Liter)

03.04 →	M 271.944		246-082-008-025G	SWP-M-C	T1: 3
---------	-----------	--	------------------	---------	-------

280 (171.454) (170 kW | 3.0 Liter)

01.05 →	M 272.942		246-082-008-025G	SWP-M-C	T1: 3
---------	-----------	--	------------------	---------	-------

350 (171.456) (200 kW | 3.5 Liter)

06.04 →	M 272.963		246-082-008-025G	SWP-M-C	T1: 3
---------	-----------	--	------------------	---------	-------

55 AMG (171.473) (265 kW | 5.5 Liter)

06.04 →	M 113.989		246-082-008-025G	SWP-M-C	T1: 3
---------	-----------	--	------------------	---------	-------

M-KLASSE (W163)

ML 230 (163.136) (110 kW | 2.3 Liter)

02.98 → 06.05	M 111.977		246-082-008-025G	SWP-M-C	T1: 3
---------------	-----------	--	------------------	---------	-------

ML 320 (163.154) (160 kW | 3.2 Liter)

02.98 → 08.02	M 112.942		246-082-008-025G	SWP-M-C	T1: 3
---------------	-----------	--	------------------	---------	-------

ML 350 (163.157) (180 kW | 3.7 Liter)

08.02 → 06.05	M 112.970		246-082-008-025G	SWP-M-C	T1: 3
---------------	-----------	--	------------------	---------	-------

ML 350 (173 kW | 3.7 Liter)

02.03 → 06.05	M 112.970		246-082-008-025G	SWP-M-C	T1: 3
---------------	-----------	--	------------------	---------	-------

ML 430 (163.172) (200 kW | 4.3 Liter)

03.98 → 06.05	M 113.942		246-082-008-025G	SWP-M-C	T1: 3
---------------	-----------	--	------------------	---------	-------

ML 500 (163.175) (215 kW | 5.0 Liter)

09.01 → 06.05	M 113.964 / M 113.965		246-082-008-025G	SWP-M-C	T1: 3
---------------	-----------------------	--	------------------	---------	-------

ML 55 AMG (163.174) (255 kW | 5.4 Liter)

02.00 → 06.05	M 113.981		246-082-008-025G	SWP-M-C	T1: 3
---------------	-----------	--	------------------	---------	-------





ML 270 CDI (163.113) (120 kW | 2.7 Liter)

12.99 → 06.05	OM 612.963		246-082-008-025G	SWP-M-C	T1: 3
---------------	------------	--	------------------	---------	-------

ML 400 CDI (163.128) (184 kW | 4.0 Liter)

09.01 → 06.05	OM 628.963		246-082-008-025G	SWP-M-C	T1: 3
---------------	------------	--	------------------	---------	-------



			VDO		
Datum	Motorcode	Fahrgestell Nr.	Artikel Nr.	Artikelbez.	Information

MERCEDES-BENZ**G-KLASSE (W460)****230 G (460,2) (66 kW | 2.3 Liter)**

03.79 → 07.93	M 115.973		246-075-021-007C	SWP-M-G	T1: 1; T2: C
03.79 → 07.93	M 115.973		246-075-024-002C	SWP-M-G	T1: 1; T2: C; T8
03.79 → 07.93	M 115.973	900302 →; 024324 →	246-082-008-014C	SWP-M-C	T1: 1

230 G (460,2) (75 kW | 2.3 Liter)

02.80 → 07.87	M 115.973		246-075-021-007C	SWP-M-G	T1: 1; T2: C
02.80 → 07.87	M 115.973		246-075-024-002C	SWP-M-G	T1: 1; T2: C; T8
02.80 → 07.87	M 115.973	024324 →; 900302 →	246-082-008-014C	SWP-M-C	T1: 1

230 GE (460,2) (90 kW | 2.3 Liter)

05.87 → 08.92	M 102.979 / M 102.987		246-075-021-007C	SWP-M-G	T1: 1; T2: C
05.87 → 08.92	M 102.979 / M 102.987		246-075-024-002C	SWP-M-G	T1: 1; T2: C; T8
05.87 → 08.92	M 102.979 / M 102.987	900302 →; 024324 →	246-082-008-014C	SWP-M-C	T1: 1

230 GE (460,2) (92 kW | 2.3 Liter)

04.82 → 08.92	M 102.981 / M 102.987		246-075-021-007C	SWP-M-G	T1: 1; T2: C
04.82 → 08.92	M 102.981 / M 102.987		246-075-024-002C	SWP-M-G	T1: 1; T2: C; T8

280 GE (460,2) (110 kW | 2.7 Liter)

08.84 → 08.89	M 110.994		246-075-021-007C	SWP-M-G	T1: 1; T2: C
08.84 → 08.89	M 110.994		246-075-024-002C	SWP-M-G	T1: 1; T2: C; T8
08.84 → 08.89	M 110.994	900302 →; 024324 →	246-082-008-014C	SWP-M-C	T1: 1

280 GE (460,2) (115 kW | 2.7 Liter)

11.79 → 08.89	M 110.994		246-075-021-007C	SWP-M-G	T1: 1; T2: C
11.79 → 08.89	M 110.994		246-075-024-002C	SWP-M-G	T1: 1; T2: C; T8

240 GD (460,3) (53 kW | 2.4 Liter)

03.79 → 08.87	OM 616.936		246-075-021-007C	SWP-M-G	T1: 1; T2: C
03.79 → 08.87	OM 616.936		246-075-024-002C	SWP-M-G	T1: 1; T2: C; T8
03.79 → 08.87	OM 616.936	900302 →; 024324 →	246-082-008-014C	SWP-M-C	T1: 1





250 GD (460,3) (62 kW | 2.5 Liter)

10.87 → 12.92	OM 602.930		246-075-021-007C	SWP-M-G	T1: 1; T2: C
10.87 → 12.92	OM 602.930		246-075-024-002C	SWP-M-G	T1: 1; T2: C; T8
10.87 → 12.92	OM 602.930	024324 →; 900302 →	246-082-008-014C	SWP-M-C	T1: 1

250 GD (460,3) (68 kW | 2.5 Liter)

12.88 → 08.92	OM 602.930		246-075-021-007C	SWP-M-G	T1: 1; T2: C
12.88 → 08.92	OM 602.930		246-075-024-002C	SWP-M-G	T1: 1; T2: C; T8
12.88 → 08.92	OM 602.930	024324 →; 900302 →	246-082-008-014C	SWP-M-C	T1: 1



			VDO		
Datum	Motorcode	Fahrgestell Nr.	Artikel Nr.	Artikelbez.	Information

MERCEDES-BENZ

G-KLASSE (W460)

300 GD (460,3) (65 kW | 3.0 Liter)

12.79 → 12.91	OM 617.931		246-075-021-007C	SWP-M-G	T1: 1; T2: C
12.79 → 12.91	OM 617.931		246-075-024-002C	SWP-M-G	T1: 1; T2: C; T8
12.79 → 12.91	OM 617.931	024324 →; 900302 →	246-082-008-014C	SWP-M-C	T1: 1

300 GD (460.3) (83 kW | 3.0 Liter)

03.79 → 07.93	OM 603.912		246-075-021-007C	SWP-M-G	T1: 1; T2: C
03.79 → 07.93	OM 603.912		246-075-024-002C	SWP-M-G	T1: 1; T2: C; T8

G-KLASSE (W461)

230 GE (461.238, 461.239) (90 kW | 2.3 Liter)

02.93 →	M 102.979		246-075-024-002C	SWP-M-G	T1: 1; T2: C; T13: A000 869 31 21
02.93 →	M 102.979		246-082-008-025G	SWP-M-C	T1: 3; T13: A210 869 08 21

230 GE (461) (92 kW | 2.3 Liter)

06.93 →	M 102.996 / M 102.997		246-075-024-002C	SWP-M-G	T1: 1; T2: C; T13: A000 869 31 21
06.93 →	M 102.996 / M 102.997		246-082-008-025G	SWP-M-C	T1: 3; T13: A210 869 08 21

250 GD (461) (68 kW | 2.5 Liter)

02.90 →	OM 602.939		246-075-024-002C	SWP-M-G	T1: 1; T2: C; T13: A000 869 31 21
02.90 →	OM 602.939		246-082-008-025G	SWP-M-C	T1: 3; T13: A210 869 08 21

290 GD/G 290 D (461.337, 461.338) (70 kW | 2.9 Liter)

04.92 →	OM 602.942		246-075-024-002C	SWP-M-G	T1: 1; T2: C; T13: A000 869 31 21
04.92 →	OM 602.942		246-082-008-025G	SWP-M-C	T1: 3; T13: A210 869 08 21

G 290 TD (461.335, 461.336) (88 kW | 2.9 Liter)





07.97 →	OM 602.983		246-075-024-002C	SWP-M-G	T1: 1; T2: C; T13: A000 869 31 21
07.97 →	OM 602.983		246-082-008-025G	SWP-M-C	T1: 3; T13: A210 869 08 21

G-KLASSE (W463)

230 GE (463.224, 463.225) (93 kW | 2.3 Liter)

06.90 → 06.93	M 102.989		246-075-024-002C	SWP-M-G	T1: 1; T2: C; T13: A000 869 31 21
06.90 → 06.93	M 102.989		246-082-008-025G	SWP-M-C	T1: 3



			VDO		
Datum	Motorcode	Fahrgestell Nr.	Artikel Nr.	Artikelbez.	Information

MERCEDES-BENZ**G-KLASSE (W463)****300 GE (463.227, 463.228) (125 kW | 3.0 Liter)**

06.90 →	M 103.987		246-075-024-002C	SWP-M-G	T1: 1; T2: C; T13: A000 869 31 21
---------	-----------	--	------------------	---------	--------------------------------------

06.90 →	M 103.987		246-082-008-025G	SWP-M-C	T1: 3
---------	-----------	--	------------------	---------	-------

300 GE (463) (128 kW | 3.0 Liter)

06.90 →	M 103.987		246-082-008-025G	SWP-M-C	T1: 3
---------	-----------	--	------------------	---------	-------

G 320 (463.230, 463.231) (155 kW | 3.2 Liter)

09.94 → 12.97	M 104.996		246-082-008-025G	SWP-M-C	T1: 3
---------------	-----------	--	------------------	---------	-------

G 320 (463.232, 463.233) (158 kW | 3.2 Liter)

07.97 →	M 112.945		246-082-008-025G	SWP-M-C	T1: 3
---------	-----------	--	------------------	---------	-------

G 36 AMG (200 kW | 3.6 Liter)

01.95 →			246-082-008-025G	SWP-M-C	T1: 3
---------	--	--	------------------	---------	-------

G 500 E (463.228) (177 kW | 4.9 Liter)

09.93 →	M 117.965		246-075-024-002C	SWP-M-G	T1: 1; T2: C; T13: A000 869 31 21
---------	-----------	--	------------------	---------	--------------------------------------

09.93 →	M 117.965		246-082-008-025G	SWP-M-C	T1: 3
---------	-----------	--	------------------	---------	-------

G 500 (463.247, 463.248, 463.249) (218 kW | 5.0 Liter)

04.98 →	M 113.962		246-082-008-025G	SWP-M-C	T1: 3
---------	-----------	--	------------------	---------	-------

G 55 AMG (463.243, 463.246) (260 kW | 5.5 Liter)

04.99 →	M 113.982		246-082-008-025G	SWP-M-C	T1: 3
---------	-----------	--	------------------	---------	-------

G 55 AMG (350 kW | 5.4 Liter)

06.04 →	M 113.993		246-082-008-025G	SWP-M-C	T1: 3
---------	-----------	--	------------------	---------	-------

250 GD (463) (69 kW | 2.5 Liter)

06.90 →	OM 602.931		246-082-008-025G	SWP-M-C	T1: 3
---------	------------	--	------------------	---------	-------

G 270 CDI (463.322, 463.323) (115 kW | 2.7 Liter)

10.01 →	OM 612.966		246-075-024-002C	SWP-M-G	T1: 1; T2: C; T13: A000 869 31 21
---------	------------	--	------------------	---------	--------------------------------------

10.01 →	OM 612.966		246-082-008-025G	SWP-M-C	T1: 3
---------	------------	--	------------------	---------	-------

300 GD (463.327, 463.328) (83 kW | 3.0 Liter)

09.89 →	OM 603.931		246-082-008-025G	SWP-M-C	T1: 3
---------	------------	--	------------------	---------	-------

G 300 TD (463.330, 463.331) (130 kW | 3.0 Liter)

08.96 →	OM 606.964		246-082-008-025G	SWP-M-C	T1: 3
---------	------------	--	------------------	---------	-------

350 G Turbo D (463.320, 463.321) (100 kW | 3.4 Liter)

09.91 →	OM 603.972		246-082-008-025G	SWP-M-C	T1: 3
---------	------------	--	------------------	---------	-------

G 400 CDI (463.332, 463.333) (184 kW | 4.0 Liter)

12.00 →	OM 628.962		246-082-008-025G	SWP-M-C	T1: 3
---------	------------	--	------------------	---------	-------

G-KLASSE Geländewagen offen (W463)**230 GE (463.204) (93 kW | 2.3 Liter)**

06.90 → 02.93	M 102.989		246-082-008-025G	SWP-M-C	T1: 3
---------------	-----------	--	------------------	---------	-------

300 GE (463.207) (125 kW | 3.0 Liter)

09.89 → 09.97	M 103.987		246-082-008-025G	SWP-M-C	T1: 3
---------------	-----------	--	------------------	---------	-------

320 GE (463.208) (155 kW | 3.2 Liter)

09.94 → 11.97	M 104.996		246-082-008-025G	SWP-M-C	T1: 3
---------------	-----------	--	------------------	---------	-------



			VDO		
Datum	Motorcode	Fahrgestell Nr.	Artikel Nr.	Artikelbez.	Information

MERCEDES-BENZ

G-KLASSE Geländewagen offen (W463)

G 320 (463.209) (158 kW 3.2 Liter)					
11.97 →	M 112.945		246-082-008-025G	SWP-M-C	T1: 3
G 500 (463) (218 kW 5.0 Liter)					
04.98 →	M 113.962		246-082-008-025G	SWP-M-C	T1: 3
300 GD (463.307) (83 kW 3.0 Liter)					
12.90 → 09.97	OM 603.931		246-082-008-025G	SWP-M-C	T1: 3
G 300 TD (463.308) (130 kW 3.0 Liter)					
09.96 →	OM 606.964		246-082-008-025G	SWP-M-C	T1: 3
350 G Turbo-D (463.300) (100 kW 3.4 Liter)					
09.91 → 09.97	OM 603.972		246-082-008-025G	SWP-M-C	T1: 3
G 400 CDI (463.309) (184 kW 4.0 Liter)					
12.00 →	OM 628.962		246-075-017-002C	SWP-M-G	T1: 4; T2: C
12.00 →	OM 628.962		246-075-021-007C	SWP-M-G	T1: 1; T2: C; T13: A000 869 30 21
12.00 →	OM 628.962		246-075-024-002C	SWP-M-G	T1: 1; T2: C; T13: A000 869 31 21
12.00 →	OM 628.962		246-082-008-025G	SWP-M-C	T1: 3

170 (W170)

V (33 kW 1.7 Liter)					
06.46 → 05.50	M 136.920		246-082-008-025G	SWP-M-C	T1: 3
S (38 kW 1.8 Liter)					
05.49 → 10.56	M 136.922		246-082-008-025G	SWP-M-C	T1: 3
D (29 kW 1.7 Liter)					
06.49 → 10.56	OM 636.915		246-082-008-025G	SWP-M-C	T1: 3
S-D (29 kW 1.8 Liter)					
07.53 → 02.58	OM 636.931		246-082-008-025G	SWP-M-C	T1: 3

HECKFLOSSE (W110)

230 (110.011) (77 kW 2.3 Liter)					
07.65 → 02.68	M 180.945 / M 180.949		246-075-024-002C	SWP-M-G	T1: 1; T2: C; T13: A000 869 31 21

HECKFLOSSE (W111)

220 SEB (111.014) (88 kW 2.2 Liter)					
08.59 → 08.65	M 127.982		246-075-017-002C	SWP-M-G	T1: 4; T2: C

COUPE (W111)

220 SEB (111.021) (88 kW 2.2 Liter)					
01.61 → 12.65	M 127.984		246-075-017-002C	SWP-M-G	T1: 4; T2: C



			VDO		
Datum	Motorcode	Fahrgestell Nr.	Artikel Nr.	Artikelbez.	Information

MERCEDES-BENZ**COUPE (W111)****250 SE (111.021) (110 kW | 2.5 Liter)**

01.65 → 12.67 | M 129.980 / M 129.981 | | 246-075-017-002C | SWP-M-G | T1: 4; T2: C

280 SE (111.024) (118 kW | 2.7 Liter)

01.67 → 12.71 | M 130.980 / M 130.984 | | 246-075-017-002C | SWP-M-G | T1: 4; T2: C

280 SE 3.5 (111.026) (147 kW | 3.5 Liter)

01.69 → 12.71 | M 116.980 | | 246-075-017-002C | SWP-M-G | T1: 4; T2: C

CABRIOLET (W111)**280 SE 3.5 (111.025) (147 kW | 3.5 Liter)**

01.69 → 12.71 | M 116.980 | | 246-075-017-002C | SWP-M-G | T1: 4; T2: C

/8 (W115)**200 (115.015) (63 kW | 2.0 Liter)**

01.68 → 01.77 | M 115.923 / M 115.926 | | 246-069-026-001G | N |

01.76 → 01.77 | M 115.923 / M 115.926 | | 246-082-008-013P | SWP-M-C | T1: 4

200 (70 kW | 2.0 Liter)

01.68 → 01.77 | M 115.923 / M 115.926 | | 246-075-017-002C | SWP-M-G | T1: 4; T2: C

01.68 → 01.77 | M 115.923 / M 115.926 | | 246-075-021-007C | SWP-M-G | T1: 1; T2: C; T13:
A000 869 30 21**220 (115.010) (66 kW | 2.2 Liter)**

01.68 → 07.73 | M 115.924 | | 246-069-026-001G | N |

220 (115.010) (77 kW | 2.2 Liter)

01.68 → 07.73 | M 115.920 | | 246-069-026-001G | N |

200 D (115.115) (40 kW | 2.0 Liter)

01.68 → 01.77 | OM 615.913 | | 246-069-026-001G | N |

01.76 → 01.77 | OM 615.913 | | 246-082-008-013P | SWP-M-C | T1: 4

220 D (115.110) (44 kW | 2.2 Liter)

01.68 → 01.77 | OM 615.912 | | 246-069-026-001G | N |

01.76 → 01.77 | OM 615.912 | | 246-082-008-013P | SWP-M-C | T1: 4

240 D (115.117) (48 kW | 2.4 Liter)

01.76 → 01.77 | OM 616.916 | | 246-082-008-013P | SWP-M-C | T1: 4

/8 (W114)**230.6 (114.015) (88 kW | 2.3 Liter)**

01.68 → 11.76 | M 180.954 | | 246-069-026-001G | N |

250 (96 kW | 2.5 Liter)

07.68 → 08.72 | M 114.920 | | 246-075-017-002C | SWP-M-G | T1: 4; T2: C

07.68 → 08.72 | M 114.920 | | 246-075-021-007C | SWP-M-G | T1: 1; T2: C; T13:
A000 869 30 21



			VDO		
Datum	Motorcode	Fahrgestell Nr.	Artikel Nr.	Artikelbez.	Information

MERCEDES-BENZ

/8 (W114)

250 2.8 (114.023) (96 kW | 2.7 Liter)

06.72 → 11.76	M 130.923		246-075-017-002C	SWP-M-G	T1: 4; T2: C
06.72 → 11.76	M 130.923		246-075-021-007C	SWP-M-G	T1: 1; T2: C; T13: A000 869 30 21

280 E (114.062) (136 kW | 2.7 Liter)

07.74 → 11.76	M 110.981		246-082-008-013P	SWP-M-C	T1: 4
---------------	-----------	--	------------------	---------	-------

/8 Coupe (W114)

250 C (114.021) (96 kW | 2.5 Liter)

04.69 → 06.72	M 114.920		246-075-017-002C	SWP-M-G	T1: 4; T2: C
04.69 → 06.72	M 114.920		246-075-021-007C	SWP-M-G	T1: 1; T2: C; T13: A000 869 30 21

250 CE (114.022) (110 kW | 2.5 Liter)

04.69 → 04.72	M 114.980		246-075-017-002C	SWP-M-G	T1: 4; T2: C
04.69 → 04.72	M 114.980		246-075-021-007C	SWP-M-G	T1: 1; T2: C; T13: A000 869 30 21

250 C 2.8 (114.023) (96 kW | 2.7 Liter)

06.72 → 11.76	M 130.923		246-075-017-002C	SWP-M-G	T1: 4; T2: C
06.72 → 11.76	M 130.923		246-075-021-007C	SWP-M-G	T1: 1; T2: C; T13: A000 869 30 21

280 C (114.073) (118 kW | 2.7 Liter)

06.72 → 02.77	M 110.921		246-075-017-002C	SWP-M-G	T1: 4; T2: C
06.72 → 02.77	M 110.921		246-075-021-007C	SWP-M-G	T1: 1; T2: C; T13: A000 869 30 21

280 CE (114.072) (136 kW | 2.7 Liter)

06.72 → 01.77	M 110.981		246-075-017-002C	SWP-M-G	T1: 4; T2: C
06.72 → 01.77	M 110.981		246-075-021-007C	SWP-M-G	T1: 1; T2: C; T13: A000 869 30 21

PAGODE (W113)

230 SL (113.042) (110 kW | 2.3 Liter)

01.63 → 01.67	M 127.981		246-075-017-002C	SWP-M-G	T1: 4; T2: C
---------------	-----------	--	------------------	---------	--------------

250 SL (113.043) (110 kW | 2.5 Liter)

01.66 → 01.68	M 129.982		246-075-017-002C	SWP-M-G	T1: 4; T2: C
---------------	-----------	--	------------------	---------	--------------

280 SL (113.044) (125 kW | 2.7 Liter)

01.68 → 03.71	M 130.983		246-075-017-002C	SWP-M-G	T1: 4; T2: C
---------------	-----------	--	------------------	---------	--------------

V-KLASSE (638/2)

V 200 (638.214) (95 kW | 2.0 Liter)

02.97 →	M 111.948		246-082-008-014C	SWP-M-C	T1: 1
---------	-----------	--	------------------	---------	-------

V 230 (638.234) (105 kW | 2.3 Liter)

10.96 →	M 111.978		246-082-008-014C	SWP-M-C	T1: 1
---------	-----------	--	------------------	---------	-------



			VDO		
Datum	Motorcode	Fahrgestell Nr.	Artikel Nr.	Artikelbez.	Information

MERCEDES-BENZ

V-KLASSE (638/2)

V 280 (638.244) (128 kW | 2.8 Liter)

08.97 →	M 104.900		246-082-008-014C	SWP-M-C	T1: 1
---------	-----------	--	------------------	---------	-------

V 200 CDI (638.294) (75 kW | 2.2 Liter)

03.99 →	OM 611.980		246-082-008-014C	SWP-M-C	T1: 1
---------	------------	--	------------------	---------	-------

V 220 CDI (638.294) (90 kW | 2.2 Liter)

03.99 →	OM 611.980		246-082-008-014C	SWP-M-C	T1: 1
---------	------------	--	------------------	---------	-------

V 230 TD (638.274) (72 kW | 2.3 Liter)

10.96 →	OM 601.970		246-082-008-014C	SWP-M-C	T1: 1
---------	------------	--	------------------	---------	-------

VIANO (W639)

3.2 (140 kW | 3.2 Liter)

09.03 →	M 112.951		246-082-008-025G	SWP-M-C	T1: 3
---------	-----------	--	------------------	---------	-------

3.2 (160 kW | 3.2 Liter)

09.03 →	M 112.951		246-082-008-025G	SWP-M-C	T1: 3
---------	-----------	--	------------------	---------	-------

3.7 (170 kW | 3.7 Liter)

06.04 →	M 112.976		246-082-008-025G	SWP-M-C	T1: 3
---------	-----------	--	------------------	---------	-------

CDI 2.2 (80 kW | 2.2 Liter)

09.03 →	OM 646.982		246-082-008-025G	SWP-M-C	T1: 3
---------	------------	--	------------------	---------	-------

CDI 2.2 (110 kW | 2.2 Liter)

09.03 →	OM 646.982		246-082-008-025G	SWP-M-C	T1: 3
---------	------------	--	------------------	---------	-------

VITO Bus (638)

113 2.0 (638.114) (95 kW | 2.0 Liter)

02.96 →	M 111.948		246-075-017-002C	SWP-M-G	T1: 4; T2: C
---------	-----------	--	------------------	---------	--------------

02.96 →	M 111.948		246-075-021-007C	SWP-M-G	T1: 1; T2: C; T13: A000 869 30 21
---------	-----------	--	------------------	---------	--------------------------------------

02.96 →	M 111.948		246-075-024-002C	SWP-M-G	T1: 1; T2: C; T13: A000 869 31 21
---------	-----------	--	------------------	---------	--------------------------------------

02.96 →	M 111.948		246-082-008-014C	SWP-M-C	T1: 1
---------	-----------	--	------------------	---------	-------

114 2.3 (638.134) (105 kW | 2.3 Liter)

12.96 →	M 111.978		246-075-017-002C	SWP-M-G	T1: 4; T2: C
---------	-----------	--	------------------	---------	--------------

12.96 →	M 111.978		246-075-021-007C	SWP-M-G	T1: 1; T2: C; T13: A000 869 30 21
---------	-----------	--	------------------	---------	--------------------------------------

12.96 →	M 111.978		246-075-024-002C	SWP-M-G	T1: 1; T2: C; T13: A000 869 31 21
---------	-----------	--	------------------	---------	--------------------------------------

12.96 →	M 111.978		246-082-008-014C	SWP-M-C	T1: 1
---------	-----------	--	------------------	---------	-------

108 CDI 2.2 (60 kW | 2.2 Liter)

03.99 →	OM 611A (60 KW CDI)		246-075-017-002C	SWP-M-G	T1: 4; T2: C
---------	---------------------	--	------------------	---------	--------------

03.99 →	OM 611A (60 KW CDI)		246-075-021-007C	SWP-M-G	T1: 1; T2: C; T13: A000 869 30 21
---------	---------------------	--	------------------	---------	--------------------------------------

03.99 →	OM 611A (60 KW CDI)		246-075-024-002C	SWP-M-G	T1: 1; T2: C; T13: A000 869 31 21
---------	---------------------	--	------------------	---------	--------------------------------------

03.99 →	OM 611A (60 KW CDI)		246-082-008-014C	SWP-M-C	T1: 1
---------	---------------------	--	------------------	---------	-------



			VDO		
Datum	Motorcode	Fahrgestell Nr.	Artikel Nr.	Artikelbez.	Information

MERCEDES-BENZ

VITO Bus (638)

110 CDI 2.2 (75 kW | 2.2 Liter)

03.99 →	OM 611LA (75 KW CDI)		246-075-017-002C	SWP-M-G	T1: 4; T2: C
03.99 →	OM 611LA (75 KW CDI)		246-075-021-007C	SWP-M-G	T1: 1; T2: C; T13: A000 869 30 21
03.99 →	OM 611LA (75 KW CDI)		246-075-024-002C	SWP-M-G	T1: 1; T2: C; T13: A000 869 31 21
03.99 →	OM 611LA (75 KW CDI)		246-082-008-014C	SWP-M-C	T1: 1

112 CDI 2.2 (90 kW | 2.2 Liter)

03.99 →	OM 611.980		246-075-017-002C	SWP-M-G	T1: 4; T2: C
03.99 →	OM 611.980		246-075-021-007C	SWP-M-G	T1: 1; T2: C; T13: A000 869 30 21
03.99 →	OM 611.980		246-075-024-002C	SWP-M-G	T1: 1; T2: C; T13: A000 869 31 21
03.99 →	OM 611.980		246-082-008-014C	SWP-M-C	T1: 1

108 D 2.3 (638.164) (58 kW | 2.3 Liter)

02.96 →	OM 601.942		246-082-008-014C	SWP-M-C	T1: 1
---------	------------	--	------------------	---------	-------

110 TD 2.3 (638.174) (72 kW | 2.3 Liter)

02.96 →	OM 601.970		246-082-008-014C	SWP-M-C	T1: 1
---------	------------	--	------------------	---------	-------

VITO Kasten (638)

113 2.0 (638.014) (95 kW | 2.0 Liter)

03.97 →	M 111.948		246-082-008-014C	SWP-M-C	T1: 1
---------	-----------	--	------------------	---------	-------

114 2.3 (638.034) (105 kW | 2.3 Liter)

03.97 →	M 111.978		246-075-017-002C	SWP-M-G	T1: 4; T2: C
03.97 →	M 111.978		246-075-021-007C	SWP-M-G	T1: 1; T2: C; T13: A000 869 30 21
03.97 →	M 111.978		246-075-024-002C	SWP-M-G	T1: 1; T2: C; T13: A000 869 31 21
03.97 →	M 111.978		246-082-008-014C	SWP-M-C	T1: 1

108 CDI 2.2 (60 kW | 2.2 Liter)

03.99 →	OM 611A (60 KW CDI)		246-075-017-002C	SWP-M-G	T1: 4; T2: C
03.99 →	OM 611A (60 KW CDI)		246-075-021-007C	SWP-M-G	T1: 1; T2: C; T13: A000 869 30 21
03.99 →	OM 611A (60 KW CDI)		246-075-024-002C	SWP-M-G	T1: 1; T2: C; T13: A000 869 31 21
03.99 →	OM 611A (60 KW CDI)		246-082-008-014C	SWP-M-C	T1: 1

110 CDI 2.2 (75 kW | 2.2 Liter)

03.99 →	OM 611LA (75 KW CDI)		246-075-017-002C	SWP-M-G	T1: 4; T2: C
03.99 →	OM 611LA (75 KW CDI)		246-075-021-007C	SWP-M-G	T1: 1; T2: C; T13: A000 869 30 21
03.99 →	OM 611LA (75 KW CDI)		246-075-024-002C	SWP-M-G	T1: 1; T2: C; T13: A000 869 31 21
03.99 →	OM 611LA (75 KW CDI)		246-082-008-014C	SWP-M-C	T1: 1



			VDO		
Datum	Motorcode	Fahrgestell Nr.	Artikel Nr.	Artikelbez.	Information

MERCEDES-BENZ**VITO Kasten (638)****112 CDI 2.2 (90 kW | 2.2 Liter)**

03.99 →	OM 611.980		246-075-017-002C	SWP-M-G	T1: 4; T2: C
03.99 →	OM 611.980		246-075-021-007C	SWP-M-G	T1: 1; T2: C; T13: A000 869 30 21
03.99 →	OM 611.980		246-075-024-002C	SWP-M-G	T1: 1; T2: C; T13: A000 869 31 21
03.99 →	OM 611.980		246-082-008-014C	SWP-M-C	T1: 1

108 D 2.3 (638.064) (58 kW | 2.3 Liter)

03.97 →	OM 601.942		246-082-008-014C	SWP-M-C	T1: 1
---------	------------	--	------------------	---------	-------

110 D 2.3 (638.074) (72 kW | 2.3 Liter)

03.97 →	OM 601.970		246-082-008-014C	SWP-M-C	T1: 1
---------	------------	--	------------------	---------	-------

VITO Bus (W639)**119 (140 kW | 3.0 Liter)**

09.03 →	M 112.951		246-082-008-025G	SWP-M-C	T1: 3
---------	-----------	--	------------------	---------	-------

122 (160 kW | 3.2 Liter)

09.03 →	M 112.951		246-082-008-025G	SWP-M-C	T1: 3
---------	-----------	--	------------------	---------	-------

123 (170 kW | 3.7 Liter)

06.04 →	M 112.976		246-082-008-025G	SWP-M-C	T1: 3
---------	-----------	--	------------------	---------	-------

109 CDI 2.2 (65 kW | 2.2 Liter)

09.03 →			246-075-017-002C	SWP-M-G	T1: 4; T2: C
09.03 →			246-082-008-025G	SWP-M-C	T1: 3

111 CDI 2.2 (80 kW | 2.2 Liter)

09.03 →	OM 646.982		246-075-017-002C	SWP-M-G	T1: 4; T2: C
09.03 →	OM 646.982		246-082-008-025G	SWP-M-C	T1: 3

115 CDI 2.2 (110 kW | 2.2 Liter)

09.03 →	OM 646.982		246-075-017-002C	SWP-M-G	T1: 4; T2: C
09.03 →	OM 646.982		246-075-021-007C	SWP-M-G	T1: 1; T2: C; T13: A000 869 30 21
09.03 →	OM 646.982		246-082-008-025G	SWP-M-C	T1: 3

VITO Kasten (W639)**119 3.2 (140 kW | 3.2 Liter)**

09.03 →	M 112.951		246-082-008-025G	SWP-M-C	T1: 3
---------	-----------	--	------------------	---------	-------

122 3.2 (160 kW | 3.2 Liter)

09.03 →	M 112.951		246-082-008-025G	SWP-M-C	T1: 3
---------	-----------	--	------------------	---------	-------

109 CDI 2.2 (65 kW | 2.2 Liter)

09.03 →			246-075-017-002C	SWP-M-G	T1: 4; T2: C
09.03 →			246-082-008-025G	SWP-M-C	T1: 3

111 CDI 2.2 (80 kW | 2.2 Liter)

09.03 →	OM 646.982		246-075-017-002C	SWP-M-G	T1: 4; T2: C
09.03 →	OM 646.982		246-082-008-025G	SWP-M-C	T1: 3



			VDO		
Datum	Motorcode	Fahrgestell Nr.	Artikel Nr.	Artikelbez.	Information

MERCEDES-BENZ**VITO Kasten (W639)****115 CDI 2.2 (110 kW | 2.2 Liter)**

09.03 →	OM 646.982		246-075-017-002C	SWP-M-G	T1: 4; T2: C
09.03 →	OM 646.982		246-075-021-007C	SWP-M-G	T1: 1; T2: C; T13: A000 869 30 21
09.03 →	OM 646.982		246-082-008-025G	SWP-M-C	T1: 3

T1 Bus (601)**208 2.3 (63 kW | 2.3 Liter)**

05.77 → 12.82	M 115.955 / M 115.972		246-075-021-007C	SWP-M-G	T1: 1; T2: C; T13: A000 869 29 21
05.77 → 12.82	M 115.955 / M 115.972		246-082-008-014C	SWP-M-C	T1: 1

210 2.3 (70 kW | 2.3 Liter)

07.82 → 01.90	M 102.942		246-075-021-007C	SWP-M-G	T1: 1; T2: C; T13: A000 869 29 21
07.82 → 01.90	M 102.942		246-082-008-014C	SWP-M-C	T1: 1

210 2.3 (77 kW | 2.3 Liter)

05.89 → 02.96	M 102.945		246-075-021-007C	SWP-M-G	T1: 1; T2: C; T13: A000 869 29 21
05.89 → 02.96	M 102.945		246-082-008-014C	SWP-M-C	T1: 1

208 D 2.3 (58 kW | 2.3 Liter)

10.88 → 02.96	OM 601.940		246-075-021-007C	SWP-M-G	T1: 1; T2: C; T13: A000 869 29 21
10.88 → 02.96	OM 601.940		246-082-008-014C	SWP-M-C	T1: 1

208 D 2.3 (60 kW | 2.3 Liter)

10.88 → 02.96	OM 601.940		246-075-021-007C	SWP-M-G	T1: 1; T2: C; T13: A000 869 29 21
10.88 → 02.96	OM 601.940		246-082-008-014C	SWP-M-C	T1: 1

207 D 2.4 (48 kW | 2.4 Liter)

05.77 → 12.82	OM 616.917 / OM 616.934	214383 →; 533802 →; → 499999	246-082-008-014C	SWP-M-C	T1: 1
---------------	-------------------------	------------------------------------	------------------	---------	-------

207 D 2.4 (53 kW | 2.4 Liter)

07.82 → 01.90		214383 →; 533802 →; → 499999	246-082-008-014C	SWP-M-C	T1: 1
---------------	--	------------------------------------	------------------	---------	-------

210 D 2.8 (70 kW | 2.8 Liter)

11.88 → 02.96	OM 602.940		246-075-021-007C	SWP-M-G	T1: 1; T2: C; T13: A000 869 29 21
11.88 → 02.96	OM 602.940		246-082-008-014C	SWP-M-C	T1: 1

210 D 2.8 (72 kW | 2.8 Liter)

11.88 → 02.96	OM 602.940		246-075-021-007C	SWP-M-G	T1: 1; T2: C; T13: A000 869 29 21
11.88 → 02.96	OM 602.940		246-082-008-014C	SWP-M-C	T1: 1



			VDO		
Datum	Motorcode	Fahrgestell Nr.	Artikel Nr.	Artikelbez.	Information

MERCEDES-BENZ**T1 Bus (601)****209 D 2.9 (65 kW | 2.9 Liter)**

12.82 → 01.90	OM 617.913		246-075-021-007C	SWP-M-G	T1: 1; T2: C; T13: A000 869 29 21
12.82 → 01.90	OM 617.913		246-082-008-014C	SWP-M-C	T1: 1

T1 Kasten (601)**210 2.3 (70 kW | 2.3 Liter)**

07.82 → 02.96	M 102.942 / M 102.946	533802 →; 214383 →; → 499999	246-082-008-014C	SWP-M-C	T1: 1
---------------	-----------------------	------------------------------------	------------------	---------	-------

210 2.3 (77 kW | 2.3 Liter)

05.89 → 02.96	M 102.945		246-075-021-007C	SWP-M-G	T1: 1; T2: C; T13: A000 869 29 21
05.89 → 02.96	M 102.945		246-082-008-014C	SWP-M-C	T1: 1

208 D 2.3 (58 kW | 2.3 Liter)

11.88 → 02.96	OM 601.940	214383 →; 533802 →; → 499999	246-082-008-014C	SWP-M-C	T1: 1
---------------	------------	------------------------------------	------------------	---------	-------

208 D 2.3 (60 kW | 2.3 Liter)

10.88 → 02.96	OM 601.940		246-075-021-007C	SWP-M-G	T1: 1; T2: C; T13: A000 869 29 21
10.88 → 02.96	OM 601.940		246-082-008-014C	SWP-M-C	T1: 1

207 D 2.4 (53 kW | 2.4 Liter)

06.82 → 01.90	OM 616.937 / OM 616.939	214383 →; 533802 →; → 499999	246-082-008-014C	SWP-M-C	T1: 1
---------------	-------------------------	------------------------------------	------------------	---------	-------

210 D 2.8 (70 kW | 2.8 Liter)

10.88 → 02.96	OM 602.940	214383 →; 533802 →; → 499999	246-082-008-014C	SWP-M-C	T1: 1
---------------	------------	------------------------------------	------------------	---------	-------

210 D 2.8 (72 kW | 2.8 Liter)

10.88 → 02.96	OM 602.940		246-082-008-014C	SWP-M-C	T1: 1
---------------	------------	--	------------------	---------	-------

209 D 2.9 (65 kW | 2.9 Liter)

12.82 → 01.90	OM 617.913	214383 →; 533802 →; → 499999	246-082-008-014C	SWP-M-C	T1: 1
---------------	------------	------------------------------------	------------------	---------	-------

T1 Pritsche/Fahrgestell (601)**210 2.3 (63 kW | 2.3 Liter)**

04.77 → 10.89	M 115.955	214383 →; 533802 →; → 499999	246-082-008-014C	SWP-M-C	T1: 1
---------------	-----------	------------------------------------	------------------	---------	-------



			VDO		
Datum	Motorcode	Fahrgestell Nr.	Artikel Nr.	Artikelbez.	Information

MERCEDES-BENZ

T1 Bus (602)

310 D 2.9 (70 kW 2.9 Liter)					
06.89 → 02.96	OM 602.940		246-075-017-002C	SWP-M-G	T1: 4; T2: C
06.89 → 02.96	OM 602.940		246-075-021-007C	SWP-M-G	T1: 1; T2: C; T13: A000 869 30 21
310 D 2.9 (72 kW 2.9 Liter)					
06.90 → 02.96	OM 602.940		246-075-021-007C	SWP-M-G	T1: 1; T2: C; T13: A000 869 30 21

T1 Kasten (602)

310 D 2.9 (70 kW 2.9 Liter)					
06.89 → 02.96	OM 602.940		246-075-017-002C	SWP-M-G	T1: 4; T2: C
06.89 → 02.96	OM 602.940		246-075-021-007C	SWP-M-G	T1: 1; T2: C; T13: A000 869 30 21
310 D 2.9 (72 kW 2.9 Liter)					
06.89 → 02.96	OM 602.940		246-075-017-002C	SWP-M-G	T1: 4; T2: C
06.89 → 02.96	OM 602.940		246-075-021-007C	SWP-M-G	T1: 1; T2: C; T13: A000 869 30 21
309 D 3.0 (65 kW 3.0 Liter)					
10.82 → 01.90	OM 617.913		246-075-017-002C	SWP-M-G	T1: 4; T2: C
10.82 → 01.90	OM 617.913		246-075-021-007C	SWP-M-G	T1: 1; T2: C; T13: A000 869 30 21
10.82 → 01.90	OM 617.913		246-075-024-002C	SWP-M-G	T1: 1; T2: C; T13: A000 869 31 21

T1 Pritsche/Fahrgestell (602)

310 D 2.9 (70 kW 2.9 Liter)					
06.89 → 02.96	OM 602.940		246-075-017-002C	SWP-M-G	T1: 4; T2: C
06.89 → 02.96	OM 602.940		246-075-021-007C	SWP-M-G	T1: 1; T2: C; T13: A000 869 30 21
310 D 2.9 (72 kW 2.9 Liter)					
06.89 → 02.96	OM 602.940		246-075-017-002C	SWP-M-G	T1: 4; T2: C
06.89 → 02.96	OM 602.940		246-075-021-007C	SWP-M-G	T1: 1; T2: C; T13: A000 869 30 21
309 D 3.0 (65 kW 3.0 Liter)					
10.82 → 01.90	OM 617.913		246-075-017-002C	SWP-M-G	T1: 4; T2: C
10.82 → 01.90	OM 617.913		246-075-021-007C	SWP-M-G	T1: 1; T2: C; T13: A000 869 30 21

SPRINTER 2-t Bus (901, 902)

214 NGT (92 kW 2.3 Liter)					
04.00 →			246-082-008-014C	SWP-M-C	T1: 1



			VDO		
Datum	Motorcode	Fahrgestell Nr.	Artikel Nr.	Artikelbez.	Information

MERCEDES-BENZ

SPRINTER 2-t Bus (901, 902)

214 (105 kW 2.3 Liter)					
02.95 →	M 111.979 / M 111.984		246-082-008-014C	SWP-M-C	T1: 1
208 CDI (60 kW 2.1 Liter)					
04.00 →	OM 611.987		246-082-008-014C	SWP-M-C	T1: 1
211 CDI (80 kW 2.1 Liter)					
04.00 →	OM 611.981		246-082-008-014C	SWP-M-C	T1: 1
213 CDI (95 kW 2.1 Liter)					
04.00 →	OM 611.981		246-082-008-014C	SWP-M-C	T1: 1
208 D (58 kW 2.3 Liter)					
02.95 → 04.00	OM 601.943		246-082-008-014C	SWP-M-C	T1: 1
216 CDI (115 kW 2.7 Liter)					
04.00 →	OM 612.981		246-082-008-014C	SWP-M-C	T1: 1
210 D (75 kW 2.9 Liter)					
03.97 → 04.00	OM 602.980		246-082-008-014C	SWP-M-C	T1: 1
212 D (90 kW 2.9 Liter)					
02.95 → 04.00	OM 602.980		246-082-008-014C	SWP-M-C	T1: 1

SPRINTER 2-t Kasten (901, 902)

214 NGT (92 kW 2.3 Liter)					
04.00 →			246-082-008-014C	SWP-M-C	T1: 1
214 (105 kW 2.3 Liter)					
02.95 →	M 111.979 / M 111.984		246-082-008-014C	SWP-M-C	T1: 1
208 CDI (60 kW 2.1 Liter)					
04.00 →	OM 611.987		246-082-008-014C	SWP-M-C	T1: 1
211 CDI (80 kW 2.1 Liter)					
04.00 →	OM 611.981		246-082-008-014C	SWP-M-C	T1: 1
213 CDI (95 kW 2.1 Liter)					
04.00 →	OM 611.981		246-082-008-014C	SWP-M-C	T1: 1
208 D (58 kW 2.3 Liter)					
02.95 → 04.00	OM 601.943		246-082-008-014C	SWP-M-C	T1: 1
208 D (60 kW 2.3 Liter)					
10.96 → 04.00			246-082-008-014C	SWP-M-C	T1: 1
216 CDI (115 kW 2.7 Liter)					
04.00 →	OM 612.981		246-082-008-014C	SWP-M-C	T1: 1
210 D (75 kW 2.9 Liter)					
01.97 → 04.00	OM 602.980		246-082-008-014C	SWP-M-C	T1: 1
212 D (90 kW 2.9 Liter)					
02.95 → 04.00	OM 602.980		246-082-008-014C	SWP-M-C	T1: 1

SPRINTER 2-t Pritsche/Fahrgestell (901, 902)

214 NGT (92 kW 2.3 Liter)					
04.00 →			246-082-008-014C	SWP-M-C	T1: 1



			VDO		
Datum	Motorcode	Fahrgestell Nr.	Artikel Nr.	Artikelbez.	Information

MERCEDES-BENZ

SPRINTER 2-t Pritsche/Fahrgestell (901, 902)

214 (105 kW 2.3 Liter)					
02.00 →	M 111.979 / M 111.984		246-082-008-014C	SWP-M-C	T1: 1
208 CDI (60 kW 2.1 Liter)					
04.00 →	OM 611.987		246-082-008-014C	SWP-M-C	T1: 1
211 CDI (80 kW 2.1 Liter)					
04.00 →	OM 611.981		246-082-008-014C	SWP-M-C	T1: 1
213 CDI (95 kW 2.1 Liter)					
04.00 →	OM 611.981		246-082-008-014C	SWP-M-C	T1: 1
208 D (58 kW 2.3 Liter)					
01.95 → 04.00	OM 601.943		246-082-008-014C	SWP-M-C	T1: 1
208 D (60 kW 2.3 Liter)					
09.96 → 04.00			246-082-008-014C	SWP-M-C	T1: 1
216 CDI (115 kW 2.7 Liter)					
04.00 →	OM 612.981		246-082-008-014C	SWP-M-C	T1: 1
210 D (75 kW 2.9 Liter)					
01.97 → 04.00	OM 602.980		246-082-008-014C	SWP-M-C	T1: 1
212 D (90 kW 2.9 Liter)					
02.95 → 04.00	OM 602.980		246-082-008-014C	SWP-M-C	T1: 1

SPRINTER 3-t Bus (903)

314 NGT (92 kW 2.3 Liter)					
04.00 →			246-082-008-014C	SWP-M-C	T1: 1
314 (105 kW 2.3 Liter)					
02.95 →	M 111.979 / M 111.984		246-082-008-014C	SWP-M-C	T1: 1
314 4x4 (105 kW 2.3 Liter)					
08.02 →	M 111.979 / M 111.984		246-082-008-014C	SWP-M-C	T1: 1
308 CDI (60 kW 2.1 Liter)					
04.00 →	OM 611.987		246-082-008-014C	SWP-M-C	T1: 1
311 CDI (80 kW 2.1 Liter)					
04.00 →	OM 611.981		246-082-008-014C	SWP-M-C	T1: 1
311 CDI 4x4 (80 kW 2.1 Liter)					
08.02 →	OM 611.981		246-082-008-014C	SWP-M-C	T1: 1
313 CDI (95 kW 2.1 Liter)					
04.00 →			246-082-008-014C	SWP-M-C	T1: 1
313 CDI 4x4 (95 kW 2.1 Liter)					
08.02 →	OM 611.981		246-082-008-014C	SWP-M-C	T1: 1
308 D (58 kW 2.3 Liter)					
02.95 → 04.00	OM 601.943		246-082-008-014C	SWP-M-C	T1: 1
316 CDI (115 kW 2.7 Liter)					
04.00 →	OM 612.981		246-082-008-014C	SWP-M-C	T1: 1
316 CDI 4x4 (115 kW 2.7 Liter)					
08.02 →	OM 612.981		246-082-008-014C	SWP-M-C	T1: 1



			VDO		
Datum	Motorcode	Fahrgestell Nr.	Artikel Nr.	Artikelbez.	Information

MERCEDES-BENZ**SPRINTER 3-t Bus (903)**

310 D 4x4 (75 kW 2.9 Liter)					
05.97 → 08.02	OM 602.980		246-075-017-002C	SWP-M-G	T1: 4; T2: C
05.97 → 08.02	OM 602.980		246-075-021-007C	SWP-M-G	T1: 1; T2: C; T13: A000 869 30 21
05.97 → 08.02	OM 602.980		246-082-008-014C	SWP-M-C	T1: 1
312 D 2.9 (90 kW 2.9 Liter)					
02.95 → 04.00	OM 602.980		246-082-008-014C	SWP-M-C	T1: 1
312 D 2.9 4x4 (90 kW 2.9 Liter)					
05.97 → 08.02	OM 602.980		246-082-008-014C	SWP-M-C	T1: 1
308 E (903.372) (40 kW 0.0 Liter)					
04.00 →			246-082-008-014C	SWP-M-C	T1: 1

SPRINTER 3-t Kasten (903)

314 NGT (92 kW 2.3 Liter)					
04.00 →			246-082-008-014C	SWP-M-C	T1: 1
314 (105 kW 2.3 Liter)					
02.95 →	M 111.979 / M 111.984		246-082-008-014C	SWP-M-C	T1: 1
314 4x4 (105 kW 2.3 Liter)					
08.02 →	M 111.979 / M 111.984		246-082-008-014C	SWP-M-C	T1: 1
308 CDI (60 kW 2.1 Liter)					
04.00 →	OM 611.987		246-082-008-014C	SWP-M-C	T1: 1
311 CDI (80 kW 2.1 Liter)					
04.00 →	OM 611.981		246-082-008-014C	SWP-M-C	T1: 1
311 CDI 4x4 (80 kW 2.1 Liter)					
08.02 →	OM 611.981		246-082-008-014C	SWP-M-C	T1: 1
313 CDI (95 kW 2.1 Liter)					
04.00 →	OM 611.981		246-082-008-014C	SWP-M-C	T1: 1
313 CDI 4x4 (95 kW 2.1 Liter)					
08.02 →	OM 611.981		246-082-008-014C	SWP-M-C	T1: 1
308 D 2.3 (58 kW 2.3 Liter)					
02.95 → 04.00	OM 601.943		246-082-008-014C	SWP-M-C	T1: 1
308 D 2.3 (60 kW 2.3 Liter)					
02.95 → 04.00			246-082-008-014C	SWP-M-C	T1: 1
316 CDI (115 kW 2.7 Liter)					
04.00 →	OM 612.981		246-082-008-014C	SWP-M-C	T1: 1
316 CDI 4x4 (115 kW 2.7 Liter)					
08.02 →	OM 612.981		246-082-008-014C	SWP-M-C	T1: 1
310 D 2.9 (75 kW 2.9 Liter)					
02.95 → 04.00	OM 602.980		246-075-017-002C	SWP-M-G	T1: 4; T2: C
02.95 → 04.00	OM 602.980		246-075-021-007C	SWP-M-G	T1: 1; T2: C; T13: A000 869 30 21
02.95 → 04.00	OM 602.980		246-082-008-014C	SWP-M-C	T1: 1
312 D 2.9 (90 kW 2.9 Liter)					
02.95 → 04.00	OM 602.980		246-082-008-014C	SWP-M-C	T1: 1



			VDO		
Datum	Motorcode	Fahrgestell Nr.	Artikel Nr.	Artikelbez.	Information

MERCEDES-BENZ

SPRINTER 3-t Kasten (903)

312 D 2.9 4x4 (90 kW | 2.9 Liter)

05.97 → 08.02	OM 602.980		246-082-008-014C	SWP-M-C	T1: 1
---------------	------------	--	------------------	---------	-------

SPRINTER 3-t Pritsche/Fahrgestell (903)

314 NGT (92 kW | 2.3 Liter)

04.00 →			246-082-008-014C	SWP-M-C	T1: 1
---------	--	--	------------------	---------	-------

314 (105 kW | 2.3 Liter)

02.00 →	M 111.979 / M 111.984		246-082-008-014C	SWP-M-C	T1: 1
---------	-----------------------	--	------------------	---------	-------

314 4x4 (105 kW | 2.3 Liter)

08.02 →	M 111.979 / M 111.984		246-082-008-014C	SWP-M-C	T1: 1
---------	-----------------------	--	------------------	---------	-------

308 CDI (60 kW | 2.1 Liter)

04.00 →	OM 611.987		246-082-008-014C	SWP-M-C	T1: 1
---------	------------	--	------------------	---------	-------

311 CDI (80 kW | 2.1 Liter)

04.00 →	OM 611.981		246-082-008-014C	SWP-M-C	T1: 1
---------	------------	--	------------------	---------	-------

311 CDI 4x4 (80 kW | 2.1 Liter)

08.02 →	OM 611.981		246-082-008-014C	SWP-M-C	T1: 1
---------	------------	--	------------------	---------	-------

313 CDI (95 kW | 2.1 Liter)

04.00 →	OM 611.981		246-082-008-014C	SWP-M-C	T1: 1
---------	------------	--	------------------	---------	-------

313 CDI 4x4 (95 kW | 2.1 Liter)

08.02 →			246-082-008-014C	SWP-M-C	T1: 1
---------	--	--	------------------	---------	-------

308 D 2.3 (58 kW | 2.3 Liter)

02.95 → 04.00	OM 601.943		246-082-008-014C	SWP-M-C	T1: 1
---------------	------------	--	------------------	---------	-------

308 D 2.3 (60 kW | 2.3 Liter)

11.96 → 04.00			246-082-008-014C	SWP-M-C	T1: 1
---------------	--	--	------------------	---------	-------

316 CDI (115 kW | 2.7 Liter)

04.00 →	OM 612.981		246-082-008-014C	SWP-M-C	T1: 1
---------	------------	--	------------------	---------	-------

316 CDI 4x4 (115 kW | 2.7 Liter)

08.02 →	OM 612.981		246-082-008-014C	SWP-M-C	T1: 1
---------	------------	--	------------------	---------	-------

310 D 2.9 (75 kW | 2.9 Liter)

01.97 → 04.00	OM 602.980		246-075-017-002C	SWP-M-G	T1: 4; T2: C
---------------	------------	--	------------------	---------	--------------

01.97 → 04.00	OM 602.980		246-075-021-007C	SWP-M-G	T1: 1; T2: C; T13: A000 869 30 21
---------------	------------	--	------------------	---------	--------------------------------------

01.97 → 04.00	OM 602.980		246-082-008-014C	SWP-M-C	T1: 1
---------------	------------	--	------------------	---------	-------

312 D 2.9 (90 kW | 2.9 Liter)

02.95 → 04.00	OM 602.980		246-082-008-014C	SWP-M-C	T1: 1
---------------	------------	--	------------------	---------	-------

SPRINTER 4-t Bus (904)

414 (105 kW | 2.3 Liter)

02.96 →	M 111.979 / M 111.984		246-082-008-014C	SWP-M-C	T1: 1
---------	-----------------------	--	------------------	---------	-------

408 CDI (60 kW | 2.1 Liter)

04.00 →	OM 611.987		246-082-008-014C	SWP-M-C	T1: 1
---------	------------	--	------------------	---------	-------

411 CDI (80 kW | 2.1 Liter)

04.00 →	OM 611.981		246-082-008-014C	SWP-M-C	T1: 1
---------	------------	--	------------------	---------	-------



			VDO		
Datum	Motorcode	Fahrgestell Nr.	Artikel Nr.	Artikelbez.	Information

MERCEDES-BENZ

SPRINTER 4-t Bus (904)

413 CDI (95 kW | 2.1 Liter)

04.00 →	OM 611.981		246-082-008-014C	SWP-M-C	T1: 1
---------	------------	--	------------------	---------	-------

416 CDI (115 kW | 2.7 Liter)

04.00 →	OM 612.981		246-082-008-014C	SWP-M-C	T1: 1
---------	------------	--	------------------	---------	-------

SPRINTER 4-t Kasten (904)

414 (105 kW | 2.3 Liter)

02.96 →	M 111.979 / M 111.984		246-082-008-014C	SWP-M-C	T1: 1
---------	-----------------------	--	------------------	---------	-------

414 4x4 (105 kW | 2.3 Liter)

05.97 →	M 111.979 / M 111.984		246-082-008-014C	SWP-M-C	T1: 1
---------	-----------------------	--	------------------	---------	-------

408 CDI (60 kW | 2.1 Liter)

04.00 →	OM 611.987		246-082-008-014C	SWP-M-C	T1: 1
---------	------------	--	------------------	---------	-------

411 CDI (80 kW | 2.1 Liter)

04.00 →	OM 611.981		246-082-008-014C	SWP-M-C	T1: 1
---------	------------	--	------------------	---------	-------

411 CDI 4x4 (80 kW | 2.1 Liter)

04.00 →	OM 611.981		246-082-008-014C	SWP-M-C	T1: 1
---------	------------	--	------------------	---------	-------

413 CDI (95 kW | 2.1 Liter)

04.00 →	OM 611.981		246-082-008-014C	SWP-M-C	T1: 1
---------	------------	--	------------------	---------	-------

413 CDI 4x4 (95 kW | 2.1 Liter)

04.00 →			246-082-008-014C	SWP-M-C	T1: 1
---------	--	--	------------------	---------	-------

408 D (58 kW | 2.3 Liter)

02.96 →	OM 601.943		246-082-008-014C	SWP-M-C	T1: 1
---------	------------	--	------------------	---------	-------

416 CDI (115 kW | 2.7 Liter)

04.00 →	OM 612.981		246-082-008-014C	SWP-M-C	T1: 1
---------	------------	--	------------------	---------	-------

416 CDI 4x4 (115 kW | 2.7 Liter)

04.00 →	OM 612.981		246-082-008-014C	SWP-M-C	T1: 1
---------	------------	--	------------------	---------	-------

410 D (75 kW | 2.9 Liter)

02.96 →	OM 602.980		246-082-008-014C	SWP-M-C	T1: 1
---------	------------	--	------------------	---------	-------

410 D 4x4 (75 kW | 2.9 Liter)

05.97 →	OM 602.980		246-082-008-014C	SWP-M-C	T1: 1
---------	------------	--	------------------	---------	-------

412 D (85 kW | 2.9 Liter)

02.96 →	OM 602.980		246-082-008-014C	SWP-M-C	T1: 1
---------	------------	--	------------------	---------	-------

412 D 4x4 (85 kW | 2.9 Liter)

05.97 →			246-082-008-014C	SWP-M-C	T1: 1
---------	--	--	------------------	---------	-------

412 D (90 kW | 2.9 Liter)

02.96 →	OM 602.980		246-082-008-014C	SWP-M-C	T1: 1
---------	------------	--	------------------	---------	-------

412 D 4x4 (90 kW | 2.9 Liter)

05.97 →	OM 602.980		246-082-008-014C	SWP-M-C	T1: 1
---------	------------	--	------------------	---------	-------

SPRINTER 4-t Pritsche/Fahrgestell (904)

414 (105 kW | 2.3 Liter)

02.00 →	M 111.979 / M 111.984		246-082-008-014C	SWP-M-C	T1: 1
---------	-----------------------	--	------------------	---------	-------



			VDO		
Datum	Motorcode	Fahrgestell Nr.	Artikel Nr.	Artikelbez.	Information

MERCEDES-BENZ

SPRINTER 4-t Pritsche/Fahrgestell (904)

414 4x4 (105 kW 2.3 Liter)					
02.00 →	M 111.979 / M 111.984		246-082-008-014C	SWP-M-C	T1: 1
408 CDI (60 kW 2.1 Liter)					
04.00 →	OM 611.987		246-082-008-014C	SWP-M-C	T1: 1
411 CDI (80 kW 2.1 Liter)					
04.00 →	OM 611.981		246-082-008-014C	SWP-M-C	T1: 1
411 CDI 4x4 (80 kW 2.1 Liter)					
04.00 →	OM 611.981		246-082-008-014C	SWP-M-C	T1: 1
413 CDI (95 kW 2.1 Liter)					
04.00 →	OM 611.981		246-082-008-014C	SWP-M-C	T1: 1
413 CDI 4x4 (95 kW 2.1 Liter)					
04.00 →			246-082-008-014C	SWP-M-C	T1: 1
408 D (58 kW 2.3 Liter)					
02.00 →	OM 601.943		246-082-008-014C	SWP-M-C	T1: 1
416 CDI (115 kW 2.7 Liter)					
04.00 →	OM 612.981		246-082-008-014C	SWP-M-C	T1: 1
416 CDI 4x4 (115 kW 2.7 Liter)					
04.00 →	OM 612.981		246-082-008-014C	SWP-M-C	T1: 1
410 D (75 kW 2.9 Liter)					
02.00 →	OM 602.980		246-082-008-014C	SWP-M-C	T1: 1
410 D 4x4 (75 kW 2.9 Liter)					
02.00 →	OM 602.980		246-082-008-014C	SWP-M-C	T1: 1
412 D (85 kW 2.9 Liter)					
02.00 →	OM 602.980		246-082-008-014C	SWP-M-C	T1: 1
412 D 4x4 (85 kW 2.9 Liter)					
02.00 →			246-082-008-014C	SWP-M-C	T1: 1
412 D (90 kW 2.9 Liter)					
02.00 →	OM 602.980		246-082-008-014C	SWP-M-C	T1: 1
412 D 4x4 (90 kW 2.9 Liter)					
02.00 →	OM 602.980		246-082-008-014C	SWP-M-C	T1: 1

MITSUBISHI

SPACE STAR (DG0)

1.3 16V (60 kW 1.3 Liter)					
09.00 →			246-086-001-002C	HLWP	T1: 3; T3: X11-246-003-013
1.3 16V (61 kW 1.3 Liter)					
11.99 →			246-086-001-002C	HLWP	T1: 3; T3: X11-246-003-013
1.3 16V (63 kW 1.3 Liter)					
11.99 →	4 G 13 (16 V)		246-086-001-002C	HLWP	T1: 3; T3: X11-246-003-013



			VDO		
Datum	Motorcode	Fahrgestell Nr.	Artikel Nr.	Artikelbez.	Information

MITSUBISHI**SPACE STAR (DG0)****1.6 16V (72 kW | 1.6 Liter)**

09.01 →	4G18		246-086-001-002C	HLWP	T1: 3; T3: X11-246-003-013
---------	------	--	------------------	------	-------------------------------

1.8 GDI (82 kW | 1.8 Liter)

10.02 →			246-086-001-002C	HLWP	T1: 3; T3: X11-246-003-013
---------	--	--	------------------	------	-------------------------------

1.8 GDI (87 kW | 1.8 Liter)

11.99 →			246-086-001-002C	HLWP	T1: 3; T3: X11-246-003-013
---------	--	--	------------------	------	-------------------------------

1.8 GDI (90 kW | 1.8 Liter)

11.99 →	4G93		246-086-001-002C	HLWP	T1: 3; T3: X11-246-003-013
---------	------	--	------------------	------	-------------------------------

1.9 DI-D (75 kW | 1.9 Liter)

02.01 →			246-086-001-002C	HLWP	T1: 3; T3: X11-246-003-013
---------	--	--	------------------	------	-------------------------------

1.9 DI-D (85 kW | 1.9 Liter)

10.02 →	F9Q2		246-086-001-002C	HLWP	T1: 3; T3: X11-246-003-013
---------	------	--	------------------	------	-------------------------------

OPEL**AGILA (H00)****1.0 12V (43 kW | 1.0 Liter)**

09.00 →	Z 10 XE		246-083-002-014G	SWP-D-C	T1: 6
---------	---------	--	------------------	---------	-------

1.2 16V (55 kW | 1.2 Liter)

09.00 →	Z 12 XE		246-083-002-014G	SWP-D-C	T1: 6
---------	---------	--	------------------	---------	-------

ASCONA A (81_, 86_, 87_, 88_)**1.2 S (44 kW | 1.2 Liter)**

04.72 → 08.75	12 S		246-082-008-014C	SWP-M-C	T1: 1
---------------	------	--	------------------	---------	-------

1.6 N (44 kW | 1.6 Liter)

03.75 → 08.75	16 N		246-082-008-014C	SWP-M-C	T1: 1
---------------	------	--	------------------	---------	-------

1.6 N (50 kW | 1.6 Liter)

10.70 → 02.75	16 N		246-082-008-014C	SWP-M-C	T1: 1
---------------	------	--	------------------	---------	-------

1.6 S (55 kW | 1.6 Liter)

03.75 → 08.75	16 S		246-082-008-014C	SWP-M-C	T1: 1
---------------	------	--	------------------	---------	-------

1.6 S (59 kW | 1.6 Liter)

10.70 → 02.75	16 S		246-082-008-014C	SWP-M-C	T1: 1
---------------	------	--	------------------	---------	-------

1.9 SR (65 kW | 1.9 Liter)

03.75 → 08.75	19 S		246-082-008-014C	SWP-M-C	T1: 1
---------------	------	--	------------------	---------	-------

1.9 SR (66 kW | 1.9 Liter)

03.71 → 02.75	19 S		246-082-008-014C	SWP-M-C	T1: 1
---------------	------	--	------------------	---------	-------



			VDO		
Datum	Motorcode	Fahrgestell Nr.	Artikel Nr.	Artikelbez.	Information

OPEL**ASCONA B (81_, 86_, 87_, 88_)**

1.3 N (44 kW 1.3 Liter)					
03.79 → 07.81	13 N		246-082-008-014C	SWP-M-C	T1: 1
1.3 S (55 kW 1.3 Liter)					
05.80 → 07.81	13 S		246-082-008-014C	SWP-M-C	T1: 1
1.6 N (44 kW 1.6 Liter)					
07.81 → 08.81	16 N	71000001 →; 72500001 →; 75000001 →	246-082-008-014C	SWP-M-C	T1: 1
2.0 N (66 kW 2.0 Liter)					
08.78 → 07.81	20 N		246-082-008-014C	SWP-M-C	T1: 1
2.0 E (81 kW 2.0 Liter)					
01.80 → 07.81	20 E		246-082-008-014C	SWP-M-C	T1: 1
2.0 D (43 kW 2.0 Liter)					
08.78 → 07.81	20 D		246-082-008-014C	SWP-M-C	T1: 1

ASCONA C CC (84_, 89_)

1.3 S (55 kW 1.3 Liter)					
09.81 → 08.88	13 S		246-082-008-014C	SWP-M-C	T1: 1
1.6 (55 kW 1.6 Liter)					
09.81 → 08.88	16 N		246-082-008-014C	SWP-M-C	T1: 1
1.6 i (55 kW 1.6 Liter)					
09.87 → 08.88	E 16 NZ		246-082-008-014C	SWP-M-C	T1: 1
1.6 S (66 kW 1.6 Liter)					
09.81 → 08.86	16 SH		246-082-008-014C	SWP-M-C	T1: 1
1.8 i (85 kW 1.8 Liter)					
09.82 → 08.86	18 E		246-082-008-014C	SWP-M-C	T1: 1
2.0 i (85 kW 2.0 Liter)					
09.86 → 08.88	20 NE		246-082-008-014C	SWP-M-C	T1: 1
2.0 i KAT (85 kW 2.0 Liter)					
09.86 → 08.88	C 20 NE		246-082-008-014C	SWP-M-C	T1: 1

ASCONA C (81_, 86_, 87_, 88_)

1.3 N (44 kW 1.3 Liter)					
09.81 → 07.83	13 N		246-082-008-014C	SWP-M-C	T1: 1
1.3 S (55 kW 1.3 Liter)					
08.83 → 08.88	13 S		246-082-008-014C	SWP-M-C	T1: 1
1.6 (55 kW 1.6 Liter)					
09.81 → 08.86	16 N		246-082-008-014C	SWP-M-C	T1: 1
1.6 i (55 kW 1.6 Liter)					
09.87 → 08.88	E 16 NZ		246-082-008-014C	SWP-M-C	T1: 1
1.6 i KAT (55 kW 1.6 Liter)					
09.86 → 08.88	C 16 LZ / C 16 NZ		246-082-008-014C	SWP-M-C	T1: 1



			VDO		
Datum	Motorcode	Fahrgestell Nr.	Artikel Nr.	Artikelbez.	Information





OPEL**ASCONA C (81_, 86_, 87_, 88_)**

1.6 (60 kW 1.6 Liter)					
09.86 → 08.88	16 SV		246-082-008-014C	SWP-M-C	T1: 1
1.6 S (66 kW 1.6 Liter)					
09.81 → 08.86	16 SH		246-082-008-014C	SWP-M-C	T1: 1
1.8 (62 kW 1.8 Liter)					
09.87 → 08.88	E 18 NV		246-082-008-014C	SWP-M-C	T1: 1
1.8 E (74 kW 1.8 Liter)					
01.85 → 08.86	C 18 NE / S 18 NV		246-082-008-014C	SWP-M-C	T1: 1
1.8 i (85 kW 1.8 Liter)					
09.82 → 08.86	18 E		246-082-008-014C	SWP-M-C	T1: 1
2.0 i (74 kW 2.0 Liter)					
08.87 → 08.88	C 20 NEF		246-082-008-014C	SWP-M-C	T1: 1
2.0 i (85 kW 2.0 Liter)					
09.86 → 08.88	20 NE		246-082-008-014C	SWP-M-C	T1: 1
2.0 i KAT (85 kW 2.0 Liter)					
09.86 → 08.88	C 20 NE		246-082-008-014C	SWP-M-C	T1: 1
2.0 i GT (95 kW 2.0 Liter)					
03.87 → 08.88	20 SEH		246-082-008-014C	SWP-M-C	T1: 1
1.6 D (40 kW 1.6 Liter)					
03.82 → 08.88	16 D / 16 DA		246-082-008-014C	SWP-M-C	T1: 1

ASTRA F CC (53_, 54_, 58_, 59_)

1.4 i (44 kW 1.4 Liter)					
03.92 → 01.98	C 14 NZ		246-083-001-004C	SWP-D-C	T1: 1; T7: GL →
1.4 (55 kW 1.4 Liter)					
09.91 → 09.93	14 NV		246-083-001-004C	SWP-D-C	T1: 1; T7: GL →
1.4 Si (60 kW 1.4 Liter)					
03.92 → 01.98	C 14 SE		246-083-001-004C	SWP-D-C	T1: 1; T7: GL →
1.4 (60 kW 1.4 Liter)					
09.92 → 01.98	14 SE		246-083-001-004C	SWP-D-C	T1: 1; T7: GL →
1.4 i 16V (66 kW 1.4 Liter)					
01.96 → 01.98	X 14 XE		246-083-001-004C	SWP-D-C	T1: 1; T7: GL →
1.6 i (52 kW 1.6 Liter)					
05.93 → 07.96	X 16 SZ		246-083-001-004C	SWP-D-C	T1: 1; T7: GL →
1.6 i (55 kW 1.6 Liter)					
09.91 → 01.98	C 16 NZ / X 16 SZR		246-083-001-004C	SWP-D-C	T1: 1; T7: GL →
1.6 (55 kW 1.6 Liter)					
09.95 → 01.98	16 LZ2		246-083-001-004C	SWP-D-C	T1: 1; T7: GL →
1.6 Si (74 kW 1.6 Liter)					
03.92 → 12.94	C 16 SE		246-083-001-004C	SWP-D-C	T1: 1; T7: GL →
1.6 i 16V (74 kW 1.6 Liter)					
08.94 → 01.98	X 16 XEL		246-083-001-004C	SWP-D-C	T1: 1; T7: GL →
1.8 i (66 kW 1.8 Liter)					
09.91 → 01.98	C 18 NZ		246-083-001-004C	SWP-D-C	T1: 1; T7: GL →



			VDO		
Datum	Motorcode	Fahrgestell Nr.	Artikel Nr.	Artikelbez.	Information





OPEL**ASTRA F CC (53_, 54_, 58_, 59_)**

1.8 i 16V (85 kW 1.8 Liter)					
09.94 → 01.98	C 18 XEL / X 18 XE		246-083-001-004C	SWP-D-C	T1: 1; T7: GL →
1.8 i 16V (92 kW 1.8 Liter)					
06.93 → 08.94	C 18 XE		246-083-001-004C	SWP-D-C	T1: 1; T7: GL →
2.0 i (85 kW 2.0 Liter)					
09.91 → 01.98	C 20 NE		246-083-001-004C	SWP-D-C	T1: 1; T7: GL →
2.0 i 16V (100 kW 2.0 Liter)					
02.95 → 01.98	X 20 XEV		246-083-001-004C	SWP-D-C	T1: 1; T7: GL →
2.0 GSI 16V (110 kW 2.0 Liter)					
09.91 → 01.98	C 20 XE		246-083-001-004C	SWP-D-C	T1: 1; T7: GL →
1.7 D (42 kW 1.7 Liter)					
12.91 → 09.92	17 D		246-083-001-004C	SWP-D-C	T1: 1; T7: GL →
1.7 D (44 kW 1.7 Liter)					
07.92 → 01.98	17 DR		246-083-001-004C	SWP-D-C	T1: 1; T7: GL →
1.7 TD (50 kW 1.7 Liter)					
11.94 → 01.98	X 17 DTL		246-083-001-004C	SWP-D-C	T1: 1; T7: GL →
1.7 TDS (60 kW 1.7 Liter)					
12.91 → 01.98	17 DT (TC4EE1) / X 17 DT (TC4EE1)		246-083-001-004C	SWP-D-C	T1: 1; T7: GL →

ASTRA F (56_, 57_)

1.4 i (44 kW 1.4 Liter)					
09.91 → 01.98	C 14 NZ		246-082-008-014C	SWP-M-C	T1: 1
09.91 → 09.98	C 14 NZ		246-083-001-004C	SWP-D-C	T1: 1; T7: GL →
1.4 (55 kW 1.4 Liter)					
09.91 → 09.93	14 NV		246-083-001-004C	SWP-D-C	T1: 1; T7: GL →
1.4 Si (60 kW 1.4 Liter)					
03.92 → 03.96	C 14 SE		246-082-008-014C	SWP-M-C	T1: 1
03.92 → 09.98	C 14 SE		246-083-001-004C	SWP-D-C	T1: 1; T7: GL →
1.4 (60 kW 1.4 Liter)					
09.92 → 09.98	14 SE		246-083-001-004C	SWP-D-C	T1: 1; T7: GL →
1.4 i 16V (66 kW 1.4 Liter)					
02.96 → 09.98	X 14 XE		246-083-001-004C	SWP-D-C	T1: 1; T7: GL →
1.6 i (52 kW 1.6 Liter)					
07.95 → 07.96	X 16 SZ		246-082-008-014C	SWP-M-C	T1: 1
05.93 → 07.96	X 16 SZ		246-083-001-004C	SWP-D-C	T1: 1; T7: GL →
1.6 i (55 kW 1.6 Liter)					
03.92 → 08.94	C 16 NZ		246-082-008-014C	SWP-M-C	T1: 1
03.92 → 08.94	C 16 NZ		246-083-001-004C	SWP-D-C	T1: 1; T7: GL →
1.6 i (55 kW 1.6 Liter)					
08.96 → 09.98	X 16 SZR		246-083-001-004C	SWP-D-C	T1: 1; T7: GL →
1.6 (55 kW 1.6 Liter)					
09.95 → 09.98	16 LZ2		246-083-001-004C	SWP-D-C	T1: 1; T7: GL →



			VDO		
Datum	Motorcode	Fahrgestell Nr.	Artikel Nr.	Artikelbez.	Information

OPEL**ASTRA F (56_, 57_)****1.6 Si (74 kW | 1.6 Liter)**

05.92 → 12.94	C 16 SE		246-082-008-014C	SWP-M-C	T1: 1
05.92 → 12.94	C 16 SE		246-083-001-004C	SWP-D-C	T1: 1; T7: GL →

1.6 i 16V (74 kW | 1.6 Liter)

08.94 → 01.98	X 16 XEL		246-082-008-014C	SWP-M-C	T1: 1
08.94 → 09.98	X 16 XEL		246-083-001-004C	SWP-D-C	T1: 1; T7: GL →

1.8 i (66 kW | 1.8 Liter)

03.92 → 01.98	C 18 NZ		246-082-008-014C	SWP-M-C	T1: 1
03.92 → 09.98	C 18 NZ		246-083-001-004C	SWP-D-C	T1: 1; T7: GL →

1.8 i 16V (85 kW | 1.8 Liter)

11.94 → 01.98	C 18 XEL / X 18 XE		246-082-008-014C	SWP-M-C	T1: 1
11.94 → 09.98	C 18 XEL / X 18 XE		246-083-001-004C	SWP-D-C	T1: 1; T7: GL →

1.8 i 16V (92 kW | 1.8 Liter)

07.93 → 10.94	C 18 XE		246-082-008-014C	SWP-M-C	T1: 1
06.93 → 10.94	C 18 XE		246-083-001-004C	SWP-D-C	T1: 1; T7: GL →

2.0 i (85 kW | 2.0 Liter)

03.92 → 01.98	C 20 NE		246-082-008-014C	SWP-M-C	T1: 1
03.92 → 09.98	C 20 NE		246-083-001-004C	SWP-D-C	T1: 1; T7: GL →

2.0 i 16V (100 kW | 2.0 Liter)

02.95 → 01.98	X 20 XEV		246-082-008-014C	SWP-M-C	T1: 1
02.95 → 09.98	X 20 XEV		246-083-001-004C	SWP-D-C	T1: 1; T7: GL →

1.7 D (42 kW | 1.7 Liter)

03.92 → 09.92	17 D		246-082-008-014C	SWP-M-C	T1: 1
03.92 → 09.92	17 D		246-083-001-004C	SWP-D-C	T1: 1; T7: GL →

1.7 D (44 kW | 1.7 Liter)

09.92 → 01.98	17 DR		246-082-008-014C	SWP-M-C	T1: 1
07.92 → 09.98	17 DR		246-083-001-004C	SWP-D-C	T1: 1; T7: GL →

1.7 TD (50 kW | 1.7 Liter)

11.94 → 09.98	X 17 DTL		246-083-001-004C	SWP-D-C	T1: 1; T7: GL →
---------------	----------	--	------------------	---------	-----------------

1.7 TDS (60 kW | 1.7 Liter)

03.92 → 09.98	17 DT (TC4EE1) / X 17 DT (TC4EE1)		246-083-001-004C	SWP-D-C	T1: 1; T7: GL →
---------------	--------------------------------------	--	------------------	---------	-----------------

ASTRA F Caravan (51_, 52_)**1.4 i (44 kW | 1.4 Liter)**

09.91 → 01.98	C 14 NZ		246-083-001-004C	SWP-D-C	T1: 1; T7: GL →
---------------	---------	--	------------------	---------	-----------------

1.4 (55 kW | 1.4 Liter)

09.91 → 09.93	14 NV		246-083-001-004C	SWP-D-C	T1: 1; T7: GL →
---------------	-------	--	------------------	---------	-----------------

1.4 Si (60 kW | 1.4 Liter)

03.92 → 01.98	C 14 SE		246-083-001-004C	SWP-D-C	T1: 1; T7: GL →
---------------	---------	--	------------------	---------	-----------------





1.4 (60 kW | 1.4 Liter)

09.92 → 01.98	14 SE		246-083-001-004C	SWP-D-C	T1: 1; T7: GL →
---------------	-------	--	------------------	---------	-----------------

1.4 i 16V (66 kW | 1.4 Liter)

02.96 → 01.98	X 14 XE		246-083-001-004C	SWP-D-C	T1: 1; T7: GL →
---------------	---------	--	------------------	---------	-----------------



			VDO		
Datum	Motorcode	Fahrgestell Nr.	Artikel Nr.	Artikelbez.	Information





OPEL**ASTRA F Caravan (51_, 52_)**

1.6 i (52 kW 1.6 Liter)					
05.93 → 07.96	X 16 SZ		246-083-001-004C	SWP-D-C	T1: 1; T7: GL →>
1.6 i (55 kW 1.6 Liter)					
09.91 → 01.98	C 16 NZ / X 16 SZR		246-083-001-004C	SWP-D-C	T1: 1; T7: GL →>
1.6 (55 kW 1.6 Liter)					
09.95 → 01.98	16 LZ2		246-083-001-004C	SWP-D-C	T1: 1; T7: GL →>
1.6 Si (74 kW 1.6 Liter)					
03.92 → 12.94	C 16 SE		246-083-001-004C	SWP-D-C	T1: 1; T7: GL →>
1.6 i 16V (74 kW 1.6 Liter)					
08.94 → 01.98	X 16 XEL		246-083-001-004C	SWP-D-C	T1: 1; T7: GL →>
1.8 i (66 kW 1.8 Liter)					
09.91 → 01.98	C 18 NZ		246-083-001-004C	SWP-D-C	T1: 1; T7: GL →>
1.8 i 16V (85 kW 1.8 Liter)					
07.94 → 01.98	C 18 XEL / X 18 XE		246-083-001-004C	SWP-D-C	T1: 1; T7: GL →>
1.8 i 16V (92 kW 1.8 Liter)					
06.93 → 01.98	C 18 XE		246-083-001-004C	SWP-D-C	T1: 1; T7: GL →>
2.0 i (85 kW 2.0 Liter)					
09.91 → 07.94	C 20 NE		246-083-001-004C	SWP-D-C	T1: 1; T7: GL →>
2.0 i 16V (100 kW 2.0 Liter)					
02.95 → 01.98	X 20 XEV		246-083-001-004C	SWP-D-C	T1: 1; T7: GL →>
2.0 i 16V (110 kW 2.0 Liter)					
03.93 → 01.98	C 20 XE		246-083-001-004C	SWP-D-C	T1: 1; T7: GL →>
1.7 D (42 kW 1.7 Liter)					
12.91 → 09.92	17 D		246-083-001-004C	SWP-D-C	T1: 1; T7: GL →>
1.7 D (44 kW 1.7 Liter)					
07.92 → 01.98	17 DR		246-083-001-004C	SWP-D-C	T1: 1; T7: GL →>
1.7 TD (50 kW 1.7 Liter)					
11.94 → 01.98	X 17 DTL		246-083-001-004C	SWP-D-C	T1: 1; T7: GL →>
1.7 TDS (60 kW 1.7 Liter)					
12.91 → 01.98	17 DT (TC4EE1) / X 17 DT (TC4EE1)		246-083-001-004C	SWP-D-C	T1: 1; T7: GL →>

ASTRA F Cabriolet (53_B)

1.4 Si (60 kW 1.4 Liter)					
05.93 → 03.01	C 14 SE		246-083-001-004C	SWP-D-C	T1: 1
1.4 i 16V (66 kW 1.4 Liter)					
01.96 → 03.01	X 14 XE		246-083-001-004C	SWP-D-C	T1: 1
1.6 i (52 kW 1.6 Liter)					
03.93 → 08.96	X 16 SZ		246-083-001-004C	SWP-D-C	T1: 1
1.6 i (55 kW 1.6 Liter)					
01.96 → 03.01	X 16 SZR		246-083-001-004C	SWP-D-C	T1: 1
1.8 i 16V (85 kW 1.8 Liter)					
11.94 → 03.01	C 18 XEL / X 18 XE		246-083-001-004C	SWP-D-C	T1: 1



			VDO		
Datum	Motorcode	Fahrgestell Nr.	Artikel Nr.	Artikelbez.	Information

OPEL**ASTRA F Cabriolet (53_B)****2.0 i (85 kW | 2.0 Liter)**

03.93 → 10.94	C 20 NE		246-083-001-004C	SWP-D-C	T1: 1
---------------	---------	--	------------------	---------	-------

ASTRA F Van (55_)**1.7 TD (50 kW | 1.7 Liter)**

02.98 → 01.99	X 17 DTL		246-083-002-014G	SWP-D-C	T1: 6
---------------	----------	--	------------------	---------	-------

ASTRA F CLASSIC CC**1.6 i (55 kW | 1.6 Liter)**

02.98 →	X 16 SZR		246-083-002-014G	SWP-D-C	T1: 6
---------	----------	--	------------------	---------	-------

1.6 i 16V (74 kW | 1.6 Liter)

02.98 →	X 16 XEL		246-083-002-014G	SWP-D-C	T1: 6
---------	----------	--	------------------	---------	-------

ASTRA F CLASSIC Caravan**1.6 i 16V (74 kW | 1.6 Liter)**

02.98 →	X 16 XEL		246-083-002-014G	SWP-D-C	T1: 6
---------	----------	--	------------------	---------	-------

ASTRA G CC (F48_, F08_)**1.4 16V (66 kW | 1.4 Liter)**

02.98 →	X 14 XE / Z 14 XE		246-083-002-014G	SWP-D-C	T1: 6
---------	-------------------	--	------------------	---------	-------

2.0 16V OPC (118 kW | 2.0 Liter)

11.99 → 12.99	X 20 XER		246-083-002-014G	SWP-D-C	T1: 6
---------------	----------	--	------------------	---------	-------

ASTRA G Stufenheck (F69_)**1.2 16V (48 kW | 1.2 Liter)**

09.98 → 09.00	X 12 XE		246-083-002-014G	SWP-D-C	T1: 6
---------------	---------	--	------------------	---------	-------

2.0 DTI 16V (74 kW | 2.0 Liter)

08.99 →	X 20 DTH / Y 20 DTH		246-083-002-014G	SWP-D-C	T1: 6
---------	---------------------	--	------------------	---------	-------

ASTRA G Caravan (F35_)**1.2 16V (48 kW | 1.2 Liter)**

02.98 → 09.00	X 12 XE		246-083-002-014G	SWP-D-C	T1: 6
---------------	---------	--	------------------	---------	-------

1.4 16V (66 kW | 1.4 Liter)

06.98 →	X 14 XE / Z 14 XE		246-083-002-014G	SWP-D-C	T1: 6
---------	-------------------	--	------------------	---------	-------

1.6 (55 kW | 1.6 Liter)

02.98 → 09.00	X 16 SZR		246-083-002-014G	SWP-D-C	T1: 6
---------------	----------	--	------------------	---------	-------

1.8 16V (85 kW | 1.8 Liter)

02.98 → 09.00	X 18 XE1		246-083-002-014G	SWP-D-C	T1: 6
---------------	----------	--	------------------	---------	-------



			VDO		
Datum	Motorcode	Fahrgestell Nr.	Artikel Nr.	Artikelbez.	Information

OPEL**ASTRA G Caravan (F35_)****2.0 DTI 16V (74 kW | 2.0 Liter)**

08.99 →	X 20 DTH / Y 20 DTH		246-083-002-014G	SWP-D-C	T1: 6
---------	---------------------	--	------------------	---------	-------

ASTRA G Coupe (F07_)**1.8 16V (85 kW | 1.8 Liter)**

03.00 → 10.00	X 18 XE1		246-082-008-021G	SWP-M-C	T1: 6
---------------	----------	--	------------------	---------	-------

ASTRA G Kasten (F70)**1.6 (55 kW | 1.6 Liter)**

01.99 → 09.00	X 16 SZR		246-083-002-014G	SWP-D-C	T1: 6
---------------	----------	--	------------------	---------	-------

CALIBRA A (85_)**2.0 i (85 kW | 2.0 Liter)**

06.90 → 07.97	C 20 NE		246-083-001-004C	SWP-D-C	T1: 1
---------------	---------	--	------------------	---------	-------

2.0 i 4x4 (85 kW | 2.0 Liter)

06.90 → 07.97	C 20 NE		246-083-001-004C	SWP-D-C	T1: 1
---------------	---------	--	------------------	---------	-------

2.0 i 16V (100 kW | 2.0 Liter)

02.94 → 07.97	X 20 XEV		246-083-001-004C	SWP-D-C	T1: 1
---------------	----------	--	------------------	---------	-------

2.0 i 16V 4x4 (100 kW | 2.0 Liter)

02.94 → 07.97	X 20 XEV		246-083-001-004C	SWP-D-C	T1: 1
---------------	----------	--	------------------	---------	-------

2.0 i 16V (110 kW | 2.0 Liter)

06.90 → 02.94	C 20 XE		246-083-001-004C	SWP-D-C	T1: 1
---------------	---------	--	------------------	---------	-------

2.0 i 16V 4x4 (110 kW | 2.0 Liter)

06.90 → 02.94	C 20 XE		246-083-001-004C	SWP-D-C	T1: 1
---------------	---------	--	------------------	---------	-------

2.0 i Turbo 4x4 (150 kW | 2.0 Liter)

03.92 → 07.97	C 20 LET		246-083-001-004C	SWP-D-C	T1: 1
---------------	----------	--	------------------	---------	-------

2.5 i V6 (125 kW | 2.5 Liter)

04.93 → 07.97	C 25 XE / X 25 XE		246-083-001-004C	SWP-D-C	T1: 1
---------------	-------------------	--	------------------	---------	-------

COMMODORE C (14_, 19_)**2.5 S (85 kW | 2.5 Liter)**

08.78 → 07.82	25 S		246-082-008-014C	SWP-M-C	T1: 1
---------------	------	--	------------------	---------	-------

2.5 E (96 kW | 2.5 Liter)

05.81 → 07.82	25 E		246-082-008-014C	SWP-M-C	T1: 1
---------------	------	--	------------------	---------	-------





COMMODORE C Caravan (61)**2.5 S (85 kW | 2.5 Liter)**

05.81 → 07.82	25 S		246-082-008-014C	SWP-M-C	T1: 1
---------------	------	--	------------------	---------	-------

2.5 E (96 kW | 2.5 Liter)

05.81 → 07.82	25 E		246-082-008-014C	SWP-M-C	T1: 1
---------------	------	--	------------------	---------	-------



			VDO		
Datum	Motorcode	Fahrgestell Nr.	Artikel Nr.	Artikelbez.	Information

OPEL**COMBO (71_)****1.2 (33 kW | 1.2 Liter)**

07.94 → 10.01	C 12 NZ / X 12 SZ		246-083-001-004C	SWP-D-C	T1: 1
07.95 → 10.01	C 12 NZ / X 12 SZ		246-083-002-014G	SWP-D-C	T1: 6; T10

1.4 (44 kW | 1.4 Liter)

07.94 → 10.01	C 14 NZ / X 14 SZ		246-083-001-004C	SWP-D-C	T1: 1
---------------	-------------------	--	------------------	---------	-------

1.4 (60 kW | 1.4 Liter)

07.94 → 10.01	C 14 SE		246-083-001-004C	SWP-D-C	T1: 1
---------------	---------	--	------------------	---------	-------

1.4 16V (66 kW | 1.4 Liter)

08.99 → 10.01	X 14 XE		246-083-001-004C	SWP-D-C	T1: 1
---------------	---------	--	------------------	---------	-------

1.7 D (44 kW | 1.7 Liter)

07.94 → 10.01	17 D (4EE1) / X 17 D (4EE1)		246-083-001-004C	SWP-D-C	T1: 1
07.95 → 10.01	17 D (4EE1) / X 17 D (4EE1)		246-083-002-014G	SWP-D-C	T1: 6; T10

CORSA A CC (93_, 94_, 98_, 99_)**1.0 (33 kW | 1.0 Liter)**

05.85 → 12.88	10 S		246-082-008-014C	SWP-M-C	T1: 1
09.82 → 03.93	10 S	- J - 4 000 001 →	246-083-001-004C	SWP-D-C	T1: 1

1.2 (33 kW | 1.2 Liter)

09.82 → 08.90	12 NC / E 12 GV	- J - 4 000 001 →	246-083-001-004C	SWP-D-C	T1: 1
---------------	-----------------	-------------------	------------------	---------	-------

1.2 i (33 kW | 1.2 Liter)

09.89 → 03.93	C 12 NZ	- J - 4 000 001 →	246-083-001-004C	SWP-D-C	T1: 1
---------------	---------	-------------------	------------------	---------	-------

1.2 N (38 kW | 1.2 Liter)

01.90 → 03.93	12 NV	- J - 4 000 001 →	246-083-001-004C	SWP-D-C	T1: 1
---------------	-------	-------------------	------------------	---------	-------

1.2 S (40 kW | 1.2 Liter)

05.85 → 12.88	12 ST		246-082-008-014C	SWP-M-C	T1: 1
09.82 → 02.90	12 ST	- J - 4 000 001 →	246-083-001-004C	SWP-D-C	T1: 1

1.3 (44 kW | 1.3 Liter)

09.85 → 10.89	13 NB	- J - 4 000 001 →	246-083-001-004C	SWP-D-C	T1: 1
---------------	-------	-------------------	------------------	---------	-------

1.3 i (44 kW | 1.3 Liter)

09.86 → 09.90	C 13 N	- J - 4 000 001 →	246-083-001-004C	SWP-D-C	T1: 1
---------------	--------	-------------------	------------------	---------	-------

1.3 S (51 kW | 1.3 Liter)

05.85 → 12.88	13 SB		246-082-008-014C	SWP-M-C	T1: 1
09.82 → 10.89	13 SB	- J - 4 000 001 →	246-083-001-004C	SWP-D-C	T1: 1

1.4 i (40 kW | 1.4 Liter)

01.85 → 03.93		- J - 4 000 001 →	246-083-001-004C	SWP-D-C	T1: 1
---------------	--	-------------------	------------------	---------	-------

1.4 i (44 kW | 1.4 Liter)

01.90 → 03.93	C 14 NZ	- J - 4 000 001 →	246-083-001-004C	SWP-D-C	T1: 1
---------------	---------	-------------------	------------------	---------	-------

1.4 S (53 kW | 1.4 Liter)

01.90 → 03.93	14 NV	- J - 4 000 001 →	246-083-001-004C	SWP-D-C	T1: 1
---------------	-------	-------------------	------------------	---------	-------

1.4 Si (60 kW | 1.4 Liter)

09.91 → 03.93	C 14 SE	- J - 4 000 001 →	246-083-001-004C	SWP-D-C	T1: 1
---------------	---------	-------------------	------------------	---------	-------

1.6 GSI (55 kW | 1.6 Liter)

08.88 → 09.92	C 16 NZ	- J - 4 000 001 →	246-083-001-004C	SWP-D-C	T1: 1
---------------	---------	-------------------	------------------	---------	-------



			VDO		
Datum	Motorcode	Fahrgestell Nr.	Artikel Nr.	Artikelbez.	Information

OPEL**CORSA A CC (93_, 94_, 98_, 99_)****1.6 GSI (72 kW | 1.6 Liter)**

09.89 → 03.93 C 16 SEI - J - 4 000 001 → 246-083-001-004C SWP-D-C T1: 1

1.6 GSI (74 kW | 1.6 Liter)

05.88 → 03.92 E 16 SE - J - 4 000 001 → 246-083-001-004C SWP-D-C T1: 1

1.6 GSI KAT (74 kW | 1.6 Liter)

02.92 → 03.93 C 16 SE - J - 4 000 001 → 246-083-001-004C SWP-D-C T1: 1

1.5 D (37 kW | 1.5 Liter)

09.87 → 03.93 15 D (4EC1) - J - 4 000 001 → 246-083-001-004C SWP-D-C T1: 1

1.5 TD (49 kW | 1.5 Liter)

03.88 → 03.93 15 DT (T4EC1) - J - 4 000 001 → 246-083-001-004C SWP-D-C T1: 1

CORSA A TR (91_, 92_, 96_, 97_)**1.0 (33 kW | 1.0 Liter)**

10.82 → 12.88 10 S 246-082-008-014C SWP-M-C T1: 1

09.82 → 09.92 10 S - J - 4 000 001 → 246-083-001-004C SWP-D-C T1: 1

1.2 N (33 kW | 1.2 Liter)

01.85 → 10.87 12 NC / E 12 GV - J - 4 000 001 → 246-083-001-004C SWP-D-C T1: 1

1.2 i (33 kW | 1.2 Liter)

09.89 → 03.93 C 12 NZ - J - 4 000 001 → 246-083-001-004C SWP-D-C T1: 1

1.2 S (40 kW | 1.2 Liter)

10.82 → 12.88 12 ST 246-082-008-014C SWP-M-C T1: 1

09.82 → 03.93 12 ST - J - 4 000 001 → 246-083-001-004C SWP-D-C T1: 1

1.2 S (43 kW | 1.2 Liter)

09.82 → 10.87 12 S - J - 4 000 001 → 246-083-001-004C SWP-D-C T1: 1

1.3 (44 kW | 1.3 Liter)

09.85 → 10.87 13 NB 246-082-008-014C SWP-M-C T1: 1

09.85 → 10.87 13 NB - J - 4 000 001 → 246-083-001-004C SWP-D-C T1: 1

1.3 S (51 kW | 1.3 Liter)

10.82 → 10.87 13 SB 246-082-008-014C SWP-M-C T1: 1

09.82 → 10.87 13 SB - J - 4 000 001 → 246-083-001-004C SWP-D-C T1: 1

1.4 i (44 kW | 1.4 Liter)

10.89 → 03.93 C 14 NZ - J - 4 000 001 → 246-083-001-004C SWP-D-C T1: 1

1.4 S (53 kW | 1.4 Liter)

09.89 → 03.93 14 NV - J - 4 000 001 → 246-083-001-004C SWP-D-C T1: 1

1.5 D (37 kW | 1.5 Liter)

10.87 → 11.92 15 D (4EC1) - J - 4 000 001 → 246-083-001-004C SWP-D-C T1: 1

1.5 TD (49 kW | 1.5 Liter)

10.87 → 03.93 15 DT (T4EC1) - J - 4 000 001 → 246-083-001-004C SWP-D-C T1: 1

CORSA A Kasten**1.0 (33 kW | 1.0 Liter)**

02.86 → 04.89 10 S - J - 4 000 001 → 246-083-001-004C SWP-D-C T1: 1



			VDO		
Datum	Motorcode	Fahrgestell Nr.	Artikel Nr.	Artikelbez.	Information

OPEL**CORSA A Kasten****1.2 (33 kW | 1.2 Liter)**

02.86 → 04.89 12 NC / E 12 GV - J - 4 000 001 → 246-083-001-004C SWP-D-C T1: 1

1.2 (40 kW | 1.2 Liter)

02.86 → 04.89 12 ST - J - 4 000 001 → 246-083-001-004C SWP-D-C T1: 1

1.3 (44 kW | 1.3 Liter)02.86 → 04.89 13 NB → J2500000;
→ JE1000000;
→ J5000000 246-082-008-014C SWP-M-C T1: 1

02.86 → 04.89 13 NB - J - 4 000 001 → 246-083-001-004C SWP-D-C T1: 1

1.3 (51 kW | 1.3 Liter)

02.86 → 04.89 13 SB - J - 4 000 001 → 246-083-001-004C SWP-D-C T1: 1

1.5 D (37 kW | 1.5 Liter)

06.87 → 04.89 15 D (4EC1) - J - 4 000 001 → 246-083-001-004C SWP-D-C T1: 1

CORSA B (73_, 78_, 79_, F35_)**1.0 i 12V (40 kW | 1.0 Liter)**

11.96 → 09.00 X 10 XE 246-082-008-021G SWP-M-C T1: 6

11.96 → 09.00 X 10 XE 246-083-001-004C SWP-D-C T1: 1

11.96 → 09.00 X 10 XE 246-083-002-014G SWP-D-C T1: 6

1.2 i (33 kW | 1.2 Liter)

03.93 → 09.00 12 NZ 246-083-001-004C SWP-D-C T1: 1

1.2 i (33 kW | 1.2 Liter)

03.93 → 09.00 C 12 NZ / X 12 SZ 246-082-008-021G SWP-M-C T1: 6

03.93 → 09.00 C 12 NZ / X 12 SZ 246-083-001-004C SWP-D-C T1: 1

03.93 → 09.00 C 12 NZ / X 12 SZ 246-083-002-014G SWP-D-C T1: 6

1.2 i 16V (48 kW | 1.2 Liter)

03.98 → 09.00 X 12 XE 246-082-008-021G SWP-M-C T1: 6

03.98 → 09.00 X 12 XE 246-083-001-004C SWP-D-C T1: 1

03.98 → 09.00 X 12 XE 246-083-002-014G SWP-D-C T1: 6

1.4 i (44 kW | 1.4 Liter)

03.93 → 09.00 C 14 NZ / X 14 SZ 246-082-008-021G SWP-M-C T1: 6

03.93 → 09.00 C 14 NZ / X 14 SZ 246-083-001-004C SWP-D-C T1: 1

03.93 → 09.00 C 14 NZ / X 14 SZ 246-083-002-014G SWP-D-C T1: 6

1.4 Si (60 kW | 1.4 Liter)

03.93 → 09.00 C 14 SE 246-082-008-021G SWP-M-C T1: 6

03.93 → 09.00 C 14 SE 246-083-001-004C SWP-D-C T1: 1

03.93 → 09.00 C 14 SE 246-083-002-014G SWP-D-C T1: 6

1.4 i 16V (63 kW | 1.4 Liter)

08.97 → 09.00 C 14 SEL 246-083-001-004C SWP-D-C T1: 1

1.4 i 16V (66 kW | 1.4 Liter)

09.94 → 09.00 X 14 XE 246-082-008-021G SWP-M-C T1: 6

09.94 → 09.00 X 14 XE 246-083-001-004C SWP-D-C T1: 1

09.94 → 09.00 X 14 XE 246-083-002-014G SWP-D-C T1: 6



			VDO		
Datum	Motorcode	Fahrgestell Nr.	Artikel Nr.	Artikelbez.	Information





OPEL**CORSA B (73_, 78_, 79_, F35_)**

1.6 i 16V (74 kW 1.6 Liter)					
08.97 → 09.00	C 16 SEL		246-083-001-004C	SWP-D-C	T1: 1
1.6 i 16V (78 kW 1.6 Liter)					
09.94 → 09.00	X 16 XE		246-082-008-021G	SWP-M-C	T1: 6
09.94 → 09.00	X 16 XE		246-083-001-004C	SWP-D-C	T1: 1
09.94 → 09.00	X 16 XE		246-083-002-014G	SWP-D-C	T1: 6
1.6 GSI 16V (80 kW 1.6 Liter)					
03.93 → 09.00	C 16 XE		246-082-008-021G	SWP-M-C	T1: 6
03.93 → 09.00	C 16 XE		246-083-001-004C	SWP-D-C	T1: 1
03.93 → 09.00	C 16 XE		246-083-002-014G	SWP-D-C	T1: 6
1.5 D (37 kW 1.5 Liter)					
03.93 → 09.00	15 D (4EC1)		246-082-008-021G	SWP-M-C	T1: 6
03.93 → 09.00	15 D (4EC1)		246-083-001-004C	SWP-D-C	T1: 1
03.93 → 09.00	15 D (4EC1)		246-083-002-014G	SWP-D-C	T1: 6
1.5 TD (49 kW 1.5 Liter)					
03.93 → 09.00	15 DT (T4EC1) / X 15 DT (T4EC1)		246-082-008-021G	SWP-M-C	T1: 6
03.93 → 09.00	15 DT (T4EC1) / X 15 DT (T4EC1)		246-083-001-004C	SWP-D-C	T1: 1
03.93 → 09.00	15 DT (T4EC1) / X 15 DT (T4EC1)		246-083-002-014G	SWP-D-C	T1: 6
1.7 D (44 kW 1.7 Liter)					
02.96 → 09.00	17 D (4EE1) / X 17 D (4EE1)		246-082-008-021G	SWP-M-C	T1: 6
02.96 → 09.00	17 D (4EE1) / X 17 D (4EE1)		246-083-001-004C	SWP-D-C	T1: 1
02.96 → 09.00	17 D (4EE1) / X 17 D (4EE1)		246-083-002-014G	SWP-D-C	T1: 6

CORSA C (F08, F68)

1.0 (43 kW 1.0 Liter)					
09.00 →	Z 10 XE		246-082-008-021G	SWP-M-C	T1: 6
09.00 →	Z 10 XE		246-083-002-014G	SWP-D-C	T1: 6
1.2 (55 kW 1.2 Liter)					
09.00 →	Z 12 XE		246-082-008-021G	SWP-M-C	T1: 6
09.00 →	Z 12 XE		246-083-002-014G	SWP-D-C	T1: 6
1.4 (66 kW 1.4 Liter)					
09.00 →	Z 14 XE		246-082-008-021G	SWP-M-C	T1: 6
09.00 →	Z 14 XE		246-083-002-014G	SWP-D-C	T1: 6
1.8 (92 kW 1.8 Liter)					
09.00 →	Z 18 XE		246-082-008-021G	SWP-M-C	T1: 6
09.00 →	Z 18 XE		246-083-002-014G	SWP-D-C	T1: 6
1.7 DI (48 kW 1.7 Liter)					
09.00 →	Y 17 DTL		246-082-008-021G	SWP-M-C	T1: 6
09.00 →	Y 17 DTL		246-083-002-014G	SWP-D-C	T1: 6



			VDO		
Datum	Motorcode	Fahrgestell Nr.	Artikel Nr.	Artikelbez.	Information

OPEL**CORSA C (F08, F68)****1.7 DTI (55 kW | 1.7 Liter)**

09.00 →	Y 17 DT		246-082-008-021G	SWP-M-C	T1: 6
09.00 →	Y 17 DT		246-083-002-014G	SWP-D-C	T1: 6

KADETT C City**1.0 (29 kW | 1.0 Liter)**

08.76 → 07.79	10 N		246-082-008-014C	SWP-M-C	T1: 1
---------------	------	--	------------------	---------	-------

1.2 (38 kW | 1.2 Liter)

08.76 → 04.77	12 N		246-082-008-014C	SWP-M-C	T1: 1
---------------	------	--	------------------	---------	-------

1.2 (40 kW | 1.2 Liter)

07.76 → 07.79	12 N		246-082-008-014C	SWP-M-C	T1: 1
---------------	------	--	------------------	---------	-------

1.2 S (44 kW | 1.2 Liter)

09.75 → 07.79	12 S		246-082-008-014C	SWP-M-C	T1: 1
---------------	------	--	------------------	---------	-------

1.6 S (55 kW | 1.6 Liter)

05.77 → 07.79	16 S		246-082-008-014C	SWP-M-C	T1: 1
---------------	------	--	------------------	---------	-------

KADETT C**1.0 (29 kW | 1.0 Liter)**

07.79 → 07.79	10 N	75000001 →; 72500001 →	246-082-008-014C	SWP-M-C	T1: 1
---------------	------	---------------------------	------------------	---------	-------

01.74 → 07.79	10 N		246-082-008-014C	SWP-M-C	T1: 1
---------------	------	--	------------------	---------	-------

1.2 (38 kW | 1.2 Liter)

07.76 → 04.77	12 N	72500001 →; 75000001 →	246-082-008-014C	SWP-M-C	T1: 1
---------------	------	---------------------------	------------------	---------	-------

1.2 (40 kW | 1.2 Liter)

08.73 → 07.79	12 N		246-082-008-014C	SWP-M-C	T1: 1
---------------	------	--	------------------	---------	-------

1.2 S (44 kW | 1.2 Liter)

08.73 → 07.79	12 S		246-082-008-014C	SWP-M-C	T1: 1
---------------	------	--	------------------	---------	-------

1.6 S (55 kW | 1.6 Liter)

10.77 → 07.79	16 S		246-082-008-014C	SWP-M-C	T1: 1
---------------	------	--	------------------	---------	-------

KADETT C Caravan**1.0 (29 kW | 1.0 Liter)**

07.79 → 07.79	10 N	75000001 →; 72500001 →	246-082-008-014C	SWP-M-C	T1: 1
---------------	------	---------------------------	------------------	---------	-------

1.2 (38 kW | 1.2 Liter)

07.76 → 04.77	12 N	72500001 →; 75000001 →	246-082-008-014C	SWP-M-C	T1: 1
---------------	------	---------------------------	------------------	---------	-------

1.2 (40 kW | 1.2 Liter)

08.73 → 07.79	12 N		246-082-008-014C	SWP-M-C	T1: 1
---------------	------	--	------------------	---------	-------

1.2 S (44 kW | 1.2 Liter)

08.73 → 07.79	12 S		246-082-008-014C	SWP-M-C	T1: 1
---------------	------	--	------------------	---------	-------



			VDO		
Datum	Motorcode	Fahrgestell Nr.	Artikel Nr.	Artikelbez.	Information

OPEL**KADETT C Caravan****1.6 S (55 kW | 1.6 Liter)**

05.77 → 07.79	16 S		246-082-008-014C	SWP-M-C	T1: 1
---------------	------	--	------------------	---------	-------

KADETT C Coupe**1.0 (29 kW | 1.0 Liter)**

09.75 → 07.79	10 N		246-082-008-014C	SWP-M-C	T1: 1
---------------	------	--	------------------	---------	-------

1.2 (38 kW | 1.2 Liter)

08.73 → 07.76	12 N		246-082-008-014C	SWP-M-C	T1: 1
---------------	------	--	------------------	---------	-------

1.2 (40 kW | 1.2 Liter)

08.73 → 07.79	12 N		246-082-008-014C	SWP-M-C	T1: 1
---------------	------	--	------------------	---------	-------

1.2 S (44 kW | 1.2 Liter)

08.73 → 07.79	12 S		246-082-008-014C	SWP-M-C	T1: 1
---------------	------	--	------------------	---------	-------

1.6 S (55 kW | 1.6 Liter)

05.77 → 07.79	16 S		246-082-008-014C	SWP-M-C	T1: 1
---------------	------	--	------------------	---------	-------

1.9 GT/E (77 kW | 1.9 Liter)

09.75 → 07.77	19 E		246-082-008-014C	SWP-M-C	T1: 1
---------------	------	--	------------------	---------	-------

2.0 E Rallye (81 kW | 2.0 Liter)

08.77 → 07.79	20 E		246-082-008-014C	SWP-M-C	T1: 1
---------------	------	--	------------------	---------	-------

2.0 GT/E (85 kW | 2.0 Liter)

08.77 → 07.79	20 EH		246-082-008-014C	SWP-M-C	T1: 1
---------------	-------	--	------------------	---------	-------

KADETT D (31_-34_, 41_-44_)**1.2 (39 kW | 1.2 Liter)**

08.79 → 07.82	12 N		246-082-008-014C	SWP-M-C	T1: 1
---------------	------	--	------------------	---------	-------

1.2 (40 kW | 1.2 Liter)

08.82 → 08.84	12 ST		246-082-008-014C	SWP-M-C	T1: 1
---------------	-------	--	------------------	---------	-------

1.2 S (44 kW | 1.2 Liter)

08.79 → 07.84	12 S		246-082-008-014C	SWP-M-C	T1: 1
---------------	------	--	------------------	---------	-------

1.3 N (44 kW | 1.3 Liter)

08.79 → 08.84	13 N		246-082-008-014C	SWP-M-C	T1: 1
---------------	------	--	------------------	---------	-------

1.3 S (55 kW | 1.3 Liter)

10.79 → 07.84	13 S		246-082-008-014C	SWP-M-C	T1: 1
---------------	------	--	------------------	---------	-------

1.6 S (66 kW | 1.6 Liter)

09.81 → 08.84	16 SH		246-082-008-014C	SWP-M-C	T1: 1
---------------	-------	--	------------------	---------	-------

1.8 GT/E (85 kW | 1.8 Liter)

05.83 → 08.84	18 E		246-082-008-014C	SWP-M-C	T1: 1
---------------	------	--	------------------	---------	-------

1.6 D (40 kW | 1.6 Liter)

04.82 → 08.84	16 D		246-082-008-014C	SWP-M-C	T1: 1
---------------	------	--	------------------	---------	-------

KADETT D Caravan (35_, 36_, 45_, 46_)**1.2 (39 kW | 1.2 Liter)**

08.79 → 07.82	12 N		246-082-008-014C	SWP-M-C	T1: 1
---------------	------	--	------------------	---------	-------



			VDO		
Datum	Motorcode	Fahrgestell Nr.	Artikel Nr.	Artikelbez.	Information

OPEL**KADETT D Caravan (35_, 36_, 45_, 46_)****1.2 S (44 kW | 1.2 Liter)**

08.79 → 07.84 12 S 246-082-008-014C SWP-M-C T1: 1

1.3 N (44 kW | 1.3 Liter)

08.79 → 08.84 13 N 246-082-008-014C SWP-M-C T1: 1

1.3 S (55 kW | 1.3 Liter)

08.79 → 08.84 13 S 246-082-008-014C SWP-M-C T1: 1

1.6 S (66 kW | 1.6 Liter)

09.81 → 08.84 16 SH 246-082-008-014C SWP-M-C T1: 1

1.6 D (40 kW | 1.6 Liter)

04.82 → 08.84 16 D 246-082-008-014C SWP-M-C T1: 1

KADETT E CC (33_, 34_, 43_, 44_)**1.2 (40 kW | 1.2 Liter)**09.84 → 07.86 12 SC J 2 500 001 →;
J 5 000 001 →;
J E 100 001 → 246-083-001-004C SWP-D-C T1: 1**1.3 N (44 kW | 1.3 Liter)**09.84 → 08.91 13 N / 13 NB J 2 500 001 →;
J 5 000 001 →;
J E 100 001 → 246-083-001-004C SWP-D-C T1: 1**1.3 i KAT (44 kW | 1.3 Liter)**09.85 → 08.91 C 13 N J 2 500 001 →;
J 5 000 001 →;
J E 100 001 → 246-083-001-004C SWP-D-C T1: 1**1.3 S (55 kW | 1.3 Liter)**09.84 → 12.86 13 S → JE100000;
→ J5000000;
→ J2500000 246-082-008-014C SWP-M-C T1: 109.84 → 08.87 13 S J 2 500 001 →;
J 5 000 001 →;
J E 100 001 → 246-083-001-004C SWP-D-C T1: 1**1.4 i (44 kW | 1.4 Liter)**01.90 → 08.91 C 14 NZ J 2 500 001 →;
J 5 000 001 →;
J E 100 001 → 246-083-001-004C SWP-D-C T1: 1**1.4 S (55 kW | 1.4 Liter)**01.90 → 08.91 14 NV J 2 500 001 →;
J 5 000 001 →;
J E 100 001 → 246-083-001-004C SWP-D-C T1: 1**1.6 i (55 kW | 1.6 Liter)**09.86 → 08.91 E 16 NZ → J2500000;
→ J5000000;
→ JE100000 246-082-008-014C SWP-M-C T1: 1



			VDO		
Datum	Motorcode	Fahrgestell Nr.	Artikel Nr.	Artikelbez.	Information

OPEL**KADETT E CC (33_, 34_, 43_, 44_)****1.6 i (55 kW | 1.6 Liter)**

09.86 → 08.91	E 16 NZ	J 2 500 001 →; J 5 000 001 →; J E 100 001 →	246-083-001-004C	SWP-D-C	T1: 1
---------------	---------	---------------------------------------------------	------------------	---------	-------

1.6 i KAT (55 kW | 1.6 Liter)

09.86 → 08.91	C 16 LZ / C 16 NZ	J 2 500 001 →; J 5 000 001 →; J E 100 001 →	246-083-001-004C	SWP-D-C	T1: 1
---------------	-------------------	---------------------------------------------------	------------------	---------	-------

1.6 S (60 kW | 1.6 Liter)

09.86 → 08.91	16 SV	→ JE100000; → J2500000; → J5000000	246-082-008-014C	SWP-M-C	T1: 1
---------------	-------	------------------------------------------	------------------	---------	-------

09.86 → 08.91	16 SV	J 2 500 001 →; J 5 000 001 →; J E 100 001 →	246-083-001-004C	SWP-D-C	T1: 1
---------------	-------	---------------------------------------------------	------------------	---------	-------

1.6 S (66 kW | 1.6 Liter)

09.84 → 08.86	16 SH		246-082-008-014C	SWP-M-C	T1: 1
---------------	-------	--	------------------	---------	-------

09.84 → 08.86	16 SH	J 2 500 001 →; J 5 000 001 →; J E 100 001 →	246-083-001-004C	SWP-D-C	T1: 1
---------------	-------	---------------------------------------------------	------------------	---------	-------

1.8 S (62 kW | 1.8 Liter)

09.87 → 08.91	E 18 NV / S 18 NV	J 2 500 001 →; J 5 000 001 →; J E 100 001 →	246-083-001-004C	SWP-D-C	T1: 1
---------------	-------------------	---------------------------------------------------	------------------	---------	-------

1.8 i (66 kW | 1.8 Liter)

06.85 → 08.91	C 18 NT / C 18 NZ / S 18 NV	J 2 500 001 →; J 5 000 001 →; J E 100 001 →	246-083-001-004C	SWP-D-C	T1: 1
---------------	-----------------------------	---------------------------------------------------	------------------	---------	-------

1.8 E (74 kW | 1.8 Liter)

10.85 → 08.86	C 18 NE		246-082-008-014C	SWP-M-C	T1: 1
---------------	---------	--	------------------	---------	-------

10.85 → 08.86	C 18 NE	J 2 500 001 →; J 5 000 001 →; J E 100 001 →	246-083-001-004C	SWP-D-C	T1: 1
---------------	---------	---------------------------------------------------	------------------	---------	-------

1.8 GSI (85 kW | 1.8 Liter)

09.84 → 08.86	18 E	J 2 500 001 →; J 5 000 001 →; J E 100 001 →	246-083-001-004C	SWP-D-C	T1: 1
---------------	------	---------------------------------------------------	------------------	---------	-------

2.0 GSI (85 kW | 2.0 Liter)

09.86 → 08.91	20 NE	→ JE100000; → J2500000; → J5000000	246-082-008-014C	SWP-M-C	T1: 1
---------------	-------	------------------------------------------	------------------	---------	-------

09.86 → 08.91	20 NE	J 2 500 001 →; J 5 000 001 →; J E 100 001 →	246-083-001-004C	SWP-D-C	T1: 1
---------------	-------	---------------------------------------------------	------------------	---------	-------



			VDO		
Datum	Motorcode	Fahrgestell Nr.	Artikel Nr.	Artikelbez.	Information

OPEL**KADETT E CC (33_, 34_, 43_, 44_)****2.0 GSI KAT (85 kW | 2.0 Liter)**

09.86 → 08.91	C 20 NE	J 2 500 001 →; J 5 000 001 →; J E 100 001 →	246-083-001-004C	SWP-D-C	T1: 1
---------------	---------	---------------------------------------------------	------------------	---------	-------

2.0 GSI (95 kW | 2.0 Liter)

09.86 → 08.91	20 SEH	→ J2500000; → JE100000; → J5000000	246-082-008-014C	SWP-M-C	T1: 1
---------------	--------	------------------------------------------	------------------	---------	-------

09.86 → 08.91	20 SEH	J 2 500 001 →; J 5 000 001 →; J E 100 001 →	246-083-001-004C	SWP-D-C	T1: 1
---------------	--------	---------------------------------------------------	------------------	---------	-------

2.0 GSI 16V (110 kW | 2.0 Liter)

03.88 → 08.91	20 XEJ	J 2 500 001 →; J 5 000 001 →; J E 100 001 →	246-083-001-004C	SWP-D-C	T1: 1
---------------	--------	---------------------------------------------------	------------------	---------	-------

2.0 GSI 16V KAT (110 kW | 2.0 Liter)

03.88 → 08.91	C 20 XE	J 2 500 001 →; J 5 000 001 →; J E 100 001 →	246-083-001-004C	SWP-D-C	T1: 1
---------------	---------	---------------------------------------------------	------------------	---------	-------

2.0 GSI 16V (115 kW | 2.0 Liter)

12.87 → 08.91	20 XE	J 2 500 001 →; J 5 000 001 →; J E 100 001 →	246-083-001-004C	SWP-D-C	T1: 1
---------------	-------	---------------------------------------------------	------------------	---------	-------

1.5 TD (53 kW | 1.5 Liter)

07.88 → 08.91	15 DT (T4EC1)	J 2 500 001 →; J 5 000 001 →; J E 100 001 →	246-083-001-004C	SWP-D-C	T1: 1
---------------	---------------	---------------------------------------------------	------------------	---------	-------

1.6 D (40 kW | 1.6 Liter)

09.84 → 12.86	16 D / 16 DA	→ J5000000; → J2500000; → JE100000	246-082-008-014C	SWP-M-C	T1: 1
---------------	--------------	------------------------------------------	------------------	---------	-------

09.84 → 01.89	16 D / 16 DA	J 2 500 001 →; J 5 000 001 →; J E 100 001 →	246-083-001-004C	SWP-D-C	T1: 1
---------------	--------------	---------------------------------------------------	------------------	---------	-------

1.7 D (42 kW | 1.7 Liter)

02.89 → 08.91	17 D	J 2 500 001 →; J 5 000 001 →; J E 100 001 →	246-083-001-004C	SWP-D-C	T1: 1
---------------	------	---------------------------------------------------	------------------	---------	-------



			VDO		
Datum	Motorcode	Fahrgestell Nr.	Artikel Nr.	Artikelbez.	Information

OPEL

KADETT E (39_, 49_)

1.2 (40 kW | 1.2 Liter)

08.85 → 07.86	12 SC		246-082-008-014C	SWP-M-C	T1: 1
09.84 → 07.86	12 SC	J 2 500 001 →; J 5 000 001 →; J E 100 001 →	246-083-001-004C	SWP-D-C	T1: 1

1.3 N (44 kW | 1.3 Liter)

08.85 → 12.86	13 N / 13 NB	→ J5000000; → J25000000; → JE100000	246-082-008-014C	SWP-M-C	T1: 1
09.84 → 08.89	13 N / 13 NB	J 2 500 001 →; J 5 000 001 →; J E 100 001 →	246-083-001-004C	SWP-D-C	T1: 1

1.3 i KAT (44 kW | 1.3 Liter)

09.85 → 08.91	C 13 N	J 2 500 001 →; J 5 000 001 →; J E 100 001 →	246-083-001-004C	SWP-D-C	T1: 1
---------------	--------	---------------------------------------------------	------------------	---------	-------

1.3 S (55 kW | 1.3 Liter)

09.86 → 08.87	13 S	→ JE100000; → J5000000; → J2500000	246-082-008-014C	SWP-M-C	T1: 1
09.84 → 08.87	13 S	J 2 500 001 →; J 5 000 001 →; J E 100 001 →	246-083-001-004C	SWP-D-C	T1: 1

1.4 i (44 kW | 1.4 Liter)

01.90 → 08.91	C 14 NZ	J 2 500 001 →; J 5 000 001 →; J E 100 001 →	246-083-001-004C	SWP-D-C	T1: 1
---------------	---------	---------------------------------------------------	------------------	---------	-------

1.4 S (55 kW | 1.4 Liter)

01.90 → 08.91	14 NV	J 2 500 001 →; J 5 000 001 →; J E 100 001 →	246-083-001-004C	SWP-D-C	T1: 1
---------------	-------	---------------------------------------------------	------------------	---------	-------





1.6 i (55 kW | 1.6 Liter)

09.86 → 08.91	E 16 NZ	→ J5000000; → JE100000; → J2500000	246-082-008-014C	SWP-M-C	T1: 1
09.86 → 08.91	E 16 NZ	J 2 500 001 →; J 5 000 001 →; J E 100 001 →	246-083-001-004C	SWP-D-C	T1: 1

1.6 i KAT (55 kW | 1.6 Liter)

09.86 → 08.91	C 16 LZ / C 16 NZ	J 2 500 001 →; J 5 000 001 →; J E 100 001 →	246-083-001-004C	SWP-D-C	T1: 1
---------------	-------------------	---------------------------------------------------	------------------	---------	-------



			VDO		
Datum	Motorcode	Fahrgestell Nr.	Artikel Nr.	Artikelbez.	Information

OPEL**KADETT E (39_, 49_)****1.6 S (60 kW | 1.6 Liter)**

09.86 → 08.91	16 SV	→ J2500000; → JE100001; → J5000000	246-082-008-014C	SWP-M-C	T1: 1
09.86 → 08.91	16 SV	J 2 500 001 →; J 5 000 001 →; J E 100 001 →	246-083-001-004C	SWP-D-C	T1: 1

1.6 S (66 kW | 1.6 Liter)

09.84 → 08.86	16 SH		246-082-008-014C	SWP-M-C	T1: 1
09.84 → 08.86	16 SH	J 2 500 001 →; J 5 000 001 →; J E 100 001 →	246-083-001-004C	SWP-D-C	T1: 1

1.8 S (62 kW | 1.8 Liter)

09.87 → 08.91	E 18 NV	→ J2500000; → JE100000; → J5000000	246-082-008-014C	SWP-M-C	T1: 1
09.87 → 08.91	E 18 NV	J 2 500 001 →; J 5 000 001 →; J E 100 001 →	246-083-001-004C	SWP-D-C	T1: 1

1.8 i (66 kW | 1.8 Liter)

09.90 → 08.91	C 18 NT / C 18 NZ	→ J5000000; → J2500000; → JE100000	246-082-008-014C	SWP-M-C	T1: 1
09.90 → 08.91	C 18 NT / C 18 NZ	J 2 500 001 →; J 5 000 001 →; J E 100 001 →	246-083-001-004C	SWP-D-C	T1: 1

1.8 i (74 kW | 1.8 Liter)

10.85 → 08.86	C 18 NE	J 2 500 001 →; J 5 000 001 →; J E 100 001 →	246-083-001-004C	SWP-D-C	T1: 1
---------------	---------	---------------------------------------------------	------------------	---------	-------

1.8 (84 kW | 1.8 Liter)

09.87 → 08.90	18 E	J 2 500 001 →; J 5 000 001 →; J E 100 001 →	246-083-001-004C	SWP-D-C	T1: 1
---------------	------	---------------------------------------------------	------------------	---------	-------

1.8 i (85 kW | 1.8 Liter)

09.84 → 08.86	18 E	J 2 500 001 →; J 5 000 001 →; J E 100 001 →	246-083-001-004C	SWP-D-C	T1: 1
---------------	------	---------------------------------------------------	------------------	---------	-------

2.0 i (85 kW | 2.0 Liter)

03.87 → 08.91	20 NE	→ J5000000; → J2500000; → JE100000	246-082-008-014C	SWP-M-C	T1: 1
03.87 → 08.91	20 NE	J 2 500 001 →; J 5 000 001 →; J E 100 001 →	246-083-001-004C	SWP-D-C	T1: 1



			VDO		
Datum	Motorcode	Fahrgestell Nr.	Artikel Nr.	Artikelbez.	Information

OPEL**KADETT E (39_, 49_)****2.0 i KAT (85 kW | 2.0 Liter)**

03.87 → 08.91	C 20 NE	J 2 500 001 →; J 5 000 001 →; J E 100 001 →	246-083-001-004C	SWP-D-C	T1: 1
---------------	---------	---------------------------------------------------	------------------	---------	-------

1.5 TD (53 kW | 1.5 Liter)

07.88 → 08.91	15 DT (T4EC1)	J 2 500 001 →; J 5 000 001 →; J E 100 001 →	246-083-001-004C	SWP-D-C	T1: 1
---------------	---------------	---------------------------------------------------	------------------	---------	-------

1.6 D (40 kW | 1.6 Liter)

08.85 → 12.86	16 D / 16 DA	→ J2500000; → JE1000000; → J5000000	246-082-008-014C	SWP-M-C	T1: 1
---------------	--------------	-------------------------------------------	------------------	---------	-------

09.84 → 01.89	16 D / 16 DA	J 2 500 001 →; J 5 000 001 →; J E 100 001 →	246-083-001-004C	SWP-D-C	T1: 1
---------------	--------------	---------------------------------------------------	------------------	---------	-------

1.7 D (42 kW | 1.7 Liter)

02.89 → 08.91	17 D	J 2 500 001 →; J 5 000 001 →; J E 100 001 →	246-083-001-004C	SWP-D-C	T1: 1
---------------	------	---------------------------------------------------	------------------	---------	-------

KADETT E Caravan (35_, 36_, 45_, 46_)**1.6 S (66 kW | 1.6 Liter)**

09.84 → 08.86	16 SH		246-082-008-014C	SWP-M-C	T1: 1
---------------	-------	--	------------------	---------	-------

KADETT E Cabriolet (43B_)**1.3 S (55 kW | 1.3 Liter)**

03.87 → 02.93	13 S		246-083-001-004C	SWP-D-C	T1: 1
---------------	------	--	------------------	---------	-------

1.4 i (44 kW | 1.4 Liter)

01.90 → 08.91	C 14 NZ		246-083-001-004C	SWP-D-C	T1: 1
---------------	---------	--	------------------	---------	-------

1.4 S (55 kW | 1.4 Liter)

08.90 → 02.93	14 NV		246-083-001-004C	SWP-D-C	T1: 1
---------------	-------	--	------------------	---------	-------

1.6 i (55 kW | 1.6 Liter)

10.86 → 02.93	E 16 NZ		246-083-001-004C	SWP-D-C	T1: 1
---------------	---------	--	------------------	---------	-------

1.6 i KAT (55 kW | 1.6 Liter)

10.87 → 02.93	C 16 LZ / C 16 NZ		246-083-001-004C	SWP-D-C	T1: 1
---------------	-------------------	--	------------------	---------	-------

1.6 i (60 kW | 1.6 Liter)

07.89 → 02.93	16 SV		246-083-001-004C	SWP-D-C	T1: 1
---------------	-------	--	------------------	---------	-------

2.0 i (85 kW | 2.0 Liter)

10.86 → 02.93	20 NE	→ JE1000000; → J50000000; → J25000000	246-082-008-014C	SWP-M-C	T1: 1
---------------	-------	---------------------------------------------	------------------	---------	-------

10.86 → 02.93	20 NE		246-083-001-004C	SWP-D-C	T1: 1
---------------	-------	--	------------------	---------	-------



			VDO		
Datum	Motorcode	Fahrgestell Nr.	Artikel Nr.	Artikelbez.	Information

OPEL**KADETT E Cabriolet (43B_)****2.0 i KAT (85 kW | 2.0 Liter)**

10.86 → 02.93	C 20 NE		246-083-001-004C	SWP-D-C	T1: 1
---------------	---------	--	------------------	---------	-------

KADETT E Kasten (37_, 47_)**1.2 (40 kW | 1.2 Liter)**

09.84 → 07.86	12 SC		246-082-008-014C	SWP-M-C	T1: 1
---------------	-------	--	------------------	---------	-------

1.3 N (44 kW | 1.3 Liter)

09.84 → 12.86	13 N / 13 NB	→ JE100000; → J5000000; → J2500000	246-082-008-014C	SWP-M-C	T1: 1
---------------	--------------	------------------------------------------	------------------	---------	-------

1.6 i (55 kW | 1.6 Liter)

08.89 → 09.93	C 16 NZ	→ J5000000; → JE100000; → J2500000	246-082-008-014C	SWP-M-C	T1: 1
---------------	---------	------------------------------------------	------------------	---------	-------

1.8 i (66 kW | 1.8 Liter)

09.87 → 09.92	C 18 NT	→ J5000000; → JE100000; → J2500000	246-082-008-014C	SWP-M-C	T1: 1
---------------	---------	------------------------------------------	------------------	---------	-------

1.6 D (40 kW | 1.6 Liter)

08.84 → 12.86	16 D / 16 DA	→ J5000000; → J2500000; → JE100000	246-082-008-014C	SWP-M-C	T1: 1
---------------	--------------	------------------------------------------	------------------	---------	-------

KADETT E Combo (38_, 48_)**1.6 i (55 kW | 1.6 Liter)**

08.91 → 07.94	C 16 NZ	→ J5000000; → JE100000; → J2500000	246-082-008-014C	SWP-M-C	T1: 1
---------------	---------	------------------------------------------	------------------	---------	-------

1.6 D (40 kW | 1.6 Liter)

01.86 → 12.89	16 DA	→ J2500000; → J5000000; → JE100000	246-082-008-014C	SWP-M-C	T1: 1
---------------	-------	------------------------------------------	------------------	---------	-------

MANTA B (58_, 59_)**1.2 N (40 kW | 1.2 Liter)**

07.79 → 07.83	12 N	72500001 →; 71000001 →; 75000001 →	246-082-008-014C	SWP-M-C	T1: 1
---------------	------	------------------------------------------	------------------	---------	-------

1.3 N (44 kW | 1.3 Liter)

03.79 → 12.80	13 N		246-082-008-014C	SWP-M-C	T1: 1
---------------	------	--	------------------	---------	-------



			VDO		
Datum	Motorcode	Fahrgestell Nr.	Artikel Nr.	Artikelbez.	Information

OPEL**MANTA B (58_, 59_)****1.6 S (55 kW | 1.6 Liter)**

07.81 → 12.81	16 S	72500001 →; 71000001 →; 75000001 →	246-082-008-014C	SWP-M-C	T1: 1
---------------	------	------------------------------------------	------------------	---------	-------

1.9 N (55 kW | 1.9 Liter)

07.81 → 12.81	19 N	71000001 →; 72500001 →; 75000001 →	246-082-008-014C	SWP-M-C	T1: 1
---------------	------	------------------------------------------	------------------	---------	-------

1.9 S (66 kW | 1.9 Liter)

11.77 → 12.80	19 S	75000001 →; 72500001 →; 71000001 →	246-082-008-014C	SWP-M-C	T1: 1
---------------	------	------------------------------------------	------------------	---------	-------

2.0 (66 kW | 2.0 Liter)

12.77 → 12.80	20 N		246-082-008-014C	SWP-M-C	T1: 1
---------------	------	--	------------------	---------	-------

MANTA B CC (53_, 55_)**1.3 S (55 kW | 1.3 Liter)**

05.80 → 07.86	13 S		246-082-008-014C	SWP-M-C	T1: 1
---------------	------	--	------------------	---------	-------

1.8 S (66 kW | 1.8 Liter)

07.82 → 07.86	18 S		246-082-008-014C	SWP-M-C	T1: 1
---------------	------	--	------------------	---------	-------

2.0 (66 kW | 2.0 Liter)

12.77 → 12.80	20 N		246-082-008-014C	SWP-M-C	T1: 1
---------------	------	--	------------------	---------	-------

2.0 S (74 kW | 2.0 Liter)

08.81 → 07.84	20 S		246-082-008-014C	SWP-M-C	T1: 1
---------------	------	--	------------------	---------	-------

2.0 E (81 kW | 2.0 Liter)

08.84 → 08.88	20 E		246-082-008-014C	SWP-M-C	T1: 1
---------------	------	--	------------------	---------	-------

MONZA A (22_)**2.0 E (85 kW | 2.0 Liter)**

03.83 → 07.84	H 20 E		246-082-008-014C	SWP-M-C	T1: 1
---------------	--------	--	------------------	---------	-------

2.2 E (85 kW | 2.2 Liter)

11.84 → 08.86	22 E		246-082-008-014C	SWP-M-C	T1: 1
---------------	------	--	------------------	---------	-------

2.5 E (100 kW | 2.5 Liter)

06.81 → 08.86	H 25 E		246-082-008-014C	SWP-M-C	T1: 1
---------------	--------	--	------------------	---------	-------

2.8 (103 kW | 2.8 Liter)

06.78 → 04.81	28 H		246-082-008-014C	SWP-M-C	T1: 1
---------------	------	--	------------------	---------	-------

3.0 (110 kW | 3.0 Liter)

06.81 → 07.82	30 H		246-082-008-014C	SWP-M-C	T1: 1
---------------	------	--	------------------	---------	-------

3.0 GSE (115 kW | 3.0 Liter)

09.85 → 08.86	C 30 LE		246-082-008-014C	SWP-M-C	T1: 1
---------------	---------	--	------------------	---------	-------



			VDO		
Datum	Motorcode	Fahrgestell Nr.	Artikel Nr.	Artikelbez.	Information

OPEL**OMEGA A (16_, 17_, 19_)****1.8 N (60 kW | 1.8 Liter)**

10.86 → 08.87 | 18 NV | | 246-082-008-014C | SWP-M-C | T1: 1

1.8 (65 kW | 1.8 Liter)

09.87 → 07.90 | E 18 NVR | | 246-082-008-014C | SWP-M-C | T1: 1

1.8 (85 kW | 1.8 Liter)

10.86 → 02.94 | 18 SEH | | 246-082-008-014C | SWP-M-C | T1: 1

2.0 (73 kW | 2.0 Liter)

09.90 → 02.94 | C 20 NEJ | | 246-082-008-014C | SWP-M-C | T1: 1

2.0 (74 kW | 2.0 Liter)

09.90 → 02.94 | C 20 NEF | | 246-082-008-014C | SWP-M-C | T1: 1

2.0 (90 kW | 2.0 Liter)

10.86 → 07.93 | 20 SE | | 246-082-008-014C | SWP-M-C | T1: 1

2.4 i (92 kW | 2.4 Liter)

10.88 → 07.91 | C 24 NE | | 246-082-008-014C | SWP-M-C | T1: 1

2.6 i (110 kW | 2.6 Liter)

09.90 → 02.94 | C 26 NE | | 246-082-008-014C | SWP-M-C | T1: 1

3.0 (3000) (115 kW | 3.0 Liter)

03.87 → 12.87 | C 30 LE | | 246-082-008-014C | SWP-M-C | T1: 1

3.0 (3000) (130 kW | 3.0 Liter)

03.87 → 09.90 | 30 NE | | 246-082-008-014C | SWP-M-C | T1: 1

3.0 (3000) KAT (130 kW | 3.0 Liter)

08.90 → 02.94 | C 30 NE | | 246-082-008-014C | SWP-M-C | T1: 1

3.0 24V (3000) (147 kW | 3.0 Liter)

10.89 → 02.94 | C 30 SEJ | | 246-082-008-014C | SWP-M-C | T1: 1

3.6 24V Lotus (277 kW | 3.6 Liter)

08.90 → 09.92 | C 36 GET | | 246-082-008-014C | SWP-M-C | T1: 1

2.3 D (54 kW | 2.3 Liter)

10.86 → 02.94 | 23 YD | | 246-082-008-014C | SWP-M-C | T1: 1

2.3 TD (66 kW | 2.3 Liter)

10.86 → 08.88 | 23 YDT | | 246-082-008-014C | SWP-M-C | T1: 1

2.3 TD Interc. (74 kW | 2.3 Liter)

10.88 → 02.94 | 23 DTR | | 246-082-008-014C | SWP-M-C | T1: 1

OMEGA A Caravan (66_, 67_)**1.8 N (60 kW | 1.8 Liter)**

10.86 → 08.87 | 18 NV | | 246-082-008-014C | SWP-M-C | T1: 1

1.8 (65 kW | 1.8 Liter)

09.87 → 07.90 | E 18 NVR | | 246-082-008-014C | SWP-M-C | T1: 1

1.8 (85 kW | 1.8 Liter)

10.86 → 02.94 | 18 SEH | | 246-082-008-014C | SWP-M-C | T1: 1

2.0 (74 kW | 2.0 Liter)

09.90 → 02.94 | C 20 NEF | | 246-082-008-014C | SWP-M-C | T1: 1

2.0 i (85 kW | 2.0 Liter)

10.86 → 02.94 | C 20 NE | | 246-082-008-014C | SWP-M-C | T1: 1



			VDO		
Datum	Motorcode	Fahrgestell Nr.	Artikel Nr.	Artikelbez.	Information

OPEL**OMEGA A Caravan (66_, 67_)**

2.0 (90 kW 2.0 Liter)					
10.86 → 07.93	20 SE		246-082-008-014C	SWP-M-C	T1: 1
2.4 i (92 kW 2.4 Liter)					
10.88 → 07.91	C 24 NE		246-082-008-014C	SWP-M-C	T1: 1
2.6 i (110 kW 2.6 Liter)					
09.90 → 02.94	C 26 NE		246-082-008-014C	SWP-M-C	T1: 1
3.0 KAT (130 kW 3.0 Liter)					
03.87 → 02.94	C 30 NE		246-082-008-014C	SWP-M-C	T1: 1
3.0 24V (147 kW 3.0 Liter)					
10.89 → 02.94	C 30 SEJ		246-082-008-014C	SWP-M-C	T1: 1
2.3 D (54 kW 2.3 Liter)					
10.86 → 02.94	23 YD		246-082-008-014C	SWP-M-C	T1: 1
2.3 TD (66 kW 2.3 Liter)					
10.86 → 08.88	23 YDT		246-082-008-014C	SWP-M-C	T1: 1
2.3 TD Interc. (74 kW 2.3 Liter)					
10.88 → 02.94	23 DTR		246-082-008-014C	SWP-M-C	T1: 1

OMEGA B (25_, 26_, 27_)

2.0 (85 kW 2.0 Liter)					
03.94 → 12.00	20 SE	Y-1-000-001 →; → 2-1-022-530	246-082-008-021G	SWP-M-C	T1: 6
2.0 (85 kW 2.0 Liter)					
03.94 → 06.99	X 20 SE	→ X1999999	246-082-008-014C	SWP-M-C	T1: 1
03.94 → 09.99	X 20 SE	Y-1-000-001 →; → 2-1-022-530	246-082-008-021G	SWP-M-C	T1: 6
2.0 16V (100 kW 2.0 Liter)					
03.94 → 06.99	X 20 XEV		246-082-008-014C	SWP-M-C	T1: 1
03.94 → 09.99	X 20 XEV	Y-1-000-001 →; → 2-1-022-530	246-082-008-021G	SWP-M-C	T1: 6
2.2 16V (106 kW 2.2 Liter)					
09.99 → 07.03	Y 22 XE / Z 22 XE	Y-1-000-001 →; → 2-1-022-530	246-082-008-021G	SWP-M-C	T1: 6
2.5 V6 (125 kW 2.5 Liter)					
03.94 → 06.99	X 25 XE	→ X1999999	246-082-008-014C	SWP-M-C	T1: 1
03.94 → 09.00	X 25 XE	Y-1-000-001 →; → 2-1-022-530	246-082-008-021G	SWP-M-C	T1: 6
2.6 V6 (132 kW 2.6 Liter)					
09.00 → 07.03	Y 26 SE	Y-1-000-001 →; → 2-1-022-530	246-082-008-021G	SWP-M-C	T1: 6
3.0 V6 (155 kW 3.0 Liter)					
04.94 → 06.99	X 30 XE	→ X1999999	246-082-008-014C	SWP-M-C	T1: 1
04.94 → 02.01	X 30 XE	Y-1-000-001 →; → 2-1-022-530	246-082-008-021G	SWP-M-C	T1: 6



			VDO		
Datum	Motorcode	Fahrgestell Nr.	Artikel Nr.	Artikelbez.	Information

OPEL**OMEGA B (25_, 26_, 27_)****3.2 V6 (160 kW | 3.2 Liter)**

02.01 → 07.03	Y 32 SE	Y-1-000-001 →; → 2-1-022-530	246-082-008-021G	SWP-M-C	T1: 6
---------------	---------	---------------------------------	------------------	---------	-------

2.0 DTI 16V (74 kW | 2.0 Liter)

09.97 → 09.00	X 20 DTH	Y-1-000-001 →; → 2-1-022-530	246-082-008-021G	SWP-M-C	T1: 6
---------------	----------	---------------------------------	------------------	---------	-------

2.2 DTI 16V (88 kW | 2.2 Liter)

09.00 → 07.03	Y 22 DTH	Y-1-000-001 →; → 2-1-022-530	246-082-008-021G	SWP-M-C	T1: 6
---------------	----------	---------------------------------	------------------	---------	-------

2.5 TD (96 kW | 2.5 Liter)

04.94 → 06.99	25 DT / X 25 DT / X 25 TD	→ X1999999	246-082-008-014C	SWP-M-C	T1: 1
04.94 → 07.03	25 DT / X 25 DT / X 25 TD	Y-1-000-001 →; → 2-1-022-530	246-082-008-021G	SWP-M-C	T1: 6

2.5 DTI (110 kW | 2.5 Liter)

09.01 → 07.03	Y 25 DT	Y-1-000-001 →; → 2-1-022-530	246-082-008-021G	SWP-M-C	T1: 6
---------------	---------	---------------------------------	------------------	---------	-------

OMEGA B Caravan (21_, 22_, 23_)**2.0 (85 kW | 2.0 Liter)**

03.94 → 09.99	X 20 SE		246-083-001-004C	SWP-D-C	T1: 1
03.94 → 09.99	X 20 SE	Y-1-000-001 →; → 2-1-022-530	246-083-002-014G	SWP-D-C	T1: 6

2.0 16V (100 kW | 2.0 Liter)

03.94 → 09.99	X 20 XEV		246-083-001-004C	SWP-D-C	T1: 1
03.94 → 09.99	X 20 XEV	Y-1-000-001 →; → 2-1-022-530	246-083-002-014G	SWP-D-C	T1: 6

2.2 16V (106 kW | 2.2 Liter)

09.99 → 07.03	Y 22 XE / Z 22 XE		246-083-001-004C	SWP-D-C	T1: 1
09.99 → 07.03	Y 22 XE / Z 22 XE	Y-1-000-001 →; → 2-1-022-530	246-083-002-014G	SWP-D-C	T1: 6

2.5 V6 (125 kW | 2.5 Liter)

03.94 → 09.00	X 25 XE		246-083-001-004C	SWP-D-C	T1: 1
03.94 → 09.00	X 25 XE	Y-1-000-001 →; → 2-1-022-530	246-083-002-014G	SWP-D-C	T1: 6

2.6 V6 (132 kW | 2.6 Liter)

09.00 → 07.03	Y 26 SE		246-083-001-004C	SWP-D-C	T1: 1
09.00 → 07.03	Y 26 SE	Y-1-000-001 →; → 2-1-022-530	246-083-002-014G	SWP-D-C	T1: 6

3.0 V6 (155 kW | 3.0 Liter)

04.94 → 02.01	X 30 XE		246-083-001-004C	SWP-D-C	T1: 1
04.94 → 02.01	X 30 XE	Y-1-000-001 →; → 2-1-022-530	246-083-002-014G	SWP-D-C	T1: 6



			VDO		
Datum	Motorcode	Fahrgestell Nr.	Artikel Nr.	Artikelbez.	Information

OPEL**OMEGA B Caravan (21_, 22_, 23_)**

3.2 V6 (160 kW 3.2 Liter)					
02.01 → 07.03	Y 32 SE		246-083-001-004C	SWP-D-C	T1: 1
02.01 → 07.03	Y 32 SE	Y-1-000-001 →; → 2-1-022-530	246-083-002-014G	SWP-D-C	T1: 6
2.0 DTI 16V (74 kW 2.0 Liter)					
09.97 → 09.00	X 20 DTH		246-083-001-004C	SWP-D-C	T1: 1
09.97 → 09.00	X 20 DTH	Y-1-000-001 →; → 2-1-022-530	246-083-002-014G	SWP-D-C	T1: 6
2.2 DTI 16V (88 kW 2.2 Liter)					
09.00 → 07.03	Y 22 DTH		246-083-001-004C	SWP-D-C	T1: 1
09.00 → 07.03	Y 22 DTH	Y-1-000-001 →; → 2-1-022-530	246-083-002-014G	SWP-D-C	T1: 6
2.5 TD (96 kW 2.5 Liter)					
04.94 → 02.01	25 DT / X 25 DT / X 25 TD		246-083-001-004C	SWP-D-C	T1: 1
04.94 → 02.01	25 DT / X 25 DT / X 25 TD	Y-1-000-001 →; → 2-1-022-530	246-083-002-014G	SWP-D-C	T1: 6
2.5 DTI (110 kW 2.5 Liter)					
09.01 → 07.03	Y 25 DT		246-083-001-004C	SWP-D-C	T1: 1
09.01 → 07.03	Y 25 DT	Y-1-000-001 →; → 2-1-022-530	246-083-002-014G	SWP-D-C	T1: 6

REKORD D

1.7 (44 kW 1.7 Liter)					
08.77 → 08.77	17 N	71000001 →	246-082-008-014C	SWP-M-C	T1: 1
1.9 (55 kW 1.9 Liter)					
08.77 → 08.77	19 N	71000001 →	246-082-008-014C	SWP-M-C	T1: 1
2.0 (74 kW 2.0 Liter)					
08.77 → 08.77	20 S	71000001 →	246-082-008-014C	SWP-M-C	T1: 1
2.0 D (40 kW 2.0 Liter)					
08.77 → 08.77	20 D	71000001 →	246-082-008-014C	SWP-M-C	T1: 1
2.1 D (44 kW 2.1 Liter)					
08.77 → 08.77	21 D	71000001 →	246-082-008-014C	SWP-M-C	T1: 1

REKORD D Caravan

2.0 S (74 kW 2.0 Liter)					
08.77 → 08.77	20 S		246-082-008-014C	SWP-M-C	T1: 1

REKORD E (17_-19_, 11_, 14_, 16_)

1.7 (44 kW 1.7 Liter)					
09.77 → 07.81	17 N		246-082-008-014C	SWP-M-C	T1: 1
1.8 (55 kW 1.8 Liter)					
11.82 → 07.84	18 N		246-082-008-014C	SWP-M-C	T1: 1



			VDO		
Datum	Motorcode	Fahrgestell Nr.	Artikel Nr.	Artikelbez.	Information

OPEL**REKORD E (17_, 19_, 11_, 14_, 16_)**

1.8 S (66 kW 1.8 Liter)					
11.82 → 08.86	18 S		246-082-008-014C	SWP-M-C	T1: 1
1.9 (55 kW 1.9 Liter)					
09.77 → 09.82	19 N		246-082-008-014C	SWP-M-C	T1: 1
2.0 (66 kW 2.0 Liter)					
09.77 → 10.82	20 N		246-082-008-014C	SWP-M-C	T1: 1
2.0 S (74 kW 2.0 Liter)					
10.82 → 08.86	20 S		246-082-008-014C	SWP-M-C	T1: 1
2.0 E (81 kW 2.0 Liter)					
10.82 → 07.84	20 E		246-082-008-014C	SWP-M-C	T1: 1
2.2 E (85 kW 2.2 Liter)					
11.84 → 08.86	22 E		246-082-008-014C	SWP-M-C	T1: 1
2.0 D (43 kW 2.0 Liter)					
09.77 → 12.81	20 D		246-082-008-014C	SWP-M-C	T1: 1
2.1 D (44 kW 2.1 Liter)					
09.77 → 07.78	21 D		246-082-008-014C	SWP-M-C	T1: 1
2.2 D (48 kW 2.2 Liter)					
08.78 → 08.83	23 D		246-082-008-014C	SWP-M-C	T1: 1
2.2 D (52 kW 2.2 Liter)					
08.84 → 08.86	23 D		246-082-008-014C	SWP-M-C	T1: 1
2.2 TD (63 kW 2.2 Liter)					
08.84 → 08.86	23 TD		246-082-008-014C	SWP-M-C	T1: 1

REKORD E Caravan (61_, 66_, 67_)

1.7 (44 kW 1.7 Liter)					
09.77 → 07.81	17 N		246-082-008-014C	SWP-M-C	T1: 1
1.8 (55 kW 1.8 Liter)					
11.82 → 07.84	18 N		246-082-008-014C	SWP-M-C	T1: 1
1.8 S (66 kW 1.8 Liter)					
11.82 → 08.86	18 S		246-082-008-014C	SWP-M-C	T1: 1
1.9 (55 kW 1.9 Liter)					
09.77 → 09.82	19 N		246-082-008-014C	SWP-M-C	T1: 1
2.0 S (74 kW 2.0 Liter)					
08.84 → 08.86	20 S		246-082-008-014C	SWP-M-C	T1: 1
2.0 E (81 kW 2.0 Liter)					
10.82 → 07.84	20 E		246-082-008-014C	SWP-M-C	T1: 1
2.2 E (85 kW 2.2 Liter)					
11.84 → 08.86	22 E		246-082-008-014C	SWP-M-C	T1: 1
2.0 D (43 kW 2.0 Liter)					
09.77 → 12.81	20 D		246-082-008-014C	SWP-M-C	T1: 1
2.1 D (44 kW 2.1 Liter)					
09.77 → 07.78	21 D		246-082-008-014C	SWP-M-C	T1: 1
2.2 D (48 kW 2.2 Liter)					
08.78 → 08.83	23 D		246-082-008-014C	SWP-M-C	T1: 1



			VDO		
Datum	Motorcode	Fahrgestell Nr.	Artikel Nr.	Artikelbez.	Information

OPEL**REKORD E Caravan (61_, 66_, 67_)****2.3 D (52 kW | 2.3 Liter)**

08.84 → 08.86 23 D 246-082-008-014C SWP-M-C T1: 1

2.2 TD (63 kW | 2.2 Liter)

08.84 → 08.86 23 TD 246-082-008-014C SWP-M-C T1: 1

SENATOR A (29_)**2.0 E (85 kW | 2.0 Liter)**

03.83 → 07.84 H 20 E 246-082-008-014C SWP-M-C T1: 1

2.2 E (85 kW | 2.2 Liter)

11.84 → 02.87 22 E 246-082-008-014C SWP-M-C T1: 1

2.5 E (100 kW | 2.5 Liter)

01.83 → 08.84 H 25 E 246-082-008-014C SWP-M-C T1: 1

2.8 (103 kW | 2.8 Liter)

06.78 → 04.81 28 H 246-082-008-014C SWP-M-C T1: 1

3.0 (110 kW | 3.0 Liter)

06.78 → 07.82 30 H 246-082-008-014C SWP-M-C T1: 1

3.0 (115 kW | 3.0 Liter)

09.85 → 08.87 C 30 LE 246-082-008-014C SWP-M-C T1: 1

2.2 TD (63 kW | 2.2 Liter)

11.84 → 02.87 23 TD 246-082-008-014C SWP-M-C T1: 1

SENATOR B (29_)**2.6 i (110 kW | 2.6 Liter)**

09.90 → 06.93 C 26 NE 246-082-008-014C SWP-M-C T1: 1

3.0 (115 kW | 3.0 Liter)

09.87 → 06.93 C 30 LE 246-082-008-014C SWP-M-C T1: 1

3.0 (130 kW | 3.0 Liter)

01.88 → 09.90 30 NE 246-082-008-014C SWP-M-C T1: 1

3.0 24V (150 kW | 3.0 Liter)

10.89 → 06.93 C 30 SE 246-082-008-014C SWP-M-C T1: 1

TIGRA (95_)**1.4 16V (63 kW | 1.4 Liter)**

08.97 → 12.00 X 14 XE 246-083-001-004C SWP-D-C T1: 1

1.4 16V (66 kW | 1.4 Liter)

07.94 → 12.00 X 14 XE 246-082-008-021G SWP-M-C T1: 6

07.94 → 12.00 X 14 XE 246-083-001-004C SWP-D-C T1: 1

07.95 → 12.00 X 14 XE 246-083-002-014G SWP-D-C T1: 6; T10

1.6 16V (74 kW | 1.6 Liter)

08.97 → 08.98 C 16 SEL 246-083-001-004C SWP-D-C T1: 1



			VDO		
Datum	Motorcode	Fahrgestell Nr.	Artikel Nr.	Artikelbez.	Information

OPEL**TIGRA (95_)****1.6 16V (78 kW | 1.6 Liter)**

07.94 → 08.98	X 16 XE		246-082-008-021G	SWP-M-C	T1: 6
07.94 → 08.98	X 16 XE		246-083-001-004C	SWP-D-C	T1: 1
07.95 → 08.98	X 16 XE		246-083-002-014G	SWP-D-C	T1: 6; T10

VECTRA A CC (88_, 89_)**1.4 S (55 kW | 1.4 Liter)**

04.88 → 06.92	14 NV		246-083-001-004C	SWP-D-C	T1: 1
---------------	-------	--	------------------	---------	-------

1.6 i (52 kW | 1.6 Liter)

09.93 → 11.95	X 16 SZ		246-083-001-004C	SWP-D-C	T1: 1
---------------	---------	--	------------------	---------	-------

1.6 i (55 kW | 1.6 Liter)

09.93 → 11.95	16 LZ2		246-083-001-004C	SWP-D-C	T1: 1
---------------	--------	--	------------------	---------	-------

1.6 i KAT (55 kW | 1.6 Liter)

09.88 → 11.95	C 16 NZ / C 16 NZ2		246-083-001-004C	SWP-D-C	T1: 1
---------------	--------------------	--	------------------	---------	-------

1.6 S (60 kW | 1.6 Liter)

09.88 → 05.93	16 SV		246-083-001-004C	SWP-D-C	T1: 1
---------------	-------	--	------------------	---------	-------

1.8 S (65 kW | 1.8 Liter)

09.88 → 07.89	E 18 NVR		246-083-001-004C	SWP-D-C	T1: 1
---------------	----------	--	------------------	---------	-------

1.8 i (66 kW | 1.8 Liter)

09.88 → 10.90	18 SV		246-083-001-004C	SWP-D-C	T1: 1
---------------	-------	--	------------------	---------	-------

1.8 i KAT (66 kW | 1.8 Liter)

03.90 → 11.95	C 18 NZ		246-083-001-004C	SWP-D-C	T1: 1
---------------	---------	--	------------------	---------	-------

2.0 (74 kW | 2.0 Liter)

04.88 → 09.89	C 20 NEF		246-083-001-004C	SWP-D-C	T1: 1
---------------	----------	--	------------------	---------	-------

2.0 i (85 kW | 2.0 Liter)

09.88 → 10.90	20 NE		246-083-001-004C	SWP-D-C	T1: 1
---------------	-------	--	------------------	---------	-------

2.0 i KAT (85 kW | 2.0 Liter)

09.88 → 11.95	C 20 NE		246-083-001-004C	SWP-D-C	T1: 1
---------------	---------	--	------------------	---------	-------

2.0 i GT (95 kW | 2.0 Liter)

09.88 → 11.95	20 SEH		246-083-001-004C	SWP-D-C	T1: 1
---------------	--------	--	------------------	---------	-------

2.0 i 16V (100 kW | 2.0 Liter)

06.94 → 11.95	X 20 XEV		246-083-001-004C	SWP-D-C	T1: 1
---------------	----------	--	------------------	---------	-------

2.0 i 16V (110 kW | 2.0 Liter)

02.89 → 10.90	20 XEJ		246-083-001-004C	SWP-D-C	T1: 1
---------------	--------	--	------------------	---------	-------

2.0 i 16V KAT (110 kW | 2.0 Liter)

02.90 → 11.95	C 20 XE		246-083-001-004C	SWP-D-C	T1: 1
---------------	---------	--	------------------	---------	-------

2.5 V6 (125 kW | 2.5 Liter)

02.93 → 11.95	C 25 XE		246-083-001-004C	SWP-D-C	T1: 1
---------------	---------	--	------------------	---------	-------





1.7 D (42 kW | 1.7 Liter)

09.88 → 09.92	17 D		246-083-001-004C	SWP-D-C	T1: 1
---------------	------	--	------------------	---------	-------

1.7 D (44 kW | 1.7 Liter)

07.92 → 11.95	17 DR		246-083-001-004C	SWP-D-C	T1: 1
---------------	-------	--	------------------	---------	-------



			VDO		
Datum	Motorcode	Fahrgestell Nr.	Artikel Nr.	Artikelbez.	Information

OPEL**VECTRA A CC (88_, 89_)****1.7 TD (60 kW | 1.7 Liter)**

03.90 → 11.95	17 DT (TC4EE1) / X 17 DT (TC4EE1)		246-083-001-004C	SWP-D-C	T1: 1
---------------	--------------------------------------	--	------------------	---------	-------

VECTRA A (86_, 87_)**1.4 S (55 kW | 1.4 Liter)**

09.88 → 06.92	14 NV		246-082-008-014C	SWP-M-C	T1: 1
---------------	-------	--	------------------	---------	-------

1.6 i (52 kW | 1.6 Liter)

09.93 → 09.95	X 16 SZ		246-082-008-014C	SWP-M-C	T1: 1
---------------	---------	--	------------------	---------	-------

1.6 i (55 kW | 1.6 Liter)

09.88 → 10.90	E 16 NZ		246-082-008-014C	SWP-M-C	T1: 1
---------------	---------	--	------------------	---------	-------

1.6 i KAT (55 kW | 1.6 Liter)

09.88 → 09.95	C 16 NZ / C 16 NZ2		246-082-008-014C	SWP-M-C	T1: 1
---------------	--------------------	--	------------------	---------	-------

1.8 S 4x4 (65 kW | 1.8 Liter)

01.89 → 07.89	E 18 NVR		246-082-008-014C	SWP-M-C	T1: 1
---------------	----------	--	------------------	---------	-------

1.8 i KAT (66 kW | 1.8 Liter)

03.90 → 09.95	C 18 NZ		246-082-008-014C	SWP-M-C	T1: 1
---------------	---------	--	------------------	---------	-------

2.0 i KAT (85 kW | 2.0 Liter)

07.92 → 09.95	C 20 NE		246-082-008-014C	SWP-M-C	T1: 1
---------------	---------	--	------------------	---------	-------

2.0 i 4x4 (85 kW | 2.0 Liter)

01.89 → 10.90	20 NE		246-082-008-014C	SWP-M-C	T1: 1
---------------	-------	--	------------------	---------	-------

2.0 i 4x4 KAT (85 kW | 2.0 Liter)

07.92 → 09.95	C 20 NE		246-082-008-014C	SWP-M-C	T1: 1
---------------	---------	--	------------------	---------	-------

2.0 i (95 kW | 2.0 Liter)

09.88 → 07.92	20 SEH		246-082-008-014C	SWP-M-C	T1: 1
---------------	--------	--	------------------	---------	-------

2.0 i 4x4 (95 kW | 2.0 Liter)

01.89 → 07.92	20 SEH		246-082-008-014C	SWP-M-C	T1: 1
---------------	--------	--	------------------	---------	-------

2.0 i 16V (100 kW | 2.0 Liter)

06.94 → 09.95	X 20 XEV		246-082-008-014C	SWP-M-C	T1: 1
---------------	----------	--	------------------	---------	-------

2000/GT 16V (110 kW | 2.0 Liter)

03.90 → 06.94	20 XEJ		246-082-008-014C	SWP-M-C	T1: 1
---------------	--------	--	------------------	---------	-------

2000 16V 4x4 (110 kW | 2.0 Liter)

01.89 → 10.90	20 XEJ		246-082-008-014C	SWP-M-C	T1: 1
---------------	--------	--	------------------	---------	-------

2.0 i Turbo 4x4 (150 kW | 2.0 Liter)

06.94 → 09.95	C 20 LET		246-082-008-014C	SWP-M-C	T1: 1
---------------	----------	--	------------------	---------	-------

2.5 V6 (125 kW | 2.5 Liter)

05.93 → 09.95	C 25 XE		246-082-008-014C	SWP-M-C	T1: 1
---------------	---------	--	------------------	---------	-------

1.7 D (42 kW | 1.7 Liter)

10.88 → 06.92	17 D		246-082-008-014C	SWP-M-C	T1: 1
---------------	------	--	------------------	---------	-------

1.7 D (44 kW | 1.7 Liter)

07.92 → 09.95	17 DR		246-082-008-014C	SWP-M-C	T1: 1
---------------	-------	--	------------------	---------	-------

1.7 TD (60 kW | 1.7 Liter)

07.91 → 09.95	17 DT (TC4EE1) / X 17 DT (TC4EE1)		246-082-008-014C	SWP-M-C	T1: 1
---------------	--------------------------------------	--	------------------	---------	-------



			VDO		
Datum	Motorcode	Fahrgestell Nr.	Artikel Nr.	Artikelbez.	Information

OPEL**VECTRA B CC (38_)**

1.6 i (55 kW 1.6 Liter)					
10.95 → 01.99	X 16 SZR		246-083-002-014G	SWP-D-C	T1: 6
1.6 i 16V (74 kW 1.6 Liter)					
10.95 → 01.99	X 16 XEL / Y 16 XE / Z 16 XE		246-083-002-014G	SWP-D-C	T1: 6
1.8 i 16V (85 kW 1.8 Liter)					
10.95 → 01.99	X 18 XE / X 18 XE1		246-083-002-014G	SWP-D-C	T1: 6
2.0 i 16V (100 kW 2.0 Liter)					
10.95 → 01.99	X 20 XEV		246-083-002-014G	SWP-D-C	T1: 6
2.5 i V6 (125 kW 2.5 Liter)					
10.95 → 01.99	X 25 XE		246-083-002-014G	SWP-D-C	T1: 6
1.7 TD (60 kW 1.7 Liter)					
10.95 → 12.98	X 17 DT (TC4EE1)		246-083-002-014G	SWP-D-C	T1: 6
2.0 DI 16V (60 kW 2.0 Liter)					
11.96 → 01.99	X 20 DTL		246-083-002-014G	SWP-D-C	T1: 6
2.0 DTI 16V (74 kW 2.0 Liter)					
09.97 → 01.99	X 20 DTH / Y 20 DTH		246-083-002-014G	SWP-D-C	T1: 6

VECTRA B (36_)

1.6 i (55 kW 1.6 Liter)					
10.95 → 01.99	X 16 SZR		246-082-008-021G	SWP-M-C	T1: 6
1.6 i 16V (74 kW 1.6 Liter)					
10.95 → 01.99	X 16 XEL / Y 16 XE / Z 16 XE		246-082-008-021G	SWP-M-C	T1: 6
1.8 i 16V (85 kW 1.8 Liter)					
10.95 → 01.99	X 18 XE / X 18 XE1		246-082-008-021G	SWP-M-C	T1: 6
2.0 i 16V (100 kW 2.0 Liter)					
10.95 → 01.99	X 20 XEV		246-082-008-021G	SWP-M-C	T1: 6
i 500 2.5 (143 kW 2.5 Liter)					
05.98 → 01.99	X 25 XE		246-082-008-021G	SWP-M-C	T1: 6
1.7 TD (60 kW 1.7 Liter)					
10.95 → 12.98	X 17 DT (TC4EE1)		246-082-008-021G	SWP-M-C	T1: 6
2.0 DI 16V (60 kW 2.0 Liter)					
11.96 → 01.99	X 20 DTL		246-082-008-021G	SWP-M-C	T1: 6
2.0 DTI 16V (74 kW 2.0 Liter)					
09.97 → 01.99	X 20 DTH / Y 20 DTH		246-082-008-021G	SWP-M-C	T1: 6

VECTRA B Caravan (31_)

1.6 i (55 kW 1.6 Liter)					
11.96 → 01.99	X 16 SZR		246-083-002-014G	SWP-D-C	T1: 6
1.8 i 16V (85 kW 1.8 Liter)					
11.96 → 01.99	X 18 XE / X 18 XE1		246-083-002-014G	SWP-D-C	T1: 6
2.0 i 16V (100 kW 2.0 Liter)					
11.96 → 01.99	X 20 XEV		246-083-002-014G	SWP-D-C	T1: 6



			VDO		
Datum	Motorcode	Fahrgestell Nr.	Artikel Nr.	Artikelbez.	Information

OPEL**VECTRA B Caravan (31_)****i 500 2.5 (143 kW | 2.5 Liter)**

05.98 → 01.99	X 25 XE		246-083-002-014G	SWP-D-C	T1: 6
---------------	---------	--	------------------	---------	-------

2.0 DI 16V (60 kW | 2.0 Liter)

11.96 → 01.99	X 20 DTL		246-083-002-014G	SWP-D-C	T1: 6
---------------	----------	--	------------------	---------	-------

2.0 DTI 16V (74 kW | 2.0 Liter)

09.97 → 01.99	X 20 DTH / Y 20 DTH		246-083-002-014G	SWP-D-C	T1: 6
---------------	---------------------	--	------------------	---------	-------

VECTRA C GTS**1.8 16V (90 kW | 1.8 Liter)**

08.02 →	Z 18 XE		246-082-008-021G	SWP-M-C	T1: 6
---------	---------	--	------------------	---------	-------

08.02 →	Z 18 XE		246-083-002-014G	SWP-D-C	T1: 6; T5: 5
---------	---------	--	------------------	---------	--------------

2.2 16V (108 kW | 2.2 Liter)

08.02 →	Z 22 SE		246-082-008-021G	SWP-M-C	T1: 6
---------	---------	--	------------------	---------	-------

08.02 →	Z 22 SE		246-083-002-014G	SWP-D-C	T1: 6; T5: 5
---------	---------	--	------------------	---------	--------------

3.2 V6 (155 kW | 3.2 Liter)

08.02 →	Z 32 SE		246-082-008-021G	SWP-M-C	T1: 6
---------	---------	--	------------------	---------	-------

08.02 →	Z 32 SE		246-083-002-014G	SWP-D-C	T1: 6; T5: 5
---------	---------	--	------------------	---------	--------------

2.0 DTI 16V (74 kW | 2.0 Liter)

08.02 →	Y 20 DTH		246-082-008-021G	SWP-M-C	T1: 6
---------	----------	--	------------------	---------	-------

08.02 →	Y 20 DTH		246-083-002-014G	SWP-D-C	T1: 6; T5: 5
---------	----------	--	------------------	---------	--------------

2.2 DTI 16V (92 kW | 2.2 Liter)

08.02 →	Y 22 DTR		246-082-008-021G	SWP-M-C	T1: 6
---------	----------	--	------------------	---------	-------

08.02 →	Y 22 DTR		246-083-002-014G	SWP-D-C	T1: 6; T5: 5
---------	----------	--	------------------	---------	--------------

VECTRA C**1.8 16V (90 kW | 1.8 Liter)**

04.02 →	Z 18 XE		246-082-008-021G	SWP-M-C	T1: 6
---------	---------	--	------------------	---------	-------

04.02 →	Z 18 XE		246-083-002-014G	SWP-D-C	T1: 6; T5: 5
---------	---------	--	------------------	---------	--------------

2.2 16V (108 kW | 2.2 Liter)

04.02 →	Z 22 SE		246-082-008-021G	SWP-M-C	T1: 6
---------	---------	--	------------------	---------	-------

04.02 →	Z 22 SE		246-083-002-014G	SWP-D-C	T1: 6; T5: 5
---------	---------	--	------------------	---------	--------------

2.0 DTI 16V (74 kW | 2.0 Liter)

04.02 →	Y 20 DTH		246-082-008-021G	SWP-M-C	T1: 6
---------	----------	--	------------------	---------	-------

04.02 →	Y 20 DTH		246-083-002-014G	SWP-D-C	T1: 6; T5: 5
---------	----------	--	------------------	---------	--------------

2.2 DTI 16V (92 kW | 2.2 Liter)





04.02 →	Y 22 DTR		246-082-008-021G	SWP-M-C	T1: 6
---------	----------	--	------------------	---------	-------

04.02 →	Y 22 DTR		246-083-002-014G	SWP-D-C	T1: 6; T5: 5
---------	----------	--	------------------	---------	--------------

ZAFIRA (F75_)**1.6 CNG (71 kW | 1.6 Liter)**

09.01 →	Z 16 YNG		246-083-002-014G	SWP-D-C	T1: 6
---------	----------	--	------------------	---------	-------



			VDO		
Datum	Motorcode	Fahrgestell Nr.	Artikel Nr.	Artikelbez.	Information

OPEL**ZAFIRA (F75_)****1.6 16V (74 kW | 1.6 Liter)**

04.99 → X 16 XEL / Z 16 XE 246-082-008-021G SWP-M-C T1: 6

04.99 → X 16 XEL / Z 16 XE 246-083-002-014G SWP-D-C T1: 6

1.8 16V (85 kW | 1.8 Liter)

08.00 → 09.00 X 18 XE1 246-082-008-021G SWP-M-C T1: 6

04.99 → 09.00 X 18 XE1 246-083-002-014G SWP-D-C T1: 6

1.8 16V (92 kW | 1.8 Liter)

09.00 → Z 18 XE 246-083-002-014G SWP-D-C T1: 6

2.0 OPC (141 kW | 2.0 Liter)

09.01 → Z 20 LET 246-083-002-014G SWP-D-C T1: 6

2.2 16V (108 kW | 2.2 Liter)

09.00 → Z 22 SE 246-083-002-014G SWP-D-C T1: 6

2.0 DI 16V (60 kW | 2.0 Liter)

10.99 → X 20 DTL 246-082-008-021G SWP-M-C T1: 6

10.99 → X 20 DTL 246-083-002-014G SWP-D-C T1: 6

2.0 DTI 16V (74 kW | 2.0 Liter)

09.00 → Y 20 DTH 246-083-002-014G SWP-D-C T1: 6

PEUGEOT**106 I (1A, 1C)****1.0 (33 kW | 1.0 Liter)**

09.91 → 04.96 CDY (TU9M) X10-729-002-007 SWP-M-C T1: 11

1.0 (37 kW | 1.0 Liter)

09.91 → 04.96 X10-729-002-007 SWP-M-C T1: 11

1.1 (44 kW | 1.1 Liter)

09.91 → 04.96 HDZ (TU1M) X10-729-002-007 SWP-M-C T1: 11

1.3 (72 kW | 1.3 Liter)

10.93 → 04.96 TU2J2 X10-729-002-007 SWP-M-C T1: 11

1.4 (55 kW | 1.4 Liter)

09.91 → 04.96 KDX (TU3MC) / KDY (TU3M) X10-729-002-007 SWP-M-C T1: 11

1.4 (69 kW | 1.4 Liter)

09.91 → 04.96 KFZ (TU3J2/Z) X10-729-002-007 SWP-M-C T1: 11

1.6 (65 kW | 1.6 Liter)

06.93 → 04.96 NFZ (TU5JP) X10-729-002-007 SWP-M-C T1: 11

1.6 (76 kW | 1.6 Liter)

01.94 → 04.96 NFY (TU5J2) X10-729-002-007 SWP-M-C T1: 11

1.4 D (37 kW | 1.4 Liter)

09.92 → 04.96 K9Y (TUD3Y) X10-729-002-007 SWP-M-C T1: 11





1.5 D (40 kW | 1.5 Liter)

06.94 → 04.96 VJY (TUD5) X10-729-002-007 SWP-M-C T1: 11

1.5 D (43 kW | 1.5 Liter)

06.94 → 04.96 X10-729-002-007 SWP-M-C T1: 11



			VDO		
Datum	Motorcode	Fahrgestell Nr.	Artikel Nr.	Artikelbez.	Information

PEUGEOT

206 CC (2D)

1.6 16V (80 kW | 1.6 Liter)

09.00 →	NFU (TU5JP4)		X10-729-002-007	SWP-M-C	T1: 11
---------	--------------	--	-----------------	---------	--------

2.0 S16 (100 kW | 2.0 Liter)

09.00 →	RFN (EW10J4)		X10-729-002-007	SWP-M-C	T1: 11
---------	--------------	--	-----------------	---------	--------

306 Schrägheck (7A, 7C, N3, N5)

1.1 (44 kW | 1.1 Liter)

04.97 →	HDZ (TU1M)		X10-729-002-007	SWP-M-C	T1: 11; T7: XN →
---------	------------	--	-----------------	---------	------------------

1.4 (55 kW | 1.4 Liter)

04.97 →	KDX (TU3MC) / KFW (TU3JP) / KFX (TU3JP)		X10-729-002-007	SWP-M-C	T1: 11; T7: XN →
---------	--------------------------------------------	--	-----------------	---------	------------------

1.6 (65 kW | 1.6 Liter)

04.97 → 10.00	NFZ (TU5JP)		X10-729-002-007	SWP-M-C	T1: 11; T7: XN →
---------------	-------------	--	-----------------	---------	------------------

1.6 (72 kW | 1.6 Liter)

10.00 →	NFT		X10-729-002-007	SWP-M-C	T1: 11; T7: XN →
---------	-----	--	-----------------	---------	------------------

1.8 (74 kW | 1.8 Liter)

04.97 →	LFZ (XU7JP)		X10-729-002-007	SWP-M-C	T1: 11; T7: XN →
---------	-------------	--	-----------------	---------	------------------

1.8 16V (81 kW | 1.8 Liter)

04.97 →	LFY (XU7JP4)		X10-729-002-007	SWP-M-C	T1: 11; T7: XN →
---------	--------------	--	-----------------	---------	------------------

2.0 XSi (89 kW | 2.0 Liter)

04.97 →	RFX (XU10J2)		X10-729-002-007	SWP-M-C	T1: 11; T7: XN →
---------	--------------	--	-----------------	---------	------------------

2.0 16V (97 kW | 2.0 Liter)

04.97 →	RFV (XU10J4R)		X10-729-002-007	SWP-M-C	T1: 11; T7: XN →
---------	---------------	--	-----------------	---------	------------------

2.0 S16 (110 kW | 2.0 Liter)

04.97 →	RFT (XU10J4)		X10-729-002-007	SWP-M-C	T1: 11; T7: XN →
---------	--------------	--	-----------------	---------	------------------

2.0 S16 (112 kW | 2.0 Liter)

04.97 →	RFY (XU10J4Z)		X10-729-002-007	SWP-M-C	T1: 11; T7: XN →
---------	---------------	--	-----------------	---------	------------------

2.0 S16 (120 kW | 2.0 Liter)

04.97 →	RFS (XU10J4RS)		X10-729-002-007	SWP-M-C	T1: 11; T7: XN →
---------	----------------	--	-----------------	---------	------------------

1.8 D (43 kW | 1.8 Liter)

04.97 →	A9A (XUD7)		X10-729-002-007	SWP-M-C	T1: 11; T7: XN →
---------	------------	--	-----------------	---------	------------------

1.9 D (51 kW | 1.9 Liter)

09.98 →	WJY (DW8B) / WJZ (DW8)		X10-729-002-007	SWP-M-C	T1: 11; T7: XN →
---------	------------------------	--	-----------------	---------	------------------

1.9 D (47 kW | 1.9 Liter)

04.97 →	DJZ (XUD9Y)		X10-729-002-007	SWP-M-C	T1: 11; T7: XN →
---------	-------------	--	-----------------	---------	------------------

1.9 D (50 kW | 1.9 Liter)

04.97 →	DJY (XUD9A)		X10-729-002-007	SWP-M-C	T1: 11; T7: XN →
---------	-------------	--	-----------------	---------	------------------

1.9 D (55 kW | 1.9 Liter)

03.98 →	DHV (XUD9BSD)		X10-729-002-007	SWP-M-C	T1: 11; T7: XN →
---------	---------------	--	-----------------	---------	------------------

1.9 DT (66 kW | 1.9 Liter)

04.97 →	DHY (XUD9TE)		X10-729-002-007	SWP-M-C	T1: 11; T7: XN →
---------	--------------	--	-----------------	---------	------------------

2.0 HDI 90 (66 kW | 2.0 Liter)

06.99 →	RHY (DW10TD)		X10-729-002-007	SWP-M-C	T1: 11; T7: XN →
---------	--------------	--	-----------------	---------	------------------



			VDO		
Datum	Motorcode	Fahrgestell Nr.	Artikel Nr.	Artikelbez.	Information

PEUGEOT**306 (7B, N3, N5)****1.1 (44 kW | 1.1 Liter)**

04.97 → HDZ (TU1M) X10-729-002-007 SWP-M-C T1: 11; T7: XN →

1.4 SL (55 kW | 1.4 Liter)

04.97 → KDX (TU3MC) / KFW (TU3JP) / KFX (TU3JP) X10-729-002-007 SWP-M-C T1: 11; T7: XN →

1.6 SR (65 kW | 1.6 Liter)

04.97 → 10.00 NFZ (TU5JP) X10-729-002-007 SWP-M-C T1: 11; T7: XN →

1.6 (72 kW | 1.6 Liter)

10.00 → NFT X10-729-002-007 SWP-M-C T1: 11; T7: XN →

1.8 ST (74 kW | 1.8 Liter)

04.97 → LFZ (XU7JP) X10-729-002-007 SWP-M-C T1: 11; T7: XN →

1.8 16V (81 kW | 1.8 Liter)

04.97 → LFY (XU7JP4) X10-729-002-007 SWP-M-C T1: 11; T7: XN →

2.0 ST (89 kW | 2.0 Liter)

04.97 → RFX (XU10J2) X10-729-002-007 SWP-M-C T1: 11; T7: XN →

2.0 (97 kW | 2.0 Liter)

04.97 → RFV (XU10J4R) X10-729-002-007 SWP-M-C T1: 11; T7: XN →

2.0 S16 (110 kW | 2.0 Liter)

04.97 → RFT (XU10J4) X10-729-002-007 SWP-M-C T1: 11; T7: XN →

2.0 S16 (112 kW | 2.0 Liter)

04.97 → RFY (XU10J4Z) X10-729-002-007 SWP-M-C T1: 11; T7: XN →

1.9 D (51 kW | 1.9 Liter)

09.98 → WJY (DW8B) / WJZ (DW8) X10-729-002-007 SWP-M-C T1: 11; T7: XN →

1.9 SLD (47 kW | 1.9 Liter)

04.97 → DJZ (XUD9Y) X10-729-002-007 SWP-M-C T1: 11; T7: XN →

1.9 SLD (50 kW | 1.9 Liter)

04.97 → DJY (XUD9A) X10-729-002-007 SWP-M-C T1: 11; T7: XN →

1.9 D (55 kW | 1.9 Liter)

03.98 → DHV (XUD9BSD) X10-729-002-007 SWP-M-C T1: 11; T7: XN →

1.9 SRDT (66 kW | 1.9 Liter)

04.97 → DHY (XUD9TE) X10-729-002-007 SWP-M-C T1: 11; T7: XN →

2.0 HDI 90 (66 kW | 2.0 Liter)

06.99 → RHY (DW10TD) X10-729-002-007 SWP-M-C T1: 11; T7: XN →

306 Cabriolet (7D, N3, N5)**1.6 (65 kW | 1.6 Liter)**

04.96 → 10.00 NFZ (TU5JP) X10-729-002-007 SWP-M-C T1: 11

1.6 (72 kW | 1.6 Liter)

10.00 → NFT X10-729-002-007 SWP-M-C T1: 11

1.8 (74 kW | 1.8 Liter)

03.94 → LFZ (XU7JP) X10-729-002-007 SWP-M-C T1: 11

1.8 16V (81 kW | 1.8 Liter)

07.00 → LFY (XU7JP4) X10-729-002-007 SWP-M-C T1: 11



			VDO		
Datum	Motorcode	Fahrgestell Nr.	Artikel Nr.	Artikelbez.	Information

PEUGEOT

306 Cabriolet (7D, N3, N5)

2.0 (89 kW | 2.0 Liter)

03.94 →	RFX (XU10J2)		X10-729-002-007	SWP-M-C	T1: 11
---------	--------------	--	-----------------	---------	--------

2.0 16V (97 kW | 2.0 Liter)

03.97 →	RFV (XU10J4R)		X10-729-002-007	SWP-M-C	T1: 11
---------	---------------	--	-----------------	---------	--------

406 (8B)

1.6 (65 kW | 1.6 Liter)

11.95 → 05.04	BFZ (XU5JP)		X10-729-002-007	SWP-M-C	T1: 11
---------------	-------------	--	-----------------	---------	--------

1.8 16V (85 kW | 1.8 Liter)

10.00 → 05.04	6FZ (EW7J4)		X10-729-002-007	SWP-M-C	T1: 11
---------------	-------------	--	-----------------	---------	--------

1.8 (66 kW | 1.8 Liter)

05.97 → 05.04	LFX (XU7JB)		X10-729-002-007	SWP-M-C	T1: 11
---------------	-------------	--	-----------------	---------	--------

1.8 16V (81 kW | 1.8 Liter)

11.95 → 10.00	LFY (XU7JP4)		X10-729-002-007	SWP-M-C	T1: 11
---------------	--------------	--	-----------------	---------	--------

2.0 16V (99 kW | 2.0 Liter)

01.99 → 08.00	RFR (DEW10J4)		X10-729-002-007	SWP-M-C	T1: 11
---------------	---------------	--	-----------------	---------	--------

2.0 16V (100 kW | 2.0 Liter)

08.00 → 05.04	RFN (EW10J4)		X10-729-002-007	SWP-M-C	T1: 11
---------------	--------------	--	-----------------	---------	--------

2.0 16V HPI (103 kW | 2.0 Liter)

05.01 → 05.04	RLZ (EW10D)		X10-729-002-007	SWP-M-C	T1: 11
---------------	-------------	--	-----------------	---------	--------

2.0 16V (97 kW | 2.0 Liter)

11.95 → 05.04	RFV (XU10J4R)		X10-729-002-007	SWP-M-C	T1: 11
---------------	---------------	--	-----------------	---------	--------

2.0 Turbo (108 kW | 2.0 Liter)

04.96 → 05.04	RGX (XU10J2TE)		X10-729-002-007	SWP-M-C	T1: 11
---------------	----------------	--	-----------------	---------	--------

2.2 (116 kW | 2.2 Liter)

07.00 → 05.04	3FZ (EW12J4)		X10-729-002-007	SWP-M-C	T1: 11
---------------	--------------	--	-----------------	---------	--------

3.0 24V (140 kW | 3.0 Liter)

10.96 → 05.04	XFZ (ES9J4)		X10-729-002-007	SWP-M-C	T1: 11
---------------	-------------	--	-----------------	---------	--------

3.0 V6 (152 kW | 3.0 Liter)

03.00 → 05.04	XFX (ES9J4S)		X10-729-002-007	SWP-M-C	T1: 11
---------------	--------------	--	-----------------	---------	--------

1.9 D (55 kW | 1.9 Liter)

10.96 → 05.04	DHW (XUD9SD)		X10-729-002-007	SWP-M-C	T1: 11
---------------	--------------	--	-----------------	---------	--------

1.9 TD (66 kW | 1.9 Liter)

01.96 → 05.04	DHX (XUD9TE)		X10-729-002-007	SWP-M-C	T1: 11
---------------	--------------	--	-----------------	---------	--------

1.9 TD (68 kW | 1.9 Liter)

01.96 → 05.04	DHY (XUD9TE)		X10-729-002-007	SWP-M-C	T1: 11
---------------	--------------	--	-----------------	---------	--------

2.0 HDI 90 (66 kW | 2.0 Liter)

02.99 → 05.04	RHY (DW10TD)		X10-729-002-007	SWP-M-C	T1: 11
---------------	--------------	--	-----------------	---------	--------

2.0 HDi 110 FAP (79 kW | 2.0 Liter)

08.01 → 05.04	RHS (DW10ATED4)		X10-729-002-007	SWP-M-C	T1: 11
---------------	-----------------	--	-----------------	---------	--------

2.0 HDI 110 (80 kW | 2.0 Liter)

06.98 → 08.01	RHZ (DW10ATED)		X10-729-002-007	SWP-M-C	T1: 11
---------------	----------------	--	-----------------	---------	--------

2.1 TD 12V (80 kW | 2.1 Liter)

01.96 → 05.04	P8C (XUD11BTE)		X10-729-002-007	SWP-M-C	T1: 11
---------------	----------------	--	-----------------	---------	--------



			VDO		
Datum	Motorcode	Fahrgestell Nr.	Artikel Nr.	Artikelbez.	Information

PEUGEOT**406 (8B)****2.2 HDi FAP (98 kW | 2.2 Liter)**

03.00 → 05.04	4HX (DW12TED4/FAP)		X10-729-002-007	SWP-M-C	T1: 11
---------------	--------------------	--	-----------------	---------	--------

406 Break (8E/F)**1.8 16V (85 kW | 1.8 Liter)**

10.00 →	6FZ (EW7J4)		X10-729-002-007	SWP-M-C	T1: 11
---------	-------------	--	-----------------	---------	--------

1.8 (66 kW | 1.8 Liter)

05.97 →	LFX (XU7JB)		X10-729-002-007	SWP-M-C	T1: 11
---------	-------------	--	-----------------	---------	--------

1.8 16V (81 kW | 1.8 Liter)

10.96 → 10.00	LFY (XU7JP4)		X10-729-002-007	SWP-M-C	T1: 11
---------------	--------------	--	-----------------	---------	--------

2.0 16V (99 kW | 2.0 Liter)

01.99 → 10.00	RFR (DEW10J4)		X10-729-002-007	SWP-M-C	T1: 11
---------------	---------------	--	-----------------	---------	--------

2.0 16V (100 kW | 2.0 Liter)

10.00 →	RFN (EW10J4)		X10-729-002-007	SWP-M-C	T1: 11
---------	--------------	--	-----------------	---------	--------

2.0 16V HPi (103 kW | 2.0 Liter)

05.01 →	RLZ (EW10D)		X10-729-002-007	SWP-M-C	T1: 11
---------	-------------	--	-----------------	---------	--------

2.0 16V (97 kW | 2.0 Liter)

10.96 →	RFV (XU10J4R)		X10-729-002-007	SWP-M-C	T1: 11
---------	---------------	--	-----------------	---------	--------

2.0 Turbo (108 kW | 2.0 Liter)

10.96 →	RGX (XU10J2TE)		X10-729-002-007	SWP-M-C	T1: 11
---------	----------------	--	-----------------	---------	--------

2.2 (116 kW | 2.2 Liter)

07.00 →	3FZ (EW12J4)		X10-729-002-007	SWP-M-C	T1: 11
---------	--------------	--	-----------------	---------	--------

3.0 24V (140 kW | 3.0 Liter)

10.96 →	XFZ (ES9J4)		X10-729-002-007	SWP-M-C	T1: 11
---------	-------------	--	-----------------	---------	--------

3.0 V6 (152 kW | 3.0 Liter)

03.00 →	AFX (ES9J4S)		X10-729-002-007	SWP-M-C	T1: 11
---------	--------------	--	-----------------	---------	--------

1.9 D (55 kW | 1.9 Liter)

10.96 →	DHW (XUD9SD)		X10-729-002-007	SWP-M-C	T1: 11
---------	--------------	--	-----------------	---------	--------

1.9 TD (66 kW | 1.9 Liter)

10.96 →	DHX (XUD9TE)		X10-729-002-007	SWP-M-C	T1: 11
---------	--------------	--	-----------------	---------	--------

2.0 HDI 90 (66 kW | 2.0 Liter)

02.99 →	RHY (DW10TD)		X10-729-002-007	SWP-M-C	T1: 11
---------	--------------	--	-----------------	---------	--------

2.0 HDi 110 FAP (79 kW | 2.0 Liter)

08.01 →	RHS (DW10ATED4)		X10-729-002-007	SWP-M-C	T1: 11
---------	-----------------	--	-----------------	---------	--------

2.0 HDi 110 (80 kW | 2.0 Liter)

02.99 → 04.04	RHZ (DW10ATED)		X10-729-002-007	SWP-M-C	T1: 11
---------------	----------------	--	-----------------	---------	--------





2.1 TD 12V (80 kW | 2.1 Liter)

10.96 →	P8C (XUD11BTE)		X10-729-002-007	SWP-M-C	T1: 11
---------	----------------	--	-----------------	---------	--------

2.2 HDi FAP (98 kW | 2.2 Liter)

03.00 →	4HX (DW12TED4/FAP)		X10-729-002-007	SWP-M-C	T1: 11
---------	--------------------	--	-----------------	---------	--------



			VDO		
Datum	Motorcode	Fahrgestell Nr.	Artikel Nr.	Artikelbez.	Information

PEUGEOT





406 Coupe (8C)

2.0 16V (99 kW 2.0 Liter)					
01.99 → 10.00	RFR (DEW10J4)		X10-729-002-007	SWP-M-C	T1: 11
2.0 16V (100 kW 2.0 Liter)					
10.00 →	RFN (EW10J4)		X10-729-002-007	SWP-M-C	T1: 11
2.0 16V (97 kW 2.0 Liter)					
03.97 →	RFV (XU10J4R)		X10-729-002-007	SWP-M-C	T1: 11
2.2 (116 kW 2.2 Liter)					
03.02 →	3FZ (EW12J4)		X10-729-002-007	SWP-M-C	T1: 11
3.0 V6 24V (140 kW 3.0 Liter)					
03.97 →	XFZ (ES9J4)		X10-729-002-007	SWP-M-C	T1: 11
3.0 V6 (152 kW 3.0 Liter)					
03.00 →	XFX (ES9J4S)		X10-729-002-007	SWP-M-C	T1: 11
2.2 HDI FAP (98 kW 2.2 Liter)					
03.00 →	4HX (DW12TED4/FAP)		X10-729-002-007	SWP-M-C	T1: 11

605 (6B)

2.0 (79 kW 2.0 Liter)					
02.90 → 09.99			X10-729-002-007	SWP-M-C	T1: 11; T7: SL →
2.0 (84 kW 2.0 Liter)					
06.89 → 09.99	R5A (XU102C)		X10-729-002-007	SWP-M-C	T1: 11; T7: SL →
2.0 (89 kW 2.0 Liter)					
06.89 → 09.99	RFZ (XU10J2Z)		X10-729-002-007	SWP-M-C	T1: 11; T7: SL →
2.0 16V (97 kW 2.0 Liter)					
07.94 → 09.99	RFV (XU10J4R)		X10-729-002-007	SWP-M-C	T1: 11; T7: SL →
2.0 Turbo (104 kW 2.0 Liter)					
07.92 → 09.99	RGY (XU10J2TE)		X10-729-002-007	SWP-M-C	T1: 11; T7: SL →
2.0 Turbo (108 kW 2.0 Liter)					
07.91 → 09.99	RGX (XU10J2TE)		X10-729-002-007	SWP-M-C	T1: 11; T7: SL →
3.0 (123 kW 3.0 Liter)					
10.89 → 09.99	UFZ (ZPJ)		X10-729-002-007	SWP-M-C	T1: 11; T7: SL →
3.0 V6 (140 kW 3.0 Liter)					
04.97 → 09.99			X10-729-002-007	SWP-M-C	T1: 11; T7: SL →
3.0 SV 24 (147 kW 3.0 Liter)					
08.89 → 09.99	UKZ (ZPJ4/Z)		X10-729-002-007	SWP-M-C	T1: 11; T7: SL →
2.1 Turbo Diesel (80 kW 2.1 Liter)					
06.89 → 09.99	PHZ (XUD11ATE)		X10-729-002-007	SWP-M-C	T1: 11; T7: SL →
2.1 TD 12V (80 kW 2.1 Liter)					
08.94 → 09.99	P8C (XUD11BTE)		X10-729-002-007	SWP-M-C	T1: 11; T7: SL →
2.1 D (60 kW 2.1 Liter)					
06.89 → 07.95	P9A (XUD11A)		X10-729-002-007	SWP-M-C	T1: 11; T7: SL →
2.5 Turbo Diesel (95 kW 2.5 Liter)					
07.94 → 09.99	THY (DK5ATE)		X10-729-002-007	SWP-M-C	T1: 11; T7: SL →



			VDO		
Datum	Motorcode	Fahrgestell Nr.	Artikel Nr.	Artikelbez.	Information

PEUGEOT

EXPERT (224)

1.6 (58 kW | 1.6 Liter)

02.96 →	222A2 (1580 SPI)		X10-729-002-007	SWP-M-C	T1: 11
---------	------------------	--	-----------------	---------	--------

2.0 (100 kW | 2.0 Liter)

07.00 →	RFN (EW10J4)		X10-729-002-007	SWP-M-C	T1: 11
---------	--------------	--	-----------------	---------	--------

1.9 D (51 kW | 1.9 Liter)

02.96 →	D9B (XUD9AU)		X10-729-002-007	SWP-M-C	T1: 11
---------	--------------	--	-----------------	---------	--------

1.9 TD (66 kW | 1.9 Liter)

02.96 →	DHX (XUD9TE)		X10-729-002-007	SWP-M-C	T1: 11
---------	--------------	--	-----------------	---------	--------

1.9 TD (68 kW | 1.9 Liter)

02.96 →	D8B (XUD9TE)		X10-729-002-007	SWP-M-C	T1: 11
---------	--------------	--	-----------------	---------	--------

2.0 HDI (80 kW | 2.0 Liter)

07.00 →	RHZ (DW10ATED)		X10-729-002-007	SWP-M-C	T1: 11
---------	----------------	--	-----------------	---------	--------

EXPERT Kasten (222)

1.6 (58 kW | 1.6 Liter)

02.96 →	222A2 (1580 SPI)		X10-729-002-007	SWP-M-C	T1: 11
---------	------------------	--	-----------------	---------	--------

1.9 D (51 kW | 1.9 Liter)

02.96 →	D9B (XUD9AU)		X10-729-002-007	SWP-M-C	T1: 11
---------	--------------	--	-----------------	---------	--------

1.9 TD (66 kW | 1.9 Liter)

02.96 →	DHX (XUD9TE)		X10-729-002-007	SWP-M-C	T1: 11
---------	--------------	--	-----------------	---------	--------

1.9 TD (68 kW | 1.9 Liter)

02.96 →	D8B (XUD9TE)		X10-729-002-007	SWP-M-C	T1: 11
---------	--------------	--	-----------------	---------	--------

2.0 HDI (69 kW | 2.0 Liter)

07.00 →	RHX (DW10BTED)		X10-729-002-007	SWP-M-C	T1: 11
---------	----------------	--	-----------------	---------	--------

2.0 HDI (80 kW | 2.0 Liter)

07.00 →	RHZ (DW10ATED)		X10-729-002-007	SWP-M-C	T1: 11
---------	----------------	--	-----------------	---------	--------

PARTNER Kasten (5)

1.1 (44 kW | 1.1 Liter)

06.96 →	HDZ (TU1M)		X10-729-002-007	SWP-M-C	T1: 11
---------	------------	--	-----------------	---------	--------

1.4 (55 kW | 1.4 Liter)

06.96 →	KFX (TU3JP)		X10-729-002-007	SWP-M-C	T1: 11
---------	-------------	--	-----------------	---------	--------

1.8 D (43 kW | 1.8 Liter)

06.96 →	A9A (XUD7)		X10-729-002-007	SWP-M-C	T1: 11
---------	------------	--	-----------------	---------	--------

1.9 D (51 kW | 1.9 Liter)

06.96 →	DJY (XUD9A)		X10-729-002-007	SWP-M-C	T1: 11
---------	-------------	--	-----------------	---------	--------

2.0 HDi (66 kW | 2.0 Liter)

04.00 →	RHY (DW10TD)		X10-729-002-007	SWP-M-C	T1: 11
---------	--------------	--	-----------------	---------	--------



			VDO		
Datum	Motorcode	Fahrgestell Nr.	Artikel Nr.	Artikelbez.	Information

PORSCHE

911

2.0 T (81 kW 2.0 Liter)					
08.68 → 02.72	901.03 / 901.13		246-075-015-001C	SWP-M-G	T1: 1; T2: A
2.2 T (92 kW 2.2 Liter)					
01.70 → 12.72			246-075-015-001C	SWP-M-G	T1: 1; T2: A
2.3 T (96 kW 2.3 Liter)					
01.72 → 12.73			246-075-015-001C	SWP-M-G	T1: 1; T2: A
2.3 T (103 kW 2.3 Liter)					
08.71 → 12.73			246-075-015-001C	SWP-M-G	T1: 1; T2: A
2.3 S (140 kW 2.3 Liter)					
08.71 → 01.76	911.53 / 911.63		246-075-015-001C	SWP-M-G	T1: 1; T2: A
2.7 (121 kW 2.7 Liter)					
09.75 → 06.77			246-075-015-001C	SWP-M-G	T1: 1; T2: A
3.2 (160 kW 3.2 Liter)					
08.86 → 08.89	930.25		246-075-015-001C	SWP-M-G	T1: 1; T2: A

911 Targa

2.0 T (81 kW 2.0 Liter)					
06.67 → 02.72	901.03 / 901.13		246-075-015-001C	SWP-M-G	T1: 1; T2: A
2.2 T (92 kW 2.2 Liter)					
01.70 → 12.72			246-075-015-001C	SWP-M-G	T1: 1; T2: A
2.3 T (96 kW 2.3 Liter)					
01.72 → 12.73			246-075-015-001C	SWP-M-G	T1: 1; T2: A





911 (964)

3.3 Turbo (235 kW 3.3 Liter)					
08.90 → 09.93	M 30.69		246-082-008-025G	SWP-M-C	T1: 3
3.6 Carrera (184 kW 3.6 Liter)					
07.89 → 09.93	M 64.01 / M 64.02		246-075-042-001C	SWP-M-G	T1: 1
08.92 → 09.93	M 64.01 / M 64.02		246-082-008-025G	SWP-M-C	T1: 3
3.6 Carrera 4 (184 kW 3.6 Liter)					
12.88 → 09.93	M 64.01		246-082-008-025G	SWP-M-C	T1: 3
3.6 Carrera RS (191 kW 3.6 Liter)					
06.91 → 09.93	64.03		246-082-008-025G	SWP-M-C	T1: 3
3.6 Turbo (265 kW 3.6 Liter)					
01.93 → 09.93	M 64.50		246-082-008-025G	SWP-M-C	T1: 3

911 Cabriolet (964)

3.6 Carrera (184 kW 3.6 Liter)					
08.92 → 05.94	M 64.01 / M 64.02		246-082-008-025G	SWP-M-C	T1: 3



			VDO		
Datum	Motorcode	Fahrgestell Nr.	Artikel Nr.	Artikelbez.	Information

PORSCHE**911 (993)****3.6 Carrera (200 kW | 3.6 Liter)**

10.93 → 08.95	M 64.05 / M 64.06 / M 64.07 / M 64.08		246-082-008-025G	SWP-M-C	T1: 3
---------------	------------------------------------------	--	------------------	---------	-------

3.6 Carrera 4 (200 kW | 3.6 Liter)

07.94 → 08.95	M 64.05 / M 64.07		246-082-008-025G	SWP-M-C	T1: 3
---------------	-------------------	--	------------------	---------	-------

3.6 Carrera (210 kW | 3.6 Liter)

08.95 → 09.97	M 64.21 / M 64.22 / M 64.23 / M 64.24		246-082-008-025G	SWP-M-C	T1: 3
---------------	------------------------------------------	--	------------------	---------	-------

3.6 Carrera 4 (210 kW | 3.6 Liter)

08.95 → 09.97	M 64.21 / M 64.23		246-082-008-025G	SWP-M-C	T1: 3
---------------	-------------------	--	------------------	---------	-------

3.6 Turbo 4 (300 kW | 3.6 Liter)

03.95 → 09.97	M 64.60		246-082-008-025G	SWP-M-C	T1: 3
---------------	---------	--	------------------	---------	-------

3.6 Turbo GT2 (316 kW | 3.6 Liter)

03.95 → 09.97	M 64.60R		246-082-008-025G	SWP-M-C	T1: 3
---------------	----------	--	------------------	---------	-------

3.6 Turbo GT2 4 (316 kW | 3.6 Liter)

08.95 → 09.97	M 64.60R		246-082-008-025G	SWP-M-C	T1: 3
---------------	----------	--	------------------	---------	-------

3.6 Turbo GT2 4 (331 kW | 3.6 Liter)

06.97 → 09.97			246-082-008-025G	SWP-M-C	T1: 3
---------------	--	--	------------------	---------	-------

3.8 Carrera (210 kW | 3.8 Liter)

06.95 → 09.97	M 64.05S / M 64.06S		246-082-008-025G	SWP-M-C	T1: 3
---------------	---------------------	--	------------------	---------	-------

3.8 Carrera 4 (210 kW | 3.8 Liter)

06.95 → 09.97	M 64.05S / M 64.06S		246-082-008-025G	SWP-M-C	T1: 3
---------------	---------------------	--	------------------	---------	-------

3.8 Carrera RS (221 kW | 3.8 Liter)

06.95 → 09.97	M 64.20		246-082-008-025G	SWP-M-C	T1: 3
---------------	---------	--	------------------	---------	-------

3.8 Carrera RS 4 (221 kW | 3.8 Liter)

08.95 → 09.97	M 64.20		246-082-008-025G	SWP-M-C	T1: 3
---------------	---------	--	------------------	---------	-------

911 Targa (993)**3.6 Carrera (210 kW | 3.6 Liter)**

08.95 → 09.97	M 64.21 / M 64.22 / M 64.23 / M 64.24		246-082-008-025G	SWP-M-C	T1: 3
---------------	------------------------------------------	--	------------------	---------	-------

3.7 Carrera (221 kW | 3.7 Liter)

05.96 → 09.97	M 64.20		246-082-008-025G	SWP-M-C	T1: 3
---------------	---------	--	------------------	---------	-------

911 Cabriolet (993)**3.6 Carrera (200 kW | 3.6 Liter)**

07.94 → 08.95	M 64.05 / M 64.06 / M 64.07 / M 64.08		246-082-008-025G	SWP-M-C	T1: 3
---------------	------------------------------------------	--	------------------	---------	-------

3.6 Carrera 4 (200 kW | 3.6 Liter)

07.94 → 08.95	M 64.05 / M 64.07		246-082-008-025G	SWP-M-C	T1: 3
---------------	-------------------	--	------------------	---------	-------

3.6 Carrera (210 kW | 3.6 Liter)

08.95 → 09.97	M 64.21 / M 64.22 / M 64.23 / M 64.24		246-082-008-025G	SWP-M-C	T1: 3
---------------	------------------------------------------	--	------------------	---------	-------



			VDO		
Datum	Motorcode	Fahrgestell Nr.	Artikel Nr.	Artikelbez.	Information

PORSCHE**911 Cabriolet (993)**

3.6 Carrera 4 (210 kW 3.6 Liter)					
08.95 → 09.97	M 64.21 M 64.23		246-082-008-025G	SWP-M-C	T1: 3
3.8 Carrera (210 kW 3.8 Liter)					
06.95 → 09.97	M 64.05S M 64.06S		246-082-008-025G	SWP-M-C	T1: 3
3.8 Carrera 4 (210 kW 3.8 Liter)					
06.95 → 09.97	M 64.05S M 64.06S		246-082-008-025G	SWP-M-C	T1: 3
3.8 Carrera RS (221 kW 3.8 Liter)					
08.95 → 09.97	M 64.21S		246-082-008-025G	SWP-M-C	T1: 3
3.8 Carrera RS 4 (221 kW 3.8 Liter)					
08.95 → 09.97	M 64.21S		246-082-008-025G	SWP-M-C	T1: 3

911 (996)

3.4 Carrera (221 kW 3.4 Liter)					
09.97 → 09.01	M 96.01 M 96.04		246-082-008-025G	SWP-M-C	T1: 3
09.97 → 09.01	M 96.01 M 96.04		246-086-001-002C	HLWP	T1: 3
3.4 Carrera 4 (221 kW 3.4 Liter)					
06.97 → 09.01	M 96.01 M 96.04		246-082-008-025G	SWP-M-C	T1: 3
06.97 → 09.01	M 96.01 M 96.04		246-086-001-002C	HLWP	T1: 3
3.4 Carrera (235 kW 3.4 Liter)					
05.01 →			246-082-008-025G	SWP-M-C	T1: 3
05.01 →			246-086-001-002C	HLWP	T1: 3
3.4 Carrera 4 (235 kW 3.4 Liter)					
05.01 →			246-082-008-025G	SWP-M-C	T1: 3
05.01 →			246-086-001-002C	HLWP	T1: 3
3.6 Carrera (235 kW 3.6 Liter)					
10.01 →	M 96.03		246-082-008-025G	SWP-M-C	T1: 3
10.01 →	M 96.03		246-086-001-002C	HLWP	T1: 3
3.6 Carrera 4S (235 kW 3.6 Liter)					
10.01 →	M 96.03		246-082-008-025G	SWP-M-C	T1: 3
10.01 →	M 96.03		246-086-001-002C	HLWP	T1: 3
3.6 GT3 (265 kW 3.6 Liter)					
03.99 →	M 96.76		246-082-008-025G	SWP-M-C	T1: 3
03.99 →	M 96.76		246-086-001-002C	HLWP	T1: 3
3.6 Turbo 4 (309 kW 3.6 Liter)					
06.00 →	M 96.70		246-082-008-025G	SWP-M-C	T1: 3
06.00 →	M 96.70		246-086-001-002C	HLWP	T1: 3
3.6 GT2 (340 kW 3.6 Liter)					
04.01 →			246-082-008-025G	SWP-M-C	T1: 3
04.01 →			246-086-001-002C	HLWP	T1: 3

911 Cabriolet (996)

3.4 Carrera (221 kW 3.4 Liter)					
02.98 → 09.01	M 96.01 M 96.04		246-082-008-025G	SWP-M-C	T1: 3



			VDO		
Datum	Motorcode	Fahrgestell Nr.	Artikel Nr.	Artikelbez.	Information

PORSCHE

911 Cabriolet (996)

3.4 Carrera (235 kW | 3.4 Liter)

05.01 →			246-082-008-025G	SWP-M-C	T1: 3
---------	--	--	------------------	---------	-------

3.4 Carrera 4 (235 kW | 3.4 Liter)

05.01 →			246-082-008-025G	SWP-M-C	T1: 3
---------	--	--	------------------	---------	-------

3.6 Carrera (235 kW | 3.6 Liter)

10.01 →	M 96.03		246-082-008-025G	SWP-M-C	T1: 3
---------	---------	--	------------------	---------	-------

3.6 Carrera 4S (235 kW | 3.6 Liter)

10.01 →	M 96.03		246-082-008-025G	SWP-M-C	T1: 3
---------	---------	--	------------------	---------	-------

914

1.7 (59 kW | 1.7 Liter)

01.69 → 12.73	W		246-075-015-001C	SWP-M-G	T1: 1; T2: A
---------------	---	--	------------------	---------	--------------

924

2.0 (92 kW | 2.0 Liter)

11.75 → 08.89	XJ		246-075-021-006C	SWP-M-G	T1: 1; T2: B
---------------	----	--	------------------	---------	--------------

08.87 → 08.89	XJ		246-075-042-001C	SWP-M-G	T1: 1
---------------	----	--	------------------	---------	-------

2.0 Turbo (125 kW | 2.0 Liter)

11.78 → 06.80	M 31.01		246-075-021-006C	SWP-M-G	T1: 1; T2: B
---------------	---------	--	------------------	---------	--------------

2.0 Turbo (130 kW | 2.0 Liter)

06.80 → 10.86	M 31.03		246-075-021-006C	SWP-M-G	T1: 1; T2: B
---------------	---------	--	------------------	---------	--------------

2.0 Carrera GT (154 kW | 2.0 Liter)

06.80 → 10.86	M 31.50		246-075-021-006C	SWP-M-G	T1: 1; T2: B
---------------	---------	--	------------------	---------	--------------

2.5 S (110 kW | 2.5 Liter)

09.85 → 07.87	M 44.07 / M 44.08		246-075-021-006C	SWP-M-G	T1: 1; T2: B
---------------	-------------------	--	------------------	---------	--------------

2.5 S (118 kW | 2.5 Liter)

08.87 → 07.88	M 44.09 / M 44.10		246-075-021-006C	SWP-M-G	T1: 1; T2: B
---------------	-------------------	--	------------------	---------	--------------

2.5 S (120 kW | 2.5 Liter)

10.81 → 12.84	M 44.01 / M 44.03		246-075-021-006C	SWP-M-G	T1: 1; T2: B
---------------	-------------------	--	------------------	---------	--------------

928

4.4 (177 kW | 4.4 Liter)

09.77 → 08.82			246-075-015-001C	SWP-M-G	T1: 1; T2: A
---------------	--	--	------------------	---------	--------------

09.77 → 08.82		- F - 848 409 →; → - H - 840 626	246-075-042-001C	SWP-M-G	T1: 1
---------------	--	-------------------------------------	------------------	---------	-------

5.4 GTS (257 kW | 5.4 Liter)

08.91 → 11.95	M 28.49 / M 28.50	- P - 800 061 →	246-082-008-025G	SWP-M-C	T1: 3
---------------	-------------------	-----------------	------------------	---------	-------



			VDO		
Datum	Motorcode	Fahrgestell Nr.	Artikel Nr.	Artikelbez.	Information

PORSCHE**944**

2.5 (110 kW 2.5 Liter)					
01.85 → 07.87	M 44.02 / M 44.04 / M 44.07 / M 44.08		246-075-021-006C	SWP-M-G	T1: 1; T2: B
2.5 (118 kW 2.5 Liter)					
08.87 → 12.90	M 44.05 / M 44.09 / M 44.10		246-075-021-006C	SWP-M-G	T1: 1; T2: B
08.87 → 12.90	M 44.05 / M 44.09 / M 44.10		246-075-042-001C	SWP-M-G	T1: 1
2.5 (120 kW 2.5 Liter)					
06.81 → 07.87	M 44.01 / M 44.03 / M 44.05 / M 44.06		246-075-021-006C	SWP-M-G	T1: 1; T2: B
2.5 S (140 kW 2.5 Liter)					
08.86 → 07.88	M 44.40		246-075-021-006C	SWP-M-G	T1: 1; T2: B
2.5 Turbo (162 kW 2.5 Liter)					
08.85 → 07.88	M 44.50 / M 44.51		246-075-021-006C	SWP-M-G	T1: 1; T2: B
2.5 Turbo (184 kW 2.5 Liter)					
09.87 → 07.91	M 44.52		246-075-021-006C	SWP-M-G	T1: 1; T2: B
2.7 (121 kW 2.7 Liter)					
11.88 → 08.89	M 44.11 / M 44.12		246-075-021-006C	SWP-M-G	T1: 1; T2: B
11.88 → 08.89	M 44.11 / M 44.12		246-075-042-001C	SWP-M-G	T1: 1
3.0 S2 (155 kW 3.0 Liter)					
12.88 → 07.91	M 44.41		246-075-021-006C	SWP-M-G	T1: 1; T2: B

944 Cabriolet

3.0 S2 (155 kW 3.0 Liter)					
12.88 → 07.91	M 44.41		246-075-021-006C	SWP-M-G	T1: 1; T2: B

BOXSTER (986)

2.5 (150 kW 2.5 Liter)					
09.96 → 08.99	M 96.20		246-082-008-025G	SWP-M-C	T1: 3
09.96 → 08.99	M 96.20		246-086-001-002C	HLWP	T1: 3
2.7 (162 kW 2.7 Liter)					
08.99 → 07.02	M 96.22		246-082-008-025G	SWP-M-C	T1: 3
08.99 → 07.02	M 96.22		246-086-001-002C	HLWP	T1: 3
S 3.2 (185 kW 3.2 Liter)					
08.99 → 07.02	M 96.21		246-082-008-025G	SWP-M-C	T1: 3
08.99 → 07.02	M 96.21		246-086-001-002C	HLWP	T1: 3

RENAULT**CLIO I (B/C57_, 5/357_)**

1.1 (34 kW 1.1 Liter)					
01.91 → 09.98			X10-729-002-006	SWP-M-C	T1: 10; T8



			VDO		
Datum	Motorcode	Fahrgestell Nr.	Artikel Nr.	Artikelbez.	Information

RENAULT**CLIO I (B/C57_, 5/357_)**

1.2 (5/357Y, 5/357K) (40 kW 1.2 Liter)					
01.96 → 09.98	D7F 730		X10-729-002-006	SWP-M-C	T1: 10; T8
1.2 (5/357Y, 5/357K) (43 kW 1.2 Liter)					
01.96 → 09.98	D7F 730		X10-729-002-006	SWP-M-C	T1: 10; T8
1.2 (B/C57R) (40 kW 1.2 Liter)					
01.91 → 01.96	E7F 706		X10-729-002-006	SWP-M-C	T1: 10; T8
1.2 (B/C/S57A, B/C57S, 5/357F, 5/357J, 5/357L, 5/357R) (43 kW 1.2 Liter)					
05.90 → 09.98	E7F 700 / E7F 708 / E7F 750		X10-729-002-006	SWP-M-C	T1: 10; T8
1.2 (B/C/S577) (40 kW 1.2 Liter)					
01.96 → 12.96	C3G 720		X10-729-002-006	SWP-M-C	T1: 10; T8
1.4 (B/C57T, B/C57Y) (58 kW 1.4 Liter)					
01.91 → 09.98	E7J 718 / E7J 719 / E7J 754		X10-729-002-006	SWP-M-C	T1: 10; T8
1.4 (59 kW 1.4 Liter)					
01.91 → 09.98			X10-729-002-006	SWP-M-C	T1: 10; T8
1.7 (B/C574) (68 kW 1.7 Liter)					
01.91 → 12.93	F2N 770		X10-729-002-006	SWP-M-C	T1: 10; T8
1.8 (B/C57C, B/C57U) (65 kW 1.8 Liter)					
01.91 → 09.98	F3P 710 / F3P 714		X10-729-002-006	SWP-M-C	T1: 10; T8
1.8 (B/C578) (66 kW 1.8 Liter)					
08.94 → 09.98	F3P 754 / F3P 755		X10-729-002-006	SWP-M-C	T1: 10; T8
1.8 (70 kW 1.8 Liter)					
01.91 → 09.98			X10-729-002-006	SWP-M-C	T1: 10; T8
1.8 Rsi (B/C57H) (79 kW 1.8 Liter)					
08.95 → 09.98	F3P 758		X10-729-002-006	SWP-M-C	T1: 10; T8
1.8 Rsi (B/C579) (80 kW 1.8 Liter)					
01.93 → 08.95	F3P 712		X10-729-002-006	SWP-M-C	T1: 10; T8
1.8 16V (C57D) (99 kW 1.8 Liter)					
08.91 → 06.94	F7P 722		X10-729-002-006	SWP-M-C	T1: 10; T8
Williams (B/C57M) (108 kW 2.0 Liter)					
01.94 → 09.98	F7R 700		X10-729-002-006	SWP-M-C	T1: 10; T8
1.9 D (40 kW 1.9 Liter)					
01.97 → 09.98			X10-729-002-006	SWP-M-C	T1: 10; T8
1.9 D (B/C/S576, B/C/S57L) (47 kW 1.9 Liter)					
01.91 → 09.98	F8Q 730 / F8Q 732		X10-729-002-006	SWP-M-C	T1: 10; T8

ESPACE II (J/S63_)

2.0 (J636) (76 kW 2.0 Liter)					
01.91 → 10.96	J7R 768		X10-729-002-006	SWP-M-C	T1: 10
2.2 (J/S637, J63G) (79 kW 2.2 Liter)					
01.91 → 10.96	J7T 772 / J7T 773 / J7T 776		X10-729-002-006	SWP-M-C	T1: 10
2.2 4x4 (J/S637, J63G) (79 kW 2.2 Liter)					
03.91 → 12.96	J7T 772 / J7T 773		X10-729-002-006	SWP-M-C	T1: 10



			VDO		
Datum	Motorcode	Fahrgestell Nr.	Artikel Nr.	Artikelbez.	Information

RENAULT**ESPACE II (J/S63_)****2.8 V6 (J638, J63J) (110 kW | 2.8 Liter)**

01.91 → 10.96	Z7W 712 / Z7W 713 / Z7W 717		X10-729-002-006	SWP-M-C	T1: 10
---------------	--------------------------------	--	-----------------	---------	--------

2.1 TD (J633, J634, J/S635, J/S63D) (65 kW | 2.1 Liter)

01.91 → 10.96	J8S 610 / J8S 772 / J8S 776 / J8S 778		X10-729-002-006	SWP-M-C	T1: 10
---------------	------------------------------------------	--	-----------------	---------	--------

2.1 TD (J63E) (66 kW | 2.1 Liter)

11.94 → 10.96	J8S 612		X10-729-002-006	SWP-M-C	T1: 10
---------------	---------	--	-----------------	---------	--------

KANGOO Rapid (FC0/1_)**1.2 (FC01, FC0A, FC0F) (43 kW | 1.2 Liter)**

03.98 →	D7F 710 / D7F 720 / D7F 722 / D7F 726 / D7F 744 / D7F 746		X10-729-002-006	SWP-M-C	T1: 10
---------	-----------------------------------------------------------------	--	-----------------	---------	--------

1.2 16V (FC05) (55 kW | 1.2 Liter)

10.01 →	D4F 712 / D4F 714		X10-729-002-006	SWP-M-C	T1: 10
---------	-------------------	--	-----------------	---------	--------

1.4 (FC0C, FC0B, FC0H, FC0M) (55 kW | 1.4 Liter)

03.98 →	E7J 634 / E7J 635 / E7J 780 / K7J 701		X10-729-002-006	SWP-M-C	T1: 10
---------	------------------------------------------	--	-----------------	---------	--------

1.6 16V (70 kW | 1.6 Liter)

10.01 →	K4M 752		X10-729-002-006	SWP-M-C	T1: 10
---------	---------	--	-----------------	---------	--------

1.6 16V 4x4 (FC0L, FC0P, FC0S) (70 kW | 1.6 Liter)

10.01 →	K4M 750 / K4M 752 / K4M 753		X10-729-002-006	SWP-M-C	T1: 10
---------	--------------------------------	--	-----------------	---------	--------

1.5 dCi (FC07) (48 kW | 1.5 Liter)

12.01 →	K9K 700		X10-729-002-006	SWP-M-C	T1: 10
---------	---------	--	-----------------	---------	--------

D 55 1.9 (FC0D) (40 kW | 1.9 Liter)

03.98 →	F8Q 662		X10-729-002-006	SWP-M-C	T1: 10
---------	---------	--	-----------------	---------	--------

D 65 1.9 (FC0E, FC02, FC0J, FC0N) (47 kW | 1.9 Liter)

03.98 →	F8Q 630 / F8Q 632		X10-729-002-006	SWP-M-C	T1: 10
---------	-------------------	--	-----------------	---------	--------

1.9 dTi (FC0U) (59 kW | 1.9 Liter)

02.00 →	F9Q 780 / F9Q 782		X10-729-002-006	SWP-M-C	T1: 10
---------	-------------------	--	-----------------	---------	--------

1.9 dCi 4x4 (FC0V) (59 kW | 1.9 Liter)

10.01 →	F9Q 782 / F9Q 790		X10-729-002-006	SWP-M-C	T1: 10
---------	-------------------	--	-----------------	---------	--------

MEGANE Classic (LA0/1_)**1.4 (LA0E, LA0V) (55 kW | 1.4 Liter)**

09.96 →	E7J 626 / E7J 764		X10-729-002-006	SWP-M-C	T1: 10; T5: 4
---------	-------------------	--	-----------------	---------	---------------

1.4 16V (LA0D, LA1H, IA0W, LA10) (70 kW | 1.4 Liter)

03.99 →	K4J 714 / K4J 750		X10-729-002-006	SWP-M-C	T1: 10; T5: 4
---------	-------------------	--	-----------------	---------	---------------

1.6 i (LA0L) (55 kW | 1.6 Liter)

09.96 → 03.99	K7M 720		X10-729-002-006	SWP-M-C	T1: 10; T5: 4
---------------	---------	--	-----------------	---------	---------------



			VDO		
Datum	Motorcode	Fahrgestell Nr.	Artikel Nr.	Artikelbez.	Information

RENAULT**MEGANE Classic (LA0/1_)****1.6 e (LA0F, LA0S) (66 kW | 1.6 Liter)**

09.96 → 03.99	K7M 702 / K7M 703 / K7M 790		X10-729-002-006	SWP-M-C	T1: 10; T5: 4
---------------	--------------------------------	--	-----------------	---------	---------------

1.6 16V (La04, LA11, LA0B, LA1C, LA1J) (79 kW | 1.6 Liter)

03.99 →	K4M 700 / K4M 701 / K4M 708		X10-729-002-006	SWP-M-C	T1: 10; T5: 4
---------	--------------------------------	--	-----------------	---------	---------------

1.8 16V (LA06, LA12, LA1A, LA1M, LA1R) (85 kW | 1.8 Liter)

01.01 →	F4P 720 / F4P 722		X10-729-002-006	SWP-M-C	T1: 10; T5: 4
---------	-------------------	--	-----------------	---------	---------------

2.0 i (80 kW | 2.0 Liter)

03.99 →			X10-729-002-006	SWP-M-C	T1: 10; T5: 4
---------	--	--	-----------------	---------	---------------

2.0 i (LA07, LA0G) (84 kW | 2.0 Liter)

09.96 →	F3R 750 / F3R 751		X10-729-002-006	SWP-M-C	T1: 10; T5: 4
---------	-------------------	--	-----------------	---------	---------------

1.9 D (LA0A, LA0U) (47 kW | 1.9 Liter)

09.96 →	F8Q 620 / F8Q 624		X10-729-002-006	SWP-M-C	T1: 10; T5: 4
---------	-------------------	--	-----------------	---------	---------------

1.9 dTi (LA1U) (59 kW | 1.9 Liter)

02.01 →	F9Q 744		X10-729-002-006	SWP-M-C	T1: 10; T5: 4
---------	---------	--	-----------------	---------	---------------

1.9 dT (LA0K, LA0Y) (66 kW | 1.9 Liter)

09.96 →	F8Q 784 / F8Q 786		X10-729-002-006	SWP-M-C	T1: 10; T5: 4
---------	-------------------	--	-----------------	---------	---------------

1.9 TDI (69 kW | 1.9 Liter)

09.96 →			X10-729-002-006	SWP-M-C	T1: 10; T5: 4
---------	--	--	-----------------	---------	---------------

1.9 dTi (LA08, LA0N) (72 kW | 1.9 Liter)

03.97 → 02.01	F9Q 730 / F9Q 731 / F9Q 734 / F9Q 736		X10-729-002-006	SWP-M-C	T1: 10; T5: 4
---------------	------------------------------------------	--	-----------------	---------	---------------

1.9 dCi (LA05, LA1F) (75 kW | 1.9 Liter)

02.01 →	F9Q 732 / F9Q 733		X10-729-002-006	SWP-M-C	T1: 10; T5: 4
---------	-------------------	--	-----------------	---------	---------------

MEGANE Cabriolet (EA0/1_)**1.4 16V (EA0D, EA1H, EA0W, EA10) (70 kW | 1.4 Liter)**

03.99 →	K4J 714 / K4J 750		X10-729-002-006	SWP-M-C	T1: 10
---------	-------------------	--	-----------------	---------	--------

1.6 e (EA0F) (66 kW | 1.6 Liter)

10.96 → 03.99	K7M 702 / K7M 703		X10-729-002-006	SWP-M-C	T1: 10
---------------	-------------------	--	-----------------	---------	--------

1.6 16V (EA0B, EA04, EA11) (79 kW | 1.6 Liter)

03.99 →	K4M 700 / K4M 701 / K4M 708		X10-729-002-006	SWP-M-C	T1: 10
---------	--------------------------------	--	-----------------	---------	--------

2.0 (EA0G) (84 kW | 2.0 Liter)

04.97 →	F3R 750		X10-729-002-006	SWP-M-C	T1: 10
---------	---------	--	-----------------	---------	--------

2.0 i (EA0G) (80 kW | 2.0 Liter)

03.99 →	F3R 791 / F3R 796		X10-729-002-006	SWP-M-C	T1: 10
---------	-------------------	--	-----------------	---------	--------

2.0 16V (102 kW | 2.0 Liter)

01.02 →			X10-729-002-006	SWP-M-C	T1: 10
---------	--	--	-----------------	---------	--------

2.0 16V IDE (EA03, EA0P, EA14) (103 kW | 2.0 Liter)

11.99 →	F5R 740		X10-729-002-006	SWP-M-C	T1: 10
---------	---------	--	-----------------	---------	--------

2.0 16V (EA0H) (108 kW | 2.0 Liter)

10.96 → 11.99	F7R 710 / F7R 714		X10-729-002-006	SWP-M-C	T1: 10
---------------	-------------------	--	-----------------	---------	--------



			VDO		
Datum	Motorcode	Fahrgestell Nr.	Artikel Nr.	Artikelbez.	Information

RENAULT**RAPID Kasten (F40_, G40_)**

1.0 (27 kW 1.0 Liter)					
09.91 → 05.92			X10-729-002-006	SWP-M-C	T1: 10; T6: Transporter
1.1 (F40H) (33 kW 1.1 Liter)					
09.91 → 09.91	C1E 756		X10-729-002-006	SWP-M-C	T1: 10; T6: Transporter
1.1 (F401) (33 kW 1.1 Liter)					
09.91 → 04.95	C1E 750 / C1E 752 / C1E 754 / C1E 760 / C1E 762 / C1E 792		X10-729-002-006	SWP-M-C	T1: 10; T6: Transporter
1.2 (F406, G40A) (40 kW 1.2 Liter)					
09.91 → 03.98	C3G 710 / C3G 712		X10-729-002-006	SWP-M-C	T1: 10; T6: Transporter
1.4 (F407) KAT (43 kW 1.4 Liter)					
09.91 → 03.98	C3J 700 / C3J 702 / C3J 760 / C3J 762		X10-729-002-006	SWP-M-C	T1: 10; T6: Transporter
1.4 (F40U, F40V) (55 kW 1.4 Liter)					
09.91 → 03.98	E7J 720 / E7J 724 / E7J 726 / E7J 773		X10-729-002-006	SWP-M-C	T1: 10; T6: Transporter
1.4 (F40D) (58 kW 1.4 Liter)					
01.94 → 03.98	E7J 728		X10-729-002-006	SWP-M-C	T1: 10; T6: Transporter
1.6 D (F404) (40 kW 1.6 Liter)					
09.91 → 08.98	F8M 720 / F8M 730 / F8M 736 / F8M 760		X10-729-002-006	SWP-M-C	T1: 10; T6: Transporter
1.9 D (F40R) (40 kW 1.9 Liter)					
09.94 → 03.98	F8Q 640 / F8Q 682		X10-729-002-006	SWP-M-C	T1: 10; T6: Transporter
1.9 D (F40P, F40N, F40E) (47 kW 1.9 Liter)					
09.91 → 03.98	F8Q 722 / F8Q 724 / F8Q 774 / F8Q 776		X10-729-002-006	SWP-M-C	T1: 10; T6: Transporter

SAFRANE I (B54_)

2.0 (B540) (77 kW 2.0 Liter)					
11.92 → 07.96	J7R 732 / J7R 733		X10-729-002-006	SWP-M-C	T1: 10
2.0 12V (B542, B54E) (97 kW 2.0 Liter)					
04.92 → 07.96	J7R 734 / J7R 735		X10-729-002-006	SWP-M-C	T1: 10
2.2 (B541) (79 kW 2.2 Liter)					
04.92 → 07.96	J7T 762		X10-729-002-006	SWP-M-C	T1: 10
2.2 (B543) (101 kW 2.2 Liter)					
04.92 → 07.96	J7T 760 / J7T 761		X10-729-002-006	SWP-M-C	T1: 10
3.0 V6 (B54B, B544) (123 kW 3.0 Liter)					
12.92 → 07.96	Z7X 721 / Z7X 722 / Z7X 723		X10-729-002-006	SWP-M-C	T1: 10
3.0 V6 4x4 (B54B, B544) (123 kW 3.0 Liter)					
12.92 → 07.96	Z7X 721 / Z7X 722 / Z7X 723		X10-729-002-006	SWP-M-C	T1: 10
3.0 Biturbo 4x4 (B545) (193 kW 3.0 Liter)					
02.93 → 07.96	Z7X 726		X10-729-002-006	SWP-M-C	T1: 10
2.1 dT (B546) (65 kW 2.1 Liter)					
11.93 → 07.96	J8S 760		X10-729-002-006	SWP-M-C	T1: 10



			VDO		
Datum	Motorcode	Fahrgestell Nr.	Artikel Nr.	Artikelbez.	Information

RENAULT**SAFRANE I (B54_)****2.5 dT (B548) (83 kW | 2.5 Liter)**

12.92 → 07.96	S8U 762 / S8U 763		X10-729-002-006	SWP-M-C	T1: 10
---------------	-------------------	--	-----------------	---------	--------

SAFRANE II (B54_)**2.0 16V (B54L) (100 kW | 2.0 Liter)**

07.96 → 12.00	N7Q 710 / N7Q 711		X10-729-002-006	SWP-M-C	T1: 10
---------------	-------------------	--	-----------------	---------	--------

2.5 20V (B54F) (121 kW | 2.5 Liter)

07.96 → 12.00	N7U 700 / N7U 701		X10-729-002-006	SWP-M-C	T1: 10
---------------	-------------------	--	-----------------	---------	--------

2.9 24V (B54N) (140 kW | 2.9 Liter)

03.99 → 12.00	L7X 713		X10-729-002-006	SWP-M-C	T1: 10
---------------	---------	--	-----------------	---------	--------

3.0 V6 (123 kW | 3.0 Liter)

07.96 → 12.00	Z7X 721 / Z7X 722 / Z7X 723		X10-729-002-006	SWP-M-C	T1: 10
---------------	-----------------------------	--	-----------------	---------	--------

2.2 dT (B54G) (83 kW | 2.2 Liter)

07.96 → 12.00	G8T 740		X10-729-002-006	SWP-M-C	T1: 10
---------------	---------	--	-----------------	---------	--------

19 I (B/C53_)**1.2 (40 kW | 1.2 Liter)**

07.91 → 12.92			X10-729-002-006	SWP-M-C	T1: 10; T8
---------------	--	--	-----------------	---------	------------

1.4 (B/C532) KAT (43 kW | 1.4 Liter)

07.91 → 04.92	C3J 710		X10-729-002-006	SWP-M-C	T1: 10; T8
---------------	---------	--	-----------------	---------	------------

1.4 (59 kW | 1.4 Liter)

07.91 → 12.92	E6J 700 / E6J 701		X10-729-002-006	SWP-M-C	T1: 10; T8
---------------	-------------------	--	-----------------	---------	------------

1.7 (B/C53B) (54 kW | 1.7 Liter)

07.91 → 04.92	F3N 740 / F3N 741		X10-729-002-006	SWP-M-C	T1: 10; T8
---------------	-------------------	--	-----------------	---------	------------

1.7 (B/C53C) (66 kW | 1.7 Liter)

07.91 → 04.92	F3N 742 / F3N 743		X10-729-002-006	SWP-M-C	T1: 10; T8
---------------	-------------------	--	-----------------	---------	------------

1.8 16V (B/C53D) (99 kW | 1.8 Liter)

07.91 → 04.92	F7P 704		X10-729-002-006	SWP-M-C	T1: 10; T8
---------------	---------	--	-----------------	---------	------------

1.9 D (B/C534, B/C53J) (47 kW | 1.9 Liter)

07.91 → 04.92	F8Q 706 / F8Q 742		X10-729-002-006	SWP-M-C	T1: 10; T8
---------------	-------------------	--	-----------------	---------	------------

19 I Chamade (L53_)**1.2 (40 kW | 1.2 Liter)**

07.91 → 12.92			X10-729-002-006	SWP-M-C	T1: 10
---------------	--	--	-----------------	---------	--------

1.4 (L532, L53P) (43 kW | 1.4 Liter)

07.91 → 04.92	C2J 772 / C3J 710		X10-729-002-006	SWP-M-C	T1: 10
---------------	-------------------	--	-----------------	---------	--------

1.7 (L53B) (54 kW | 1.7 Liter)

07.91 → 04.92	F3N 740 / F3N 741		X10-729-002-006	SWP-M-C	T1: 10
---------------	-------------------	--	-----------------	---------	--------

1.7 (L53C) (66 kW | 1.7 Liter)

07.91 → 04.92	F3N 742 / F3N 743		X10-729-002-006	SWP-M-C	T1: 10
---------------	-------------------	--	-----------------	---------	--------

1.8 16V (L53D) (99 kW | 1.8 Liter)

07.91 → 04.92	F7P 704		X10-729-002-006	SWP-M-C	T1: 10
---------------	---------	--	-----------------	---------	--------



			VDO		
Datum	Motorcode	Fahrgestell Nr.	Artikel Nr.	Artikelbez.	Information

RENAULT**19 I Chamade (L53_)****1.9 D (L534, L53J) (47 kW | 1.9 Liter)**

07.91 → 04.92	F8Q 706 / F8Q 742		X10-729-002-006	SWP-M-C	T1: 10
---------------	-------------------	--	-----------------	---------	--------

21 (B48_)**1.7 (B48F) (54 kW | 1.7 Liter)**

04.91 → 10.92	F3N 726		X10-729-002-006	SWP-M-C	T1: 10
---------------	---------	--	-----------------	---------	--------

21 Stufenheck (L48_)**2.0 (78 kW | 2.0 Liter)**

05.91 → 10.93			X10-729-002-006	SWP-M-C	T1: 10
---------------	--	--	-----------------	---------	--------

21 Kombi (K48_)**1.7 (K48F) KAT (54 kW | 1.7 Liter)**

07.91 → 06.93	F3N 726		X10-729-002-006	SWP-M-C	T1: 10
---------------	---------	--	-----------------	---------	--------

1.7 (K/S481) (55 kW | 1.7 Liter)

07.91 → 03.93	F2N 712		X10-729-002-006	SWP-M-C	T1: 10
---------------	---------	--	-----------------	---------	--------

1.9 D (47 kW | 1.9 Liter)

07.91 → 08.94			X10-729-002-006	SWP-M-C	T1: 10
---------------	--	--	-----------------	---------	--------

SAAB**90****2.0 (74 kW | 2.0 Liter)**

08.84 → 12.85	B 20 I	E600792 →	246-082-008-014C	SWP-M-C	T1: 1
---------------	--------	-----------	------------------	---------	-------

900 I Combi Coupe**2.0 c (74 kW | 2.0 Liter)**

09.83 → 12.88	B 20 / B201XC		246-082-001-001C	SWP-M-C	T1: 2
---------------	---------------	--	------------------	---------	-------

10.80 → 12.83	B 20 / B201XC		246-082-008-014C	SWP-M-C	T1: 1
---------------	---------------	--	------------------	---------	-------

2.0 c (79 kW | 2.0 Liter)

09.83 → 08.84	B20T / BT 20		246-082-001-001C	SWP-M-C	T1: 2
---------------	--------------	--	------------------	---------	-------

2.0 i (81 kW | 2.0 Liter)

09.85 → 12.89	B201		246-082-001-001C	SWP-M-C	T1: 2
---------------	------	--	------------------	---------	-------

2.0 -16 (93 kW | 2.0 Liter)

01.89 → 08.92	B202I		246-082-001-001C	SWP-M-C	T1: 2
---------------	-------	--	------------------	---------	-------

2.0 S Turbo-16 (104 kW | 2.0 Liter)

09.91 → 06.93	B202S		246-082-001-001C	SWP-M-C	T1: 2
---------------	-------	--	------------------	---------	-------



			VDO		
Datum	Motorcode	Fahrgestell Nr.	Artikel Nr.	Artikelbez.	Information

SAAB**900 I Combi Coupe****2.0 Turbo (107 kW | 2.0 Liter)**

09.83 → 07.85	B201S / BSI 20		246-082-001-001C	SWP-M-C	T1: 2
10.80 → 12.83	B201S / BSI 20		246-082-008-014C	SWP-M-C	T1: 1

2.0 Turbo-16 (118 kW | 2.0 Liter)

11.85 → 06.93	B202XL		246-082-001-001C	SWP-M-C	T1: 2
---------------	--------	--	------------------	---------	-------

2.0 Turbo-16 S (129 kW | 2.0 Liter)

02.84 → 12.88	B202XL		246-082-001-001C	SWP-M-C	T1: 2
---------------	--------	--	------------------	---------	-------

2.0 Turbo-16 S KAT (125 kW | 2.0 Liter)

01.89 → 06.93	B202XL		246-082-001-001C	SWP-M-C	T1: 2
---------------	--------	--	------------------	---------	-------

900 I**2.0 c (79 kW | 2.0 Liter)**

09.83 → 08.84	B20T / BT 20		246-082-001-001C	SWP-M-C	T1: 2
11.80 → 12.83	B20T / BT 20		246-082-008-014C	SWP-M-C	T1: 1

2.0 -16 (93 kW | 2.0 Liter)

01.89 → 06.93	B202I		246-082-001-001C	SWP-M-C	T1: 2
---------------	-------	--	------------------	---------	-------

2.0 Turbo (107 kW | 2.0 Liter)

09.83 → 07.85	B201S / BSI 20		246-082-001-001C	SWP-M-C	T1: 2
10.81 → 12.83	B201S / BSI 20		246-082-008-014C	SWP-M-C	T1: 1

2.0 S Turbo-16 (107 kW | 2.0 Liter)

01.92 → 06.93	B202S		246-082-001-001C	SWP-M-C	T1: 2
---------------	-------	--	------------------	---------	-------

2.0 Turbo-16 S (129 kW | 2.0 Liter)

01.84 → 12.88	B202XL		246-082-001-001C	SWP-M-C	T1: 2
---------------	--------	--	------------------	---------	-------

900 I Cabriolet**2.0 -16 (93 kW | 2.0 Liter)**

01.90 → 06.93	B202I		246-082-001-001C	SWP-M-C	T1: 2
---------------	-------	--	------------------	---------	-------

2.0 S Turbo-16 (104 kW | 2.0 Liter)

09.91 → 06.93	B202S		246-082-001-001C	SWP-M-C	T1: 2
---------------	-------	--	------------------	---------	-------

2.0 Turbo-16 (118 kW | 2.0 Liter)

11.86 → 06.93	B202XL		246-082-001-001C	SWP-M-C	T1: 2
---------------	--------	--	------------------	---------	-------

2.0 Turbo-16 S (129 kW | 2.0 Liter)

01.89 → 06.93	B202XL		246-082-001-001C	SWP-M-C	T1: 2
---------------	--------	--	------------------	---------	-------

9000 Schrägheck**2.0 -16 (92 kW | 2.0 Liter)**

03.86 → 12.88	B202XI (KAT)		246-082-001-001C	SWP-M-C	T1: 2
---------------	--------------	--	------------------	---------	-------

2.0 -16 Turbo (118 kW | 2.0 Liter)

09.84 → 07.89	B202XL		246-082-001-001C	SWP-M-C	T1: 2
---------------	--------	--	------------------	---------	-------

2.0 -16 Turbo (120 kW | 2.0 Liter)

05.88 → 12.91	B202XL		246-082-001-001C	SWP-M-C	T1: 2
---------------	--------	--	------------------	---------	-------



			VDO		
Datum	Motorcode	Fahrgestell Nr.	Artikel Nr.	Artikelbez.	Information

SAAB**9000 Schrägheck****2.3 -16 CS (107 kW | 2.3 Liter)**

08.90 → 12.91	B234I		246-082-001-001C	SWP-M-C	T1: 2
---------------	-------	--	------------------	---------	-------

2.3 -16 Turbo (143 kW | 2.3 Liter)

07.91 → 12.91	B234L		246-082-001-001C	SWP-M-C	T1: 2
---------------	-------	--	------------------	---------	-------

9000**2.0 -16 (94 kW | 2.0 Liter)**

08.90 → 12.91	B202I		246-082-001-001C	SWP-M-C	T1: 2
---------------	-------	--	------------------	---------	-------

2.3 -16 CD (107 kW | 2.3 Liter)

01.90 → 12.91	B234I		246-082-001-001C	SWP-M-C	T1: 2
---------------	-------	--	------------------	---------	-------

2.3 -16 Turbo (143 kW | 2.3 Liter)

09.90 → 12.91	B234L		246-082-001-001C	SWP-M-C	T1: 2
---------------	-------	--	------------------	---------	-------

SEAT**ALHAMBRA (7V8, 7V9)****1.8 T 20V (110 kW | 1.8 Liter)**

05.98 →	AJH / AWC		246-083-002-014G	SWP-D-C	T1: 6
---------	-----------	--	------------------	---------	-------

06.00 →	AJH / AWC	- 1 - 500 001 →	246-083-002-022G	SWP-D-C	T1: 3
---------	-----------	-----------------	------------------	---------	-------

10.97 →	AJH / AWC		246-086-001-002C	HLWP	T1: 3
---------	-----------	--	------------------	------	-------

2.0 i (85 kW | 2.0 Liter)

04.96 →	ADY / ATM		246-083-002-014G	SWP-D-C	T1: 6
---------	-----------	--	------------------	---------	-------

06.00 →	ADY / ATM	- 1 - 500 001 →	246-083-002-022G	SWP-D-C	T1: 3
---------	-----------	-----------------	------------------	---------	-------

04.96 →	ADY / ATM		246-086-001-002C	HLWP	T1: 3
---------	-----------	--	------------------	------	-------

2.8 V6 (150 kW | 2.8 Liter)

06.00 →	AYL		246-083-002-022G	SWP-D-C	T1: 3
---------	-----	--	------------------	---------	-------

06.00 →	AYL		246-086-001-002C	HLWP	T1: 3
---------	-----	--	------------------	------	-------

2.8 V6 4motion (150 kW | 2.8 Liter)

02.01 →	AYL		246-083-002-022G	SWP-D-C	T1: 3
---------	-----	--	------------------	---------	-------

02.01 →	AYL		246-086-001-002C	HLWP	T1: 3
---------	-----	--	------------------	------	-------

1.9 TDI (66 kW | 1.9 Liter)

04.96 → 06.96	1Z / AHU / ANU		246-083-002-014G	SWP-D-C	T1: 6
---------------	----------------	--	------------------	---------	-------

06.00 →	1Z / AHU / ANU	- 1 - 500 001 →	246-083-002-022G	SWP-D-C	T1: 3
---------	----------------	-----------------	------------------	---------	-------

04.96 →	1Z / AHU / ANU		246-086-001-002C	HLWP	T1: 3
---------	----------------	--	------------------	------	-------

1.9 TDI (81 kW | 1.9 Liter)

06.00 → 06.00	AFN	- 1 - 500 001 →	246-083-002-022G	SWP-D-C	T1: 3
---------------	-----	-----------------	------------------	---------	-------

08.96 → 06.00	AFN		246-086-001-002C	HLWP	T1: 3
---------------	-----	--	------------------	------	-------

1.9 TDI (85 kW | 1.9 Liter)

06.00 →	AUY		246-083-002-022G	SWP-D-C	T1: 3
---------	-----	--	------------------	---------	-------

06.00 →	AUY		246-086-001-002C	HLWP	T1: 3
---------	-----	--	------------------	------	-------



			VDO		
Datum	Motorcode	Fahrgestell Nr.	Artikel Nr.	Artikelbez.	Information

SEAT**ALHAMBRA (7V8, 7V9)****1.9 TDI 4motion (85 kW | 1.9 Liter)**

02.01 →	AUY	- 1 - 500 001 →	246-083-002-022G	SWP-D-C	T1: 3
02.01 →	AUY		246-086-001-002C	HLWP	T1: 3

1.9 TDI (96 kW | 1.9 Liter)

11.02 →	ASZ		246-083-002-022G	SWP-D-C	T1: 3
11.02 →	ASZ		246-086-001-007C	HLWP	T1: 3b

1.9 TDI (110 kW | 1.9 Liter)

05.05 →			246-083-002-022G	SWP-D-C	T1: 3
05.05 →			246-086-001-007C	HLWP	T1: 3b

ALTEA (5P1)**1.6 (75 kW | 1.6 Liter)**

03.04 →	BGU / BSE / BSF		246-083-002-022G	SWP-D-C	T1: 3
03.04 →	BGU / BSE / BSF		246-086-001-007C	HLWP	T1: 3b

2.0 FSI (110 kW | 2.0 Liter)

05.04 →	BLR / BLY		246-083-002-022G	SWP-D-C	T1: 3
05.04 →	BLR / BLY		246-086-001-007C	HLWP	T1: 3b

1.9 TDI (77 kW | 1.9 Liter)

04.04 →	BJB / BKC		246-083-002-022G	SWP-D-C	T1: 3
04.04 →	BJB / BKC		246-086-001-007C	HLWP	T1: 3b

2.0 TDI (100 kW | 2.0 Liter)

03.04 →	AZV		246-083-002-022G	SWP-D-C	T1: 3
03.04 →	AZV		246-086-001-007C	HLWP	T1: 3b

2.0 TDI (103 kW | 2.0 Liter)

03.04 →	BKD		246-083-002-022G	SWP-D-C	T1: 3
03.04 →	BKD		246-086-001-007C	HLWP	T1: 3b

AROSA (6H)**1.0 (37 kW | 1.0 Liter)**

05.97 → 09.99	AER / AHT / ALD / ALL / ANV / AUC		246-083-002-022G	SWP-D-C	T1: 3
---------------	-----------------------------------	--	------------------	---------	-------

1.4 (44 kW | 1.4 Liter)

05.97 → 04.98	AEX / AKK / AKV / ANW / APQ / AUD		246-083-002-022G	SWP-D-C	T1: 3
---------------	-----------------------------------	--	------------------	---------	-------

1.4 16V (74 kW | 1.4 Liter)

01.00 →	AFK / ANM / AQQ / AUB		246-083-002-022G	SWP-D-C	T1: 3
---------	-----------------------	--	------------------	---------	-------

1.4 TDI (55 kW | 1.4 Liter)

01.00 →	AMF		246-083-002-022G	SWP-D-C	T1: 3
---------	-----	--	------------------	---------	-------

1.7 SDI (44 kW | 1.7 Liter)

08.97 → 01.99	AKU		246-083-002-022G	SWP-D-C	T1: 3
---------------	-----	--	------------------	---------	-------



			VDO		
Datum	Motorcode	Fahrgestell Nr.	Artikel Nr.	Artikelbez.	Information

SEAT**CORDOBA (6K2/C2)****1.0 i (37 kW | 1.0 Liter)**

09.96 → 06.99	AER		246-069-056-001Z	N	
09.96 → 06.99	AER		246-080-010-002Z	N-H	T7: CLX →>
06.97 → 04.99	AER		246-082-008-021G	SWP-M-C	T1: 6
09.96 → 06.99	AER		246-086-001-002C	HLWP	T1: 3; T7: CLX →>

1.4 i (44 kW | 1.4 Liter)

06.94 → 06.99	ABD / AEX / AKV / ANX / APQ		246-069-056-001Z	N	
06.94 → 06.99	ABD / AEX / AKV / ANX / APQ		246-080-010-002Z	N-H	T7: CLX →>
06.94 → 12.97	ABD / AEX / AKV / ANX / APQ		246-082-008-021G	SWP-M-C	T1: 6
06.94 → 06.99	ABD / AEX / AKV / ANX / APQ		246-086-001-002C	HLWP	T1: 3; T7: CLX →>

1.4 i 16V (74 kW | 1.4 Liter)

09.96 → 06.99	AFH		246-069-056-001Z	N	
09.96 → 06.99	AFH		246-080-010-002Z	N-H	T7: CLX →>
06.97 → 04.99	AFH		246-082-008-021G	SWP-M-C	T1: 6
09.96 → 06.99	AFH		246-086-001-002C	HLWP	T1: 3; T7: CLX →>

1.6 i (55 kW | 1.6 Liter)

05.94 → 06.99	1F		246-082-008-021G	SWP-M-C	T1: 6
05.94 → 06.99	1F		246-086-001-007C	HLWP	T1: 3b

1.6 i (55 kW | 1.6 Liter)

02.93 → 06.99	ABU / AEE / ALM		246-069-056-001Z	N	
02.93 → 06.99	ABU / AEE / ALM		246-080-010-002Z	N-H	T7: CLX →>
11.93 → 04.99	ABU / AEE / ALM		246-082-008-021G	SWP-M-C	T1: 6
02.93 → 06.99	ABU / AEE / ALM		246-086-001-002C	HLWP	T1: 3; T7: CLX →>

1.6 i (74 kW | 1.6 Liter)

07.96 → 06.99	AFT		246-069-056-001Z	N	
07.96 → 06.99	AFT		246-080-010-002Z	N-H	T7: CLX →>
07.96 → 05.98	AFT		246-082-008-021G	SWP-M-C	T1: 6
07.96 → 06.99	AFT		246-086-001-002C	HLWP	T1: 3; T7: CLX →>

1.8 i (66 kW | 1.8 Liter)

02.93 → 06.99	ABS / ADZ		246-069-056-001Z	N	
02.93 → 06.99	ABS / ADZ		246-080-010-002Z	N-H	T7: CLX →>
11.93 → 04.99	ABS / ADZ		246-082-008-021G	SWP-M-C	T1: 6
02.93 → 06.99	ABS / ADZ		246-086-001-002C	HLWP	T1: 3; T7: CLX →>

1.8 i 16V (95 kW | 1.8 Liter)

10.93 → 08.96	ADL		246-069-056-001Z	N	
10.93 → 08.96	ADL		246-080-010-002Z	N-H	T7: CLX →>
03.94 → 06.96	ADL		246-082-008-021G	SWP-M-C	T1: 6
10.93 → 08.96	ADL		246-086-001-002C	HLWP	T1: 3; T7: CLX →>

2.0 i (85 kW | 2.0 Liter)

02.93 → 06.99	2E / AGG		246-069-056-001Z	N	
02.93 → 06.99	2E / AGG		246-080-010-002Z	N-H	T7: CLX →>
11.93 → 04.99	2E / AGG		246-082-008-021G	SWP-M-C	T1: 6
02.93 → 06.99	2E / AGG		246-086-001-002C	HLWP	T1: 3; T7: CLX →>



			VDO		
Datum	Motorcode	Fahrgestell Nr.	Artikel Nr.	Artikelbez.	Information

SEAT**CORDOBA (6K2/C2)****2.0 i 16V (110 kW | 2.0 Liter)**

08.96 → 06.99	ABF		246-069-056-001Z	N	
08.96 → 06.99	ABF		246-080-010-002Z	N-H	T7: CLX →
08.96 → 04.99	ABF		246-082-008-021G	SWP-M-C	T1: 6
08.96 → 06.99	ABF		246-086-001-002C	HLWP	T1: 3; T7: CLX →

1.7 SDI (44 kW | 1.7 Liter)

07.97 → 06.99			246-069-056-001Z	N	
07.97 → 06.99			246-080-010-002Z	N-H	T7: CLX →
07.97 → 06.99			246-086-001-002C	HLWP	T1: 3; T7: CLX →

1.9 D (47 kW | 1.9 Liter)

01.96 → 08.96	1Y		246-069-056-001Z	N	
01.96 → 08.96	1Y		246-080-010-002Z	N-H	T7: CLX →
01.96 → 06.96	1Y		246-082-008-021G	SWP-M-C	T1: 6
01.96 → 08.96	1Y		246-086-001-002C	HLWP	T1: 3; T7: CLX →

1.9 SDI (47 kW | 1.9 Liter)

08.96 → 06.99	AEY		246-069-056-001Z	N	
08.96 → 06.99	AEY		246-080-010-002Z	N-H	T7: CLX →
08.96 → 06.99	AEY		246-086-001-002C	HLWP	T1: 3; T7: CLX →

1.9 D (50 kW | 1.9 Liter)

02.93 → 08.96	1Y		246-069-056-001Z	N	
02.93 → 08.96	1Y		246-080-010-002Z	N-H	T7: CLX →
11.93 → 07.94	1Y		246-082-008-021G	SWP-M-C	T1: 6
02.93 → 08.96	1Y		246-086-001-002C	HLWP	T1: 3; T7: CLX →

1.9 TD (55 kW | 1.9 Liter)

02.93 → 08.96	AAZ		246-069-056-001Z	N	
02.93 → 08.96	AAZ		246-080-010-002Z	N-H	T7: CLX →
11.93 → 06.96	AAZ		246-082-008-021G	SWP-M-C	T1: 6
02.93 → 08.96	AAZ		246-086-001-002C	HLWP	T1: 3; T7: CLX →

1.9 TDI (66 kW | 1.9 Liter)

08.96 → 06.99	1Z / AHU		246-069-056-001Z	N	
08.96 → 06.99	1Z / AHU		246-080-010-002Z	N-H	T7: CLX →
08.96 → 06.99	1Z / AHU		246-086-001-002C	HLWP	T1: 3; T7: CLX →

1.9 TDI (81 kW | 1.9 Liter)

03.97 → 06.99	AFN		246-069-056-001Z	N	
03.97 → 06.99	AFN		246-080-010-002Z	N-H	T7: CLX →
03.97 → 06.99	AFN		246-086-001-002C	HLWP	T1: 3; T7: CLX →

CORDOBA Vario (6K5)**1.4 i (44 kW | 1.4 Liter)**

09.96 → 06.99	AEX / AKV / ANX / APQ		246-069-056-001Z	N	
05.97 → 11.97	AEX / AKV / ANX / APQ		246-082-008-021G	SWP-M-C	T1: 6



			VDO		
Datum	Motorcode	Fahrgestell Nr.	Artikel Nr.	Artikelbez.	Information

SEAT**CORDOBA Vario (6K5)****1.6 i (55 kW | 1.6 Liter)**

05.97 → 06.99	1F	6K-X-400 000 →; → 6K-X-499 999	246-082-008-025G	SWP-M-C	T1: 3
05.97 → 06.99	1F		246-083-002-022G	SWP-D-C	T1: 3
05.97 → 06.99	1F	6K-X-400 000 →; → 6K-X-499 999	246-086-001-007C	HLWP	T1: 3b

1.6 i (55 kW | 1.6 Liter)

09.96 → 06.99	AEE / ALM		246-069-056-001Z	N	
05.97 → 05.99	AEE / ALM		246-082-008-021G	SWP-M-C	T1: 6

1.6 i (74 kW | 1.6 Liter)

09.96 → 06.99	AFT		246-069-056-001Z	N	
04.97 → 05.98	AFT		246-082-008-021G	SWP-M-C	T1: 6

1.7 SDI (44 kW | 1.7 Liter)

07.97 → 06.99			246-069-056-001Z	N	
---------------	--	--	------------------	---	--

1.9 SDI (47 kW | 1.9 Liter)

09.96 → 06.99	AEY		246-069-056-001Z	N	
---------------	-----	--	------------------	---	--

1.9 TDI (66 kW | 1.9 Liter)

08.96 → 06.99	1Z / AHU		246-069-056-001Z	N	
---------------	----------	--	------------------	---	--

1.9 TDI (81 kW | 1.9 Liter)

07.97 → 06.99	AFN		246-069-056-001Z	N	
---------------	-----	--	------------------	---	--

CORDOBA (6K2)**1.0 (37 kW | 1.0 Liter)**

06.99 → 10.02	ALD / ANV / AUC	6K-X-400 000 →; → 6K-X-499 999	246-083-002-022G	SWP-D-C	T1: 3
06.99 → 10.02	ALD / ANV / AUC	6K-X-400 000 →; → 6K-X-499 999	246-086-001-007C	HLWP	T1: 3b

1.0 16V (51 kW | 1.0 Liter)

05.00 → 10.02	AST / AVZ	6K-X-400 000 →; → 6K-X-499 999	246-083-002-022G	SWP-D-C	T1: 3
05.00 → 10.02	AST / AVZ	6K-X-400 000 →; → 6K-X-499 999	246-086-001-007C	HLWP	T1: 3b

1.4 (44 kW | 1.4 Liter)

06.99 → 10.02	AKK / ANW / AUD		246-083-002-022G	SWP-D-C	T1: 3; T7: Stella →
06.99 → 10.02	AKK / ANW / AUD		246-086-001-002C	HLWP	T1: 3; T7: Stella →

1.4 16V (55 kW | 1.4 Liter)

05.00 → 10.02	APE / AUA		246-083-002-022G	SWP-D-C	T1: 3; T7: Stella →
05.00 → 10.02	APE / AUA		246-086-001-002C	HLWP	T1: 3; T7: Stella →

1.4 16V (74 kW | 1.4 Liter)

02.00 → 10.02	AQQ / AUB	6K-X-400 000 →; → 6K-X-499 999	246-083-002-022G	SWP-D-C	T1: 3
02.00 → 10.02	AQQ / AUB	6K-X-400 000 →; → 6K-X-499 999	246-086-001-007C	HLWP	T1: 3b



			VDO		
Datum	Motorcode	Fahrgestell Nr.	Artikel Nr.	Artikelbez.	Information

SEAT**CORDOBA (6K2)****1.6 (55 kW | 1.6 Liter)**

06.99 → 10.02	ALM		246-083-002-022G	SWP-D-C	T1: 3; T7: Stella →
06.99 → 10.02	ALM		246-086-001-002C	HLWP	T1: 3; T7: Stella →

1.6 (74 kW | 1.6 Liter)

06.99 → 10.02	AEH / AKL / APF / AUR		246-083-002-022G	SWP-D-C	T1: 3; T7: Stella →
06.99 → 10.02	AEH / AKL / APF / AUR		246-086-001-002C	HLWP	T1: 3; T7: Stella →

1.8 T 20V Cupra (115 kW | 1.8 Liter)

07.00 → 10.02	AQX		246-083-002-022G	SWP-D-C	T1: 3; T7: Stella →
07.00 → 10.02	AQX		246-086-001-002C	HLWP	T1: 3; T7: Stella →

1.9 SDI (50 kW | 1.9 Liter)

06.99 → 10.02	AGP / AQM		246-083-002-022G	SWP-D-C	T1: 3; T7: Stella →
06.99 → 10.02	AGP / AQM		246-086-001-002C	HLWP	T1: 3; T7: Stella →

1.9 TDI (66 kW | 1.9 Liter)

06.99 → 10.02	AGR / ALH		246-083-002-022G	SWP-D-C	T1: 3; T7: Stella →
06.99 → 10.02	AGR / ALH		246-086-001-002C	HLWP	T1: 3; T7: Stella →

1.9 TDI (81 kW | 1.9 Liter)

06.99 → 10.02	ASK / ASV		246-083-002-022G	SWP-D-C	T1: 3; T7: Stella →
06.99 → 10.02	ASK / ASV		246-086-001-002C	HLWP	T1: 3; T7: Stella →

CORDOBA Vario (6K5)**1.4 (44 kW | 1.4 Liter)**

06.99 →	AKK / ANW / AUD	6K-X-400 000 →; → 6K-X-499 999	246-082-008-025G	SWP-M-C	T1: 3
06.99 →	AKK / ANW / AUD		246-083-002-022G	SWP-D-C	T1: 3
06.99 →	AKK / ANW / AUD	6K-X-400 000 →; → 6K-X-499 999	246-086-001-007C	HLWP	T1: 3b

1.4 16V (55 kW | 1.4 Liter)

06.99 →	APE	6K-X-400 000 →; → 6K-X-499 999	246-082-008-025G	SWP-M-C	T1: 3
06.99 →	APE		246-083-002-022G	SWP-D-C	T1: 3
06.99 →	APE	6K-X-400 000 →; → 6K-X-499 999	246-086-001-007C	HLWP	T1: 3b

1.6 (55 kW | 1.6 Liter)

06.99 →	ALM	6K-X-400 000 →; → 6K-X-499 999	246-082-008-025G	SWP-M-C	T1: 3
06.99 →	ALM		246-083-002-022G	SWP-D-C	T1: 3
06.99 →	ALM	6K-X-400 000 →; → 6K-X-499 999	246-086-001-007C	HLWP	T1: 3b

1.6 (74 kW | 1.6 Liter)

06.99 →	AEH / AKL / APF / AUR	6K-X-400 000 →; → 6K-X-499 999	246-082-008-025G	SWP-M-C	T1: 3
06.99 →	AEH / AKL / APF / AUR		246-083-002-022G	SWP-D-C	T1: 3
06.99 →	AEH / AKL / APF / AUR	6K-X-400 000 →; → 6K-X-499 999	246-086-001-007C	HLWP	T1: 3b



			VDO		
Datum	Motorcode	Fahrgestell Nr.	Artikel Nr.	Artikelbez.	Information

SEAT**CORDOBA Vario (6K5)****1.9 SDI (50 kW | 1.9 Liter)**

06.99 →	AGP / AQM	6K-X-400 000 →; → 6K-X-499 999	246-082-008-025G	SWP-M-C	T1: 3
06.99 →	AGP / AQM		246-083-002-022G	SWP-D-C	T1: 3
06.99 →	AGP / AQM	6K-X-400 000 →; → 6K-X-499 999	246-086-001-007C	HLWP	T1: 3b

1.9 TDI (66 kW | 1.9 Liter)

06.99 →	AGR / ALH	6K-X-400 000 →; → 6K-X-499 999	246-082-008-025G	SWP-M-C	T1: 3
06.99 →	AGR / ALH		246-083-002-022G	SWP-D-C	T1: 3
06.99 →	AGR / ALH	6K-X-400 000 →; → 6K-X-499 999	246-086-001-007C	HLWP	T1: 3b

1.9 TDI (81 kW | 1.9 Liter)

06.99 →	ASK / ASV	6K-X-400 000 →; → 6K-X-499 999	246-082-008-025G	SWP-M-C	T1: 3
06.99 →	ASK / ASV		246-083-002-022G	SWP-D-C	T1: 3
06.99 →	ASK / ASV	6K-X-400 000 →; → 6K-X-499 999	246-086-001-007C	HLWP	T1: 3b

CORDOBA (6L2)**1.2 (47 kW | 1.2 Liter)**

10.02 →	AZQ		246-082-008-025G	SWP-M-C	T1: 3
10.02 →	AZQ		246-083-002-022G	SWP-D-C	T1: 3
10.02 →	AZQ		246-086-001-007C	HLWP	T1: 3b

1.4 16V (55 kW | 1.4 Liter)

09.02 →	BBY		246-082-008-025G	SWP-M-C	T1: 3
09.02 →	BBY		246-083-002-022G	SWP-D-C	T1: 3
09.02 →	BBY		246-086-001-007C	HLWP	T1: 3b

1.4 16V (74 kW | 1.4 Liter)

10.02 →	BBZ		246-082-008-025G	SWP-M-C	T1: 3
10.02 →	BBZ		246-083-002-022G	SWP-D-C	T1: 3
10.02 →	BBZ		246-086-001-007C	HLWP	T1: 3b

1.6 (74 kW | 1.6 Liter)

04.03 →	BAH		246-082-008-025G	SWP-M-C	T1: 3
04.03 →	BAH		246-083-002-022G	SWP-D-C	T1: 3
04.03 →	BAH		246-086-001-007C	HLWP	T1: 3b

2.0 (85 kW | 2.0 Liter)

09.02 →	AZL / BBX		246-082-008-025G	SWP-M-C	T1: 3
09.02 →	AZL / BBX		246-083-002-022G	SWP-D-C	T1: 3
09.02 →	AZL / BBX		246-086-001-007C	HLWP	T1: 3b

1.4 TDI (55 kW | 1.4 Liter)

10.02 →	AMF		246-082-008-025G	SWP-M-C	T1: 3
10.02 →	AMF		246-083-002-022G	SWP-D-C	T1: 3
10.02 →	AMF		246-086-001-007C	HLWP	T1: 3b



			VDO		
Datum	Motorcode	Fahrgestell Nr.	Artikel Nr.	Artikelbez.	Information

SEAT**CORDOBA (6L2)****1.9 SDI (47 kW | 1.9 Liter)**

09.02 →	ASY		246-082-008-025G	SWP-M-C	T1: 3
09.02 →	ASY		246-083-002-022G	SWP-D-C	T1: 3
09.02 →	ASY		246-086-001-007C	HLWP	T1: 3b

1.9 TDI (74 kW | 1.9 Liter)

09.02 →	ATD		246-082-008-025G	SWP-M-C	T1: 3
09.02 →	ATD		246-083-002-022G	SWP-D-C	T1: 3
09.02 →	ATD		246-086-001-007C	HLWP	T1: 3b

1.9 TDI (96 kW | 1.9 Liter)

10.02 →	ASZ		246-082-008-025G	SWP-M-C	T1: 3
10.02 →	ASZ		246-083-002-022G	SWP-D-C	T1: 3
10.02 →	ASZ		246-086-001-007C	HLWP	T1: 3b

IBIZA II (6K1)**1.0 i (37 kW | 1.0 Liter)**

09.96 → 08.99	AER	6K - VR 000 001 →	246-069-056-001Z	N	
09.96 → 08.99	AER		246-080-010-002Z	N-H	T7: CL →→
09.96 → 08.99	AER		246-083-002-014G	SWP-D-C	T1: 6
09.96 → 08.99	AER		246-086-001-002C	HLWP	T1: 3; T7: CL →→

1.0 (33 kW | 1.0 Liter)

09.96 → 09.96	AAU	6K - VR 000 001 →	246-069-056-001Z	N	
03.93 → 09.96	AAU		246-080-010-002Z	N-H	T7: CL →→
03.93 → 06.96	AAU		246-083-002-014G	SWP-D-C	T1: 6
03.93 → 09.96	AAU		246-086-001-002C	HLWP	T1: 3; T7: CL →→

1.3 i (40 kW | 1.3 Liter)

09.96 → 08.99	AAV	6K - VR 000 001 →	246-069-056-001Z	N	
03.93 → 08.99	AAV		246-080-010-002Z	N-H	T7: CL →→
03.93 → 07.94	AAV		246-083-002-014G	SWP-D-C	T1: 6
03.93 → 08.99	AAV		246-086-001-002C	HLWP	T1: 3; T7: CL →→

1.4 i (44 kW | 1.4 Liter)

09.96 → 08.99	ABD / AEX / AKV / APQ	6K - VR 000 001 →	246-069-056-001Z	N	
09.93 → 08.99	ABD / AEX / AKV / APQ		246-080-010-002Z	N-H	T7: CL →→
09.93 → 12.97	ABD / AEX / AKV / APQ		246-083-002-014G	SWP-D-C	T1: 6
09.93 → 08.99	ABD / AEX / AKV / APQ		246-086-001-002C	HLWP	T1: 3; T7: CL →→





1.4 i 16V (74 kW | 1.4 Liter)

09.96 → 08.99	AFH	6K - VR 000 001 →	246-069-056-001Z	N	
09.96 → 08.99	AFH		246-080-010-002Z	N-H	T7: CL →→
06.97 → 08.99	AFH		246-083-002-014G	SWP-D-C	T1: 6
09.96 → 08.99	AFH		246-086-001-002C	HLWP	T1: 3; T7: CL →→

1.6 i (55 kW | 1.6 Liter)

09.94 → 06.99	1F		246-082-008-021G	SWP-M-C	T1: 6
09.94 → 06.99	1F		246-086-001-007C	HLWP	T1: 3b



			VDO		
Datum	Motorcode	Fahrgestell Nr.	Artikel Nr.	Artikelbez.	Information

SEAT**IBIZA II (6K1)**

1.6 i (74 kW 1.6 Liter)					
09.96 → 08.99	AFT	6K - VR 000 001 →	246-069-056-001Z	N	
04.96 → 08.99	AFT		246-080-010-002Z	N-H	T7: CL →>
07.96 → 05.98	AFT		246-083-002-014G	SWP-D-C	T1: 6
04.96 → 08.99	AFT		246-086-001-002C	HLWP	T1: 3; T7: CL →>
1.6 i (55 kW 1.6 Liter)					
09.96 → 08.99	ABU / AEE / ALM	6K - VR 000 001 →	246-069-056-001Z	N	
03.93 → 08.99	ABU / AEE / ALM		246-080-010-002Z	N-H	T7: CL →>
03.93 → 12.98	ABU / AEE / ALM		246-083-002-014G	SWP-D-C	T1: 6
03.93 → 08.99	ABU / AEE / ALM		246-086-001-002C	HLWP	T1: 3; T7: CL →>
1.8 i (66 kW 1.8 Liter)					
09.96 → 08.99	ABS / ADZ	6K - VR 000 001 →	246-069-056-001Z	N	
03.93 → 08.99	ABS / ADZ		246-080-010-002Z	N-H	T7: CL →>
03.93 → 06.96	ABS / ADZ		246-083-002-014G	SWP-D-C	T1: 6
03.93 → 08.99	ABS / ADZ		246-086-001-002C	HLWP	T1: 3; T7: CL →>
1.8 i 16V (95 kW 1.8 Liter)					
11.93 → 08.96	ADL		246-080-010-002Z	N-H	T7: CL →>
02.94 → 06.96	ADL		246-083-002-014G	SWP-D-C	T1: 6
11.93 → 08.96	ADL		246-086-001-002C	HLWP	T1: 3; T7: CL →>
2.0 i (85 kW 2.0 Liter)					
09.96 → 08.99	2E / AGG	6K - VR 000 001 →	246-069-056-001Z	N	
03.93 → 08.99	2E / AGG		246-080-010-002Z	N-H	T7: CL →>
03.93 → 06.96	2E / AGG		246-083-002-014G	SWP-D-C	T1: 6
03.93 → 08.99	2E / AGG		246-086-001-002C	HLWP	T1: 3; T7: CL →>
2.0 i 16V (110 kW 2.0 Liter)					
09.96 → 08.99	ABF	6K - VR 000 001 →	246-069-056-001Z	N	
08.96 → 08.99	ABF		246-080-010-002Z	N-H	T7: CL →>
08.96 → 08.99	ABF		246-083-002-014G	SWP-D-C	T1: 6
08.96 → 08.99	ABF		246-086-001-002C	HLWP	T1: 3; T7: CL →>
1.7 SDI (44 kW 1.7 Liter)					
07.97 → 08.99		6K - VR 000 001 →	246-069-056-001Z	N	
07.97 → 08.99			246-080-010-002Z	N-H	T7: CL →>
07.97 → 08.99			246-086-001-002C	HLWP	T1: 3; T7: CL →>
1.9 D (47 kW 1.9 Liter)					
04.93 → 08.96	1Y		246-080-010-002Z	N-H	T7: CL →>
04.93 → 08.96	1Y		246-086-001-002C	HLWP	T1: 3; T7: CL →>
1.9 SDI (47 kW 1.9 Liter)					
09.96 → 08.99	AEY	6K - VR 000 001 →	246-069-056-001Z	N	
08.96 → 08.99	AEY		246-080-010-002Z	N-H	T7: CL →>
08.96 → 08.99	AEY		246-086-001-002C	HLWP	T1: 3; T7: CL →>
1.9 D (50 kW 1.9 Liter)					
10.94 → 08.96	1Y		246-080-010-002Z	N-H	T7: CL →>
07.96 → 08.96	1Y		246-083-002-014G	SWP-D-C	T1: 6
10.94 → 08.96	1Y		246-086-001-002C	HLWP	T1: 3; T7: CL →>



			VDO		
Datum	Motorcode	Fahrgestell Nr.	Artikel Nr.	Artikelbez.	Information

SEAT**IBIZA II (6K1)****1.9 TD (55 kW | 1.9 Liter)**

03.93 → 08.96	AAZ		246-080-010-002Z	N-H	T7: CL →
03.93 → 06.96	AAZ		246-083-002-014G	SWP-D-C	T1: 6
03.93 → 08.96	AAZ		246-086-001-002C	HLWP	T1: 3; T7: CL →

1.9 TDI (66 kW | 1.9 Liter)

09.96 → 08.99	1Z / AHU	6K - VR 000 001 →	246-069-056-001Z	N	
08.96 → 08.99	1Z / AHU		246-080-010-002Z	N-H	T7: CL →
08.96 → 08.97	1Z / AHU		246-083-002-014G	SWP-D-C	T1: 6
08.96 → 08.99	1Z / AHU		246-086-001-002C	HLWP	T1: 3; T7: CL →

1.9 TDI (81 kW | 1.9 Liter)

02.97 → 08.99	AFN	6K - VR 000 001 →	246-069-056-001Z	N	
02.97 → 08.99	AFN		246-080-010-002Z	N-H	T7: CL →
03.97 → 08.99	AFN		246-083-002-014G	SWP-D-C	T1: 6
02.97 → 08.99	AFN		246-086-001-002C	HLWP	T1: 3; T7: CL →

IBIZA III (6K1)**1.0 (37 kW | 1.0 Liter)**

08.99 → 02.02	ALD / ANV / AUC		246-083-002-022G	SWP-D-C	T1: 3; T7: Stella →
08.99 → 02.02	ALD / ANV / AUC		246-086-001-002C	HLWP	T1: 3; T7: Stella →

1.0 16V (51 kW | 1.0 Liter)

05.00 → 02.02	AST / AVZ		246-083-002-022G	SWP-D-C	T1: 3
05.00 → 02.02	AST / AVZ	6K-X-400 000 →	246-086-001-007C	HLWP	T1: 3b

1.4 (44 kW | 1.4 Liter)

08.99 → 02.02	AKK / ANW / AUD		246-083-002-022G	SWP-D-C	T1: 3; T7: Stella →
08.99 → 02.02	AKK / ANW / AUD		246-086-001-002C	HLWP	T1: 3; T7: Stella →

1.4 16V (55 kW | 1.4 Liter)

05.00 → 02.02	APE / AUA		246-083-002-022G	SWP-D-C	T1: 3; T7: Stella →
05.00 → 02.02	APE / AUA		246-086-001-002C	HLWP	T1: 3; T7: Stella →

1.4 16V (74 kW | 1.4 Liter)

08.99 → 02.02	AQQ / AUB		246-083-002-022G	SWP-D-C	T1: 3; T7: Stella →
08.99 → 02.02	AQQ / AUB		246-086-001-002C	HLWP	T1: 3; T7: Stella →

1.6 (55 kW | 1.6 Liter)

08.99 → 02.02	ALM		246-083-002-022G	SWP-D-C	T1: 3; T7: Stella →
08.99 → 02.02	ALM		246-086-001-002C	HLWP	T1: 3; T7: Stella →

1.6 (74 kW | 1.6 Liter)

08.99 → 02.02	AEH / AKL / APF / AUR		246-083-002-022G	SWP-D-C	T1: 3
08.99 → 02.02	AEH / AKL / APF / AUR		246-086-001-002C	HLWP	T1: 3; T7: Stella →

1.8 T 20V Cupra (115 kW | 1.8 Liter)

07.00 → 02.02	AQX / AYP		246-083-002-022G	SWP-D-C	T1: 3; T7: Stella →
07.00 → 02.02	AQX / AYP		246-086-001-002C	HLWP	T1: 3; T7: Stella →

1.9 SDI (50 kW | 1.9 Liter)

08.99 → 02.02	AGP / AQM		246-083-002-022G	SWP-D-C	T1: 3; T7: Stella →
08.99 → 02.02	AGP / AQM		246-086-001-002C	HLWP	T1: 3; T7: Stella →



			VDO		
Datum	Motorcode	Fahrgestell Nr.	Artikel Nr.	Artikelbez.	Information

SEAT**IBIZA III (6K1)****1.9 TDI (66 kW | 1.9 Liter)**

08.99 → 02.02	AGR / ALH		246-083-002-022G	SWP-D-C	T1: 3; T7: Stella →
08.99 → 02.02	AGR / ALH		246-086-001-002C	HLWP	T1: 3; T7: Stella →

1.9 TDI (81 kW | 1.9 Liter)

08.99 → 02.02	ASK / ASV		246-083-002-022G	SWP-D-C	T1: 3; T7: Stella →
08.99 → 02.02	ASK / ASV		246-086-001-002C	HLWP	T1: 3; T7: Stella →

IBIZA IV (6L1)**1.2 (47 kW | 1.2 Liter)**

02.02 →	AZQ	6L-2-000 001 →	246-083-002-022G	SWP-D-C	T1: 3
02.02 →	AZQ	6L-2-000 001 →	246-086-001-007C	HLWP	T1: 3b

1.4 16V (55 kW | 1.4 Liter)

02.02 →	BBY		246-083-002-022G	SWP-D-C	T1: 3
02.02 →	BBY		246-086-001-007C	HLWP	T1: 3b

1.4 16V (74 kW | 1.4 Liter)

02.02 →	AUB / BBZ		246-083-002-022G	SWP-D-C	T1: 3
02.02 →	AUB / BBZ		246-086-001-007C	HLWP	T1: 3b

1.6 (74 kW | 1.6 Liter)

02.03 →	BAH		246-083-002-022G	SWP-D-C	T1: 3
02.03 →	BAH		246-086-001-007C	HLWP	T1: 3b

1.8 T FR (110 kW | 1.8 Liter)

12.03 →	BJX / BKV		246-083-002-022G	SWP-D-C	T1: 3
12.03 →	BJX / BKV		246-086-001-007C	HLWP	T1: 3b

1.8 T Cupra R (132 kW | 1.8 Liter)

01.04 →	BBU		246-083-002-022G	SWP-D-C	T1: 3
01.04 →	BBU		246-086-001-007C	HLWP	T1: 3b

1.4 TDI (55 kW | 1.4 Liter)

05.02 →	AMF		246-083-002-022G	SWP-D-C	T1: 3
05.02 →	AMF		246-086-001-007C	HLWP	T1: 3b

1.9 SDI (47 kW | 1.9 Liter)

02.02 →	ASY		246-083-002-022G	SWP-D-C	T1: 3
02.02 →	ASY		246-086-001-007C	HLWP	T1: 3b

1.9 TDI (74 kW | 1.9 Liter)

02.02 →	ATD		246-083-002-022G	SWP-D-C	T1: 3
02.02 →	ATD		246-086-001-007C	HLWP	T1: 3b

1.9 TDI (96 kW | 1.9 Liter)

02.02 →	ASZ		246-086-001-007C	HLWP	T1: 3b
---------	-----	--	------------------	------	--------

1.9 TDI Cupra R (110 kW | 1.9 Liter)

01.04 →	ARL		246-083-002-022G	SWP-D-C	T1: 3
01.04 →	ARL		246-086-001-007C	HLWP	T1: 3b

1.9 TDI Cupra R (118 kW | 1.9 Liter)

03.04 →	BPX		246-083-002-022G	SWP-D-C	T1: 3
03.04 →	BPX		246-086-001-007C	HLWP	T1: 3b



			VDO		
Datum	Motorcode	Fahrgestell Nr.	Artikel Nr.	Artikelbez.	Information

SEAT**INCA (6K9)****1.4 i (44 kW | 1.4 Liter)**

11.95 →	AEX / AKV / APQ / AUD		246-069-056-001Z	N	T7: Profi
11.95 →	AEX / AKV / APQ / AUD		246-080-010-002Z	N-H	T7: Profi
11.95 → 12.97	AEX / AKV / APQ / AUD		246-082-008-021G	SWP-M-C	T1: 6
11.95 → 12.97	AEX / AKV / APQ / AUD		246-083-002-014G	SWP-D-C	T1: 6
11.95 →	AEX / AKV / APQ / AUD	9K1 008 000 →	246-083-002-022G	SWP-D-C	T1: 3
11.95 →	AEX / AKV / APQ / AUD		246-086-001-002C	HLWP	T1: 3

1.4 16V (55 kW | 1.4 Liter)

04.00 →	AUA		246-069-056-001Z	N	T7: Profi
04.00 →	AUA		246-080-010-002Z	N-H	T7: Profi
04.00 →	AUA	9K1 008 000 →	246-083-002-022G	SWP-D-C	T1: 3
04.00 →	AUA		246-086-001-002C	HLWP	T1: 3

1.6 i (55 kW | 1.6 Liter)

11.95 → 05.98	1F		246-069-056-001Z	N	T7: Profi
11.95 → 05.98	1F		246-080-010-002Z	N-H	T7: Profi
11.95 → 05.98	1F		246-082-008-021G	SWP-M-C	T1: 6
11.95 → 05.98	1F		246-083-002-014G	SWP-D-C	T1: 6
11.95 → 05.98	1F	9K1 008 000 →	246-083-002-022G	SWP-D-C	T1: 3
11.95 → 05.98	1F		246-086-001-002C	HLWP	T1: 3

1.6 i (55 kW | 1.6 Liter)

11.95 → 05.98	AEE	→ 9K-1-008 000	246-082-008-021G	SWP-M-C	T1: 6
11.95 → 05.98	AEE	9K-1-008 001 →	246-082-008-025G	SWP-M-C	T1: 3
11.95 → 05.98	AEE	9K-1-008 001 →	246-083-002-022G	SWP-D-C	T1: 3
11.95 → 05.98	AEE	9K-1-008 001 →	246-086-001-007C	HLWP	T1: 3b

1.7 D (42 kW | 1.7 Liter)

09.96 →	AHB		246-069-056-001Z	N	T7: Profi
09.96 →	AHB		246-080-010-002Z	N-H	T7: Profi
09.96 →	AHB		246-082-008-021G	SWP-M-C	T1: 6
09.96 →	AHB		246-083-002-014G	SWP-D-C	T1: 6
09.96 →	AHB	9K1 008 000 →	246-083-002-022G	SWP-D-C	T1: 3
09.96 →	AHB		246-086-001-002C	HLWP	T1: 3

1.9 D (47 kW | 1.9 Liter)

11.95 →	1Y		246-069-056-001Z	N	T7: Profi
11.95 →	1Y		246-080-010-002Z	N-H	T7: Profi
11.95 →	1Y		246-082-008-021G	SWP-M-C	T1: 6
11.95 →	1Y		246-083-002-014G	SWP-D-C	T1: 6
11.95 →	1Y	9K1 008 000 →	246-083-002-022G	SWP-D-C	T1: 3
11.95 →	1Y		246-086-001-002C	HLWP	T1: 3

1.9 SDI (47 kW | 1.9 Liter)

11.95 →	AEY / AYQ		246-069-056-001Z	N	T7: Profi
11.95 →	AEY / AYQ		246-080-010-002Z	N-H	T7: Profi
09.96 →	AEY / AYQ		246-082-008-021G	SWP-M-C	T1: 6
09.96 →	AEY / AYQ		246-083-002-014G	SWP-D-C	T1: 6
11.95 →	AEY / AYQ	9K1 008 000 →	246-083-002-022G	SWP-D-C	T1: 3
11.95 →	AEY / AYQ		246-086-001-002C	HLWP	T1: 3



			VDO		
Datum	Motorcode	Fahrgestell Nr.	Artikel Nr.	Artikelbez.	Information

SEAT**INCA (6K9)****1.9 TDI (66 kW | 1.9 Liter)**

09.96 →	ALH		246-069-056-001Z	N	T7: Profi
09.96 →	ALH		246-080-010-002Z	N-H	T7: Profi
09.96 →	ALH	9K1 008 000 →	246-083-002-022G	SWP-D-C	T1: 3
09.96 →	ALH		246-086-001-002C	HLWP	T1: 3

LEON (1M1)**1.4 16V (55 kW | 1.4 Liter)**

11.99 →	AHW / APE / AXP / BCA		246-069-056-001Z	N	
11.99 →	AHW / APE / AXP / BCA		246-080-010-002Z	N-H	T7: Stella →
11.99 →	AHW / APE / AXP / BCA		246-082-008-025G	SWP-M-C	T1: 3
11.99 →	AHW / APE / AXP / BCA		246-086-001-002C	HLWP	T1: 3; T7: Stella →
11.99 →	AHW / APE / AXP / BCA		246-086-001-007C	HLWP	T1: 3b; T3: X11-246-003-014; T7: Stella →

1.6 (74 kW | 1.6 Liter)

11.99 →	AEH / AKL		246-069-056-001Z	N	
11.99 →	AEH / AKL		246-080-010-002Z	N-H	T7: Stella →
11.99 →	AEH / AKL		246-082-008-025G	SWP-M-C	T1: 3
11.99 →	AEH / AKL		246-086-001-002C	HLWP	T1: 3; T7: Stella →
11.99 →	AEH / AKL		246-086-001-007C	HLWP	T1: 3b; T3: X11-246-003-014; T7: Stella →

1.6 16 V (77 kW | 1.6 Liter)

09.00 →	AUS / AZD / BCB		246-069-056-001Z	N	
09.00 →	AUS / AZD / BCB		246-080-010-002Z	N-H	T7: Stella →
09.00 →	AUS / AZD / BCB		246-082-008-025G	SWP-M-C	T1: 3
09.00 →	AUS / AZD / BCB		246-086-001-002C	HLWP	T1: 3; T7: Stella →
09.00 →	AUS / AZD / BCB		246-086-001-007C	HLWP	T1: 3b; T3: X11-246-003-014; T7: Stella →

1.8 20V (92 kW | 1.8 Liter)

11.99 →	AGN / APG		246-069-056-001Z	N	
11.99 →	AGN / APG		246-080-010-002Z	N-H	T7: Stella →
11.99 →	AGN / APG		246-082-008-025G	SWP-M-C	T1: 3
11.99 →	AGN / APG		246-086-001-002C	HLWP	T1: 3; T7: Stella →
11.99 →	AGN / APG		246-086-001-007C	HLWP	T1: 3b; T3: X11-246-003-014; T7: Stella →

1.8 20V T (132 kW | 1.8 Liter)

11.99 →	APP / AUQ		246-069-056-001Z	N	
11.99 →	APP / AUQ		246-080-010-002Z	N-H	T7: Stella →
06.00 →	APP / AUQ		246-082-008-025G	SWP-M-C	T1: 3
11.99 →	APP / AUQ		246-086-001-002C	HLWP	T1: 3; T7: Stella →



			VDO		
Datum	Motorcode	Fahrgestell Nr.	Artikel Nr.	Artikelbez.	Information

SEAT**LEON (1M1)****1.8 20V T (132 kW | 1.8 Liter)**

11.99 →	APP / AUQ		246-086-001-007C	HLWP	T1: 3b; T3: X11-246-003-014; T7: Stella →
---------	-----------	--	------------------	------	-------------------------------------------------

1.8 20V T 4 (132 kW | 1.8 Liter)

11.99 →	AJQ / ARY		246-069-056-001Z	N	
11.99 →	AJQ / ARY		246-080-010-002Z	N-H	T7: Stella →
11.99 →	AJQ / ARY		246-082-008-025G	SWP-M-C	T1: 3; T7: Stella →
11.99 →	AJQ / ARY		246-086-001-002C	HLWP	T1: 3; T7: Stella →
11.99 →	AJQ / ARY		246-086-001-007C	HLWP	T1: 3b; T3: X11-246-003-014; T7: Stella →

1.8 T Cupra R (154 kW | 1.8 Liter)

02.02 →	AMK		246-069-056-001Z	N	
02.02 →	AMK		246-080-010-002Z	N-H	T7: Stella →
02.02 →	AMK		246-082-008-025G	SWP-M-C	T1: 3; T7: Stella →
02.02 →	AMK		246-086-001-002C	HLWP	T1: 3; T7: Stella →
02.02 →	AMK		246-086-001-007C	HLWP	T1: 3b; T3: X11-246-003-014; T7: Stella →

1.8 T Cupra R (165 kW | 1.8 Liter)

07.03 →	BAM		246-082-008-025G	SWP-M-C	T1: 3
07.03 →	BAM		246-083-002-022G	SWP-D-C	T1: 3
07.03 →	BAM		246-086-001-007C	HLWP	T1: 3b

2.8 Cupra 4 (150 kW | 2.8 Liter)

02.01 →	AUE		246-069-056-001Z	N	
02.01 →	AUE		246-080-010-002Z	N-H	T7: Stella →
02.01 →	AUE		246-082-008-025G	SWP-M-C	T1: 3; T7: Stella →
02.01 →	AUE		246-086-001-002C	HLWP	T1: 3; T7: Stella →
02.01 →	AUE		246-086-001-007C	HLWP	T1: 3b; T3: X11-246-003-014; T7: Stella →

1.9 SDI (50 kW | 1.9 Liter)

11.99 →	AQM		246-069-056-001Z	N	
11.99 →	AQM		246-080-010-002Z	N-H	T7: Stella →
06.00 →	AQM		246-082-008-025G	SWP-M-C	T1: 3
11.99 →	AQM		246-086-001-002C	HLWP	T1: 3; T7: Stella →
11.99 →	AQM		246-086-001-007C	HLWP	T1: 3b; T3: X11-246-003-014; T7: Stella →

1.9 TDI (66 kW | 1.9 Liter)

11.99 →	AGR / ALH		246-069-056-001Z	N	
11.99 →	AGR / ALH		246-080-010-002Z	N-H	T7: Stella →
11.99 →	AGR / ALH		246-082-008-025G	SWP-M-C	T1: 3
11.99 →	AGR / ALH		246-086-001-002C	HLWP	T1: 3; T7: Stella →



			VDO		
Datum	Motorcode	Fahrgestell Nr.	Artikel Nr.	Artikelbez.	Information

SEAT**LEON (1M1)****1.9 TDI (66 kW | 1.9 Liter)**

11.99 →	AGR / ALH		246-086-001-007C	HLWP	T1: 3b; T3: X11-246-003-014; T7: Stella →
---------	-----------	--	------------------	------	-------------------------------------------------

1.9 TDI (81 kW | 1.9 Liter)

11.99 →	AHF / ASV		246-069-056-001Z	N	
11.99 →	AHF / ASV		246-080-010-002Z	N-H	T7: Stella →
11.99 →	AHF / ASV		246-082-008-025G	SWP-M-C	T1: 3
11.99 →	AHF / ASV		246-086-001-002C	HLWP	T1: 3; T7: Stella →
11.99 →	AHF / ASV		246-086-001-007C	HLWP	T1: 3b; T3: X11-246-003-014; T7: Stella →

1.9 TDI (96 kW | 1.9 Liter)

05.03 →	ASZ		246-082-008-025G	SWP-M-C	T1: 3
05.03 →	ASZ		246-083-002-022G	SWP-D-C	T1: 3
05.03 →	ASZ		246-086-001-007C	HLWP	T1: 3b

1.9 TDI (110 kW | 1.9 Liter)

02.01 →	ARL		246-069-056-001Z	N	
02.01 →	ARL		246-080-010-002Z	N-H	T7: Stella →
02.01 →	ARL		246-082-008-025G	SWP-M-C	T1: 3; T7: Stella →
02.01 →	ARL		246-086-001-002C	HLWP	T1: 3; T7: Stella →
02.01 →	ARL		246-086-001-007C	HLWP	T1: 3b; T3: X11-246-003-014; T7: Stella →

1.9 TDI Syncro (110 kW | 1.9 Liter)

05.02 →	ARL		246-082-008-025G	SWP-M-C	T1: 3
05.02 →	ARL		246-083-002-022G	SWP-D-C	T1: 3
05.02 →	ARL		246-086-001-007C	HLWP	T1: 3b

LEON (1P1)**1.4 16V (55 kW | 1.4 Liter)**

09.05 →		1P-6-000 001 →	246-083-002-022G	SWP-D-C	T1: 3
09.05 →		1P-6-000 001 →	246-086-001-007C	HLWP	T1: 3b

1.6 (75 kW | 1.6 Liter)

09.05 →	BSE / BSF	1P-6-000 001 →	246-083-002-022G	SWP-D-C	T1: 3
09.05 →	BSE / BSF	1P-6-000 001 →	246-086-001-007C	HLWP	T1: 3b

1.6 16V (77 kW | 1.6 Liter)

09.05 →		1P-6-000 001 →	246-083-002-022G	SWP-D-C	T1: 3
09.05 →		1P-6-000 001 →	246-086-001-007C	HLWP	T1: 3b

1.8 T 20V (132 kW | 1.8 Liter)

09.05 →		1P-6-000 001 →	246-083-002-022G	SWP-D-C	T1: 3
09.05 →		1P-6-000 001 →	246-086-001-007C	HLWP	T1: 3b



			VDO		
Datum	Motorcode	Fahrgestell Nr.	Artikel Nr.	Artikelbez.	Information

SEAT**LEON (1P1)****1.8 T 20V (165 kW | 1.8 Liter)**

09.05 →		1P-6-000 001 →	246-083-002-022G	SWP-D-C	T1: 3
09.05 →		1P-6-000 001 →	246-086-001-007C	HLWP	T1: 3b

2.0 FSI (110 kW | 2.0 Liter)

09.05 →	BLR / BLY / BVY / BVZ	1P-6-000 001 →	246-083-002-022G	SWP-D-C	T1: 3
09.05 →	BLR / BLY / BVY / BVZ	1P-6-000 001 →	246-086-001-007C	HLWP	T1: 3b

2.0 TFSI (136 kW | 2.0 Liter)

09.05 →		1P-6-000 001 →	246-083-002-022G	SWP-D-C	T1: 3
09.05 →		1P-6-000 001 →	246-086-001-007C	HLWP	T1: 3b

1.9 TDI (77 kW | 1.9 Liter)

09.05 →	BKC / BLS	1P-6-000 001 →	246-083-002-022G	SWP-D-C	T1: 3
09.05 →	BKC / BLS	1P-6-000 001 →	246-086-001-007C	HLWP	T1: 3b

1.9 TDI (81 kW | 1.9 Liter)

09.05 →		1P-6-000 001 →	246-083-002-022G	SWP-D-C	T1: 3
09.05 →		1P-6-000 001 →	246-086-001-007C	HLWP	T1: 3b

1.9 TDI (110 kW | 1.9 Liter)

09.05 →		1P-6-000 001 →	246-083-002-022G	SWP-D-C	T1: 3
09.05 →		1P-6-000 001 →	246-086-001-007C	HLWP	T1: 3b

2.0 TDI (103 kW | 2.0 Liter)

09.05 →	BKD / BMM	1P-6-000 001 →	246-083-002-022G	SWP-D-C	T1: 3
09.05 →	BKD / BMM	1P-6-000 001 →	246-086-001-007C	HLWP	T1: 3b

TOLEDO I (1L)**1.6 i (52 kW | 1.6 Liter)**

05.91 → 12.93	1F		246-080-010-002Z	N-H	T7: CL →→
05.91 → 12.93	1F		246-082-008-014C	SWP-M-C	T1: 1

1.6 i (54 kW | 1.6 Liter)

05.91 → 03.99	1F / ABN / EZ		246-080-010-002Z	N-H	T7: CL →→
05.91 → 03.99	1F / ABN / EZ		246-082-008-014C	SWP-M-C	T1: 1

1.6 i (55 kW | 1.6 Liter)

01.93 → 03.99	1F		246-080-010-002Z	N-H	T7: CL →→
01.93 → 03.99	1F		246-082-008-014C	SWP-M-C	T1: 1

1.6 i (74 kW | 1.6 Liter)

11.96 → 03.99	AFT		246-080-010-002Z	N-H	T7: CL →→
11.96 → 03.99	AFT		246-082-008-014C	SWP-M-C	T1: 1

1.8 i (65 kW | 1.8 Liter)

05.91 → 12.96	RP		246-080-010-002Z	N-H	T7: CL →→
05.91 → 12.96	RP		246-082-008-014C	SWP-M-C	T1: 1

1.8 i (66 kW | 1.8 Liter)

11.93 → 12.96	ABS / ADZ		246-080-010-002Z	N-H	T7: CL →→
11.93 → 12.96	ABS / ADZ		246-082-008-014C	SWP-M-C	T1: 1

1.8 16V (92 kW | 1.8 Liter)

05.91 → 03.99	PL		246-080-010-002Z	N-H	T7: CL →→
05.91 → 03.99	PL		246-082-008-014C	SWP-M-C	T1: 1



			VDO		
Datum	Motorcode	Fahrgestell Nr.	Artikel Nr.	Artikelbez.	Information

SEAT**TOLEDO I (1L)****1.8 16V (98 kW | 1.8 Liter)**

05.91 → 03.99	KR		246-080-010-002Z	N-H	T7: CL →
05.91 → 03.99	KR		246-082-008-014C	SWP-M-C	T1: 1

2.0 i (85 kW | 2.0 Liter)

05.91 → 03.99	2E / AGG		246-080-010-002Z	N-H	T7: CL →
05.91 → 03.99	2E / AGG		246-082-008-014C	SWP-M-C	T1: 1

2.0 i 16V (110 kW | 2.0 Liter)

11.93 → 03.99	ABF		246-080-010-002Z	N-H	T7: CL →
11.93 → 03.99	ABF		246-082-008-014C	SWP-M-C	T1: 1

1.9 D (47 kW | 1.9 Liter)

12.95 → 03.99	1Y		246-080-010-002Z	N-H	T7: CL →
12.95 → 03.99	1Y		246-082-008-014C	SWP-M-C	T1: 1

1.9 SDI (47 kW | 1.9 Liter)

12.95 → 03.99	1Y		246-080-010-002Z	N-H	T7: CL →
12.95 → 03.99	1Y		246-082-008-014C	SWP-M-C	T1: 1

1.9 D (50 kW | 1.9 Liter)

05.91 → 03.99	1Y		246-080-010-002Z	N-H	T7: CL →
05.91 → 03.99	1Y		246-082-008-014C	SWP-M-C	T1: 1

1.9 TD (55 kW | 1.9 Liter)

05.91 → 03.99	AAZ		246-080-010-002Z	N-H	T7: CL →
05.91 → 03.99	AAZ		246-082-008-014C	SWP-M-C	T1: 1

1.9 TDI (66 kW | 1.9 Liter)

08.95 → 03.99	1Z / AHU		246-080-010-002Z	N-H	T7: CL →
08.95 → 03.99	1Z / AHU		246-082-008-014C	SWP-M-C	T1: 1

1.9 TDI (81 kW | 1.9 Liter)

11.96 → 03.99	AFN		246-080-010-002Z	N-H	T7: CL →
11.96 → 03.99	AFN		246-082-008-014C	SWP-M-C	T1: 1

TOLEDO II (1M2)**1.4 16V (55 kW | 1.4 Liter)**

07.99 →	AHW / AXP		246-069-056-001Z	N	
07.99 →	AHW / AXP		246-080-010-002Z	N-H	T7: Stella →
01.00 →	AHW / AXP		246-082-008-025G	SWP-M-C	T1: 3
07.99 →	AHW / AXP		246-086-001-002C	HLWP	T1: 3; T7: Stella →

1.6 (74 kW | 1.6 Liter)

04.99 → 09.00	AEH / AKL		246-069-056-001Z	N	
04.99 → 09.00	AEH / AKL		246-080-010-002Z	N-H	T7: Stella →
04.99 → 09.00	AEH / AKL		246-086-001-002C	HLWP	T1: 3; T7: Stella →

1.6 16V (77 kW | 1.6 Liter)

09.00 →	AUS / AZD		246-069-056-001Z	N	
09.00 →	AUS / AZD		246-080-010-002Z	N-H	T7: Stella →
09.00 →	AUS / AZD		246-082-008-025G	SWP-M-C	T1: 3; T7: Stella →
09.00 →	AUS / AZD		246-086-001-002C	HLWP	T1: 3; T7: Stella →



			VDO		
Datum	Motorcode	Fahrgestell Nr.	Artikel Nr.	Artikelbez.	Information

SEAT**TOLEDO II (1M2)****1.8 20V (92 kW | 1.8 Liter)**

04.99 →	AGN / APG		246-069-056-001Z	N	
04.99 →	AGN / APG		246-080-010-002Z	N-H	T7: Stella →
04.99 → 04.99	AGN / APG		246-082-008-025G	SWP-M-C	T1: 3
04.99 →	AGN / APG		246-086-001-002C	HLWP	T1: 3; T7: Stella →

1.8 20VT (132 kW | 1.8 Liter)

05.01 →	AUQ		246-082-008-025G	SWP-M-C	T1: 3
05.01 →	AUQ	1M-X-000 001 →; → 1M-X-025 000	246-083-002-022G	SWP-D-C	T1: 3
05.01 →	AUQ	1M-X-000 001 →; → 1M-X-025 000	246-086-001-007C	HLWP	T1: 3b

2.3 V5 (110 kW | 2.3 Liter)

04.99 → 05.01	AGZ		246-069-056-001Z	N	
04.99 → 05.01	AGZ		246-080-010-002Z	N-H	T7: Stella →
04.99 → 04.99	AGZ		246-082-008-025G	SWP-M-C	T1: 3
04.99 → 05.01	AGZ		246-086-001-002C	HLWP	T1: 3; T7: Stella →

2.3 V5 20V (125 kW | 2.3 Liter)

05.01 →	AQN		246-069-056-001Z	N	
05.01 →	AQN		246-080-010-002Z	N-H	T7: Stella →
05.01 →	AQN		246-082-008-025G	SWP-M-C	T1: 3; T7: Stella →
05.01 →	AQN		246-086-001-002C	HLWP	T1: 3; T7: Stella →

1.9 SDI (50 kW | 1.9 Liter)

11.99 → 06.04			246-082-008-025G	SWP-M-C	T1: 3
11.99 → 06.04		1M-X-000 001 →; → 1M-X-025 000	246-083-002-022G	SWP-D-C	T1: 3
11.99 → 06.04		1M-X-000 001 →; → 1M-X-025 000	246-086-001-007C	HLWP	T1: 3b

1.9 TDI (66 kW | 1.9 Liter)

04.99 →	AGR / ALH		246-069-056-001Z	N	
04.99 →	AGR / ALH		246-080-010-002Z	N-H	T7: Stella →
04.99 → 04.99	AGR / ALH		246-082-008-025G	SWP-M-C	T1: 3
04.99 →	AGR / ALH		246-086-001-002C	HLWP	T1: 3; T7: Stella →

1.9 TDI (81 kW | 1.9 Liter)

04.99 →	AHF / ASV		246-069-056-001Z	N	
04.99 →	AHF / ASV		246-080-010-002Z	N-H	T7: Stella →
04.99 → 04.99	AHF / ASV		246-082-008-025G	SWP-M-C	T1: 3
04.99 →	AHF / ASV		246-086-001-002C	HLWP	T1: 3; T7: Stella →

1.9 TDI (96 kW | 1.9 Liter)

05.03 →	ASZ		246-082-008-025G	SWP-M-C	T1: 3
05.03 →	ASZ	1M-X-000 001 →; → 1M-X-025 000	246-083-002-022G	SWP-D-C	T1: 3
05.03 →	ASZ	1M-X-000 001 →; → 1M-X-025 000	246-086-001-007C	HLWP	T1: 3b



			VDO		
Datum	Motorcode	Fahrgestell Nr.	Artikel Nr.	Artikelbez.	Information

SEAT**TOLEDO II (1M2)****1.9 TDI (110 kW | 1.9 Liter)**

10.00 →	ARL		246-069-056-001Z	N	
10.00 →	ARL		246-080-010-002Z	N-H	T7: Stella →
10.00 →	ARL		246-082-008-025G	SWP-M-C	T1: 3; T7: Stella →
10.00 →	ARL		246-086-001-002C	HLWP	T1: 3; T7: Stella →

TOLEDO III (5P2)**1.6 (75 kW | 1.6 Liter)**

10.04 →	BGU / BSE / BSF		246-083-002-022G	SWP-D-C	T1: 3
10.04 →	BGU / BSE / BSF		246-086-001-007C	HLWP	T1: 3b

2.0 FSI (110 kW | 2.0 Liter)

10.04 →	BLR / BLY		246-083-002-022G	SWP-D-C	T1: 3
10.04 →	BLR / BLY		246-086-001-007C	HLWP	T1: 3b

1.9 TDI (77 kW | 1.9 Liter)

10.04 →	BJB / BKC		246-083-002-022G	SWP-D-C	T1: 3
10.04 →	BJB / BKC		246-086-001-007C	HLWP	T1: 3b

2.0 TDI (103 kW | 2.0 Liter)

10.04 →	BKD		246-083-002-022G	SWP-D-C	T1: 3
10.04 →	BKD		246-086-001-007C	HLWP	T1: 3b

SKODA**FABIA (6Y2)****1.0 (37 kW | 1.0 Liter)**

12.99 → 08.02	AQV / ARV / ATY		246-082-008-025G	SWP-M-C	T1: 3; T7: Classic →
12.99 → 08.02	AQV / ARV / ATY		246-083-002-022G	SWP-D-C	T1: 3
12.99 → 08.02	AQV / ARV / ATY		246-086-001-002C	HLWP	T1: 3

1.2 (40 kW | 1.2 Liter)

08.02 →	AWY / BMD		246-082-008-025G	SWP-M-C	T1: 3
08.02 →	AWY / BMD		246-083-002-022G	SWP-D-C	T1: 3

1.2 (47 kW | 1.2 Liter)

01.03 →	AZQ / BME		246-082-008-025G	SWP-M-C	T1: 3
01.03 →	AZQ / BME		246-083-002-022G	SWP-D-C	T1: 3

1.4 (44 kW | 1.4 Liter)

08.00 → 08.02	AZE / AZF		246-082-008-025G	SWP-M-C	T1: 3; T7: Classic →
08.00 → 08.02	AZE / AZF		246-083-002-022G	SWP-D-C	T1: 3

1.4 (50 kW | 1.4 Liter)

08.99 →	AME / AQW / ATZ		246-082-008-025G	SWP-M-C	T1: 3; T7: Classic →
10.99 →	AME / AQW / ATZ		246-083-002-022G	SWP-D-C	T1: 3
10.99 →	AME / AQW / ATZ		246-086-001-002C	HLWP	T1: 3



			VDO		
Datum	Motorcode	Fahrgestell Nr.	Artikel Nr.	Artikelbez.	Information

SKODA**FABIA (6Y2)****1.4 16V (55 kW | 1.4 Liter)**

12.99 →	AUA / BBY / BKY		246-082-008-025G	SWP-M-C	T1: 3; T7: Classic →
12.99 →	AUA / BBY / BKY		246-083-002-022G	SWP-D-C	T1: 3

1.4 16V (74 kW | 1.4 Liter)

12.99 →	AUB / BBZ		246-082-008-025G	SWP-M-C	T1: 3; T7: Classic →
12.99 →	AUB / BBZ		246-083-002-022G	SWP-D-C	T1: 3
12.99 →	AUB / BBZ		246-086-001-002C	HLWP	T1: 3

2.0 (85 kW | 2.0 Liter)

12.99 →	AQY / AZL		246-082-008-025G	SWP-M-C	T1: 3; T7: Classic →
12.99 →	AQY / AZL		246-083-002-022G	SWP-D-C	T1: 3

1.4 TDI (55 kW | 1.4 Liter)

04.03 →	AMF		246-082-008-025G	SWP-M-C	T1: 3
04.03 →	AMF		246-083-002-022G	SWP-D-C	T1: 3

1.9 SDI (47 kW | 1.9 Liter)

12.99 →	ASY		246-082-008-025G	SWP-M-C	T1: 3; T7: Classic →
12.99 →	ASY		246-083-002-022G	SWP-D-C	T1: 3
12.99 →	ASY		246-086-001-002C	HLWP	T1: 3

1.9 TDI (74 kW | 1.9 Liter)

01.00 →	ATD		246-082-008-025G	SWP-M-C	T1: 3; T7: Classic →
02.00 →	ATD		246-083-002-022G	SWP-D-C	T1: 3
02.00 →	ATD		246-086-001-002C	HLWP	T1: 3

RS (96 kW | 1.9 Liter)

06.03 →	ASZ		246-082-008-025G	SWP-M-C	T1: 3
06.03 →	ASZ		246-083-002-022G	SWP-D-C	T1: 3

FABIA Stufenheck (6Y3)**1.2 (40 kW | 1.2 Liter)**

07.01 →	AWY / BMD		246-086-001-007C	HLWP	T1: 3b
---------	-----------	--	------------------	------	--------

1.2 (47 kW | 1.2 Liter)

01.03 →	AZQ / BME		246-082-008-025G	SWP-M-C	T1: 3
---------	-----------	--	------------------	---------	-------

1.4 (44 kW | 1.4 Liter)

04.00 → 08.02	AZE / AZF		246-086-001-007C	HLWP	T1: 3b
---------------	-----------	--	------------------	------	--------

1.4 (50 kW | 1.4 Liter)

07.01 →	AME / AQW		246-082-008-025G	SWP-M-C	T1: 3
---------	-----------	--	------------------	---------	-------

1.4 16V (55 kW | 1.4 Liter)

10.99 →	AUA / BBY / BKY		246-082-008-025G	SWP-M-C	T1: 3
---------	-----------------	--	------------------	---------	-------

1.4 16V (74 kW | 1.4 Liter)

12.99 →	AUB / BBZ		246-082-008-025G	SWP-M-C	T1: 3
---------	-----------	--	------------------	---------	-------

2.0 (85 kW | 2.0 Liter)

12.99 →	AZL		246-082-008-025G	SWP-M-C	T1: 3
---------	-----	--	------------------	---------	-------

1.4 TDI (55 kW | 1.4 Liter)

04.03 →	AMF		246-082-008-025G	SWP-M-C	T1: 3
---------	-----	--	------------------	---------	-------

1.9 SDI (47 kW | 1.9 Liter)

11.99 →	ASY		246-082-008-025G	SWP-M-C	T1: 3
---------	-----	--	------------------	---------	-------



			VDO		
Datum	Motorcode	Fahrgestell Nr.	Artikel Nr.	Artikelbez.	Information

SKODA**FABIA Stufenheck (6Y3)****1.9 TDI (74 kW | 1.9 Liter)**

01.00 →	ATD		246-082-008-025G	SWP-M-C	T1: 3
---------	-----	--	------------------	---------	-------

FABIA Combi (6Y5)**1.2 (47 kW | 1.2 Liter)**

01.03 →	AZQ / BME		246-086-001-007C	HLWP	T1: 3b
---------	-----------	--	------------------	------	--------

1.4 (44 kW | 1.4 Liter)

04.00 →	AZE / AZF		246-086-001-007C	HLWP	T1: 3b
---------	-----------	--	------------------	------	--------

1.4 (50 kW | 1.4 Liter)

04.00 →	AME / AQW / ATZ		246-086-001-007C	HLWP	T1: 3b
---------	-----------------	--	------------------	------	--------

1.4 16V (55 kW | 1.4 Liter)

05.00 →	AUA / BBY / BKY		246-086-001-007C	HLWP	T1: 3b
---------	-----------------	--	------------------	------	--------

1.4 16V (74 kW | 1.4 Liter)

04.00 →	AUB / BBZ		246-086-001-007C	HLWP	T1: 3b
---------	-----------	--	------------------	------	--------

2.0 (85 kW | 2.0 Liter)

04.00 →	AZL		246-086-001-007C	HLWP	T1: 3b
---------	-----	--	------------------	------	--------

1.4 TDI (55 kW | 1.4 Liter)

04.03 →	AMF		246-086-001-007C	HLWP	T1: 3b
---------	-----	--	------------------	------	--------

1.9 SDI (47 kW | 1.9 Liter)

04.00 →	ASY		246-086-001-007C	HLWP	T1: 3b
---------	-----	--	------------------	------	--------

1.9 TDI (74 kW | 1.9 Liter)

04.00 →	ATD		246-086-001-007C	HLWP	T1: 3b
---------	-----	--	------------------	------	--------

OCTAVIA (1U2)**1.4 (44 kW | 1.4 Liter)**

04.99 →	AMD		246-082-008-025G	SWP-M-C	T1: 3; T7: LX →>
---------	-----	--	------------------	---------	------------------

04.99 →	AMD		246-083-002-022G	SWP-D-C	T1: 3; T8
---------	-----	--	------------------	---------	-----------

04.99 →	AMD		246-086-001-007C	HLWP	T1: 3b; T3: X11-246-003-014; T7: LX →>
---------	-----	--	------------------	------	----------------------------------------------

1.4 16V (55 kW | 1.4 Liter)

09.00 →	AXP / BCA		246-082-008-025G	SWP-M-C	T1: 3; T7: LX →>
---------	-----------	--	------------------	---------	------------------

09.00 →	AXP / BCA		246-083-002-022G	SWP-D-C	T1: 3; T8
---------	-----------	--	------------------	---------	-----------

09.00 →	AXP / BCA		246-086-001-007C	HLWP	T1: 3b; T3: X11-246-003-014; T7: LX →>
---------	-----------	--	------------------	------	----------------------------------------------

1.6 (55 kW | 1.6 Liter)

10.96 → 09.00	AEE		246-082-008-025G	SWP-M-C	T1: 3
---------------	-----	--	------------------	---------	-------

10.96 → 07.98	AEE		246-083-002-022G	SWP-D-C	T1: 3
---------------	-----	--	------------------	---------	-------

10.96 → 07.98	AEE		246-086-001-002C	HLWP	T1: 3
---------------	-----	--	------------------	------	-------

09.96 → 09.00	AEE		246-086-001-007C	HLWP	T1: 3b; T3: X11-246-003-014; T7: LX →>
---------------	-----	--	------------------	------	----------------------------------------------



			VDO		
Datum	Motorcode	Fahrgestell Nr.	Artikel Nr.	Artikelbez.	Information

SKODA**OCTAVIA (1U2)****1.6 (74 kW | 1.6 Liter)**

02.97 →	AEH / AKL		246-082-008-025G	SWP-M-C	T1: 3
02.97 → 12.97	AEH / AKL		246-083-002-022G	SWP-D-C	T1: 3
02.97 → 12.97	AEH / AKL		246-086-001-002C	HLWP	T1: 3
02.97 →	AEH / AKL		246-086-001-007C	HLWP	T1: 3b; T3: X11-246-003-014; T7: LX →

1.6 (75 kW | 1.6 Liter)

11.00 →	AVU / BFQ		246-082-008-025G	SWP-M-C	T1: 3; T7: LX →
11.00 →	AVU / BFQ		246-083-002-022G	SWP-D-C	T1: 3; T8
11.00 →	AVU / BFQ		246-086-001-007C	HLWP	T1: 3b; T3: X11-246-003-014; T7: LX →

1.8 (92 kW | 1.8 Liter)

10.96 →	AGN		246-082-008-025G	SWP-M-C	T1: 3
10.96 → 04.99	AGN		246-083-002-022G	SWP-D-C	T1: 3
10.96 → 04.99	AGN		246-086-001-002C	HLWP	T1: 3
09.96 →	AGN		246-086-001-007C	HLWP	T1: 3b; T3: X11-246-003-014; T7: LX →

1.8 T (110 kW | 1.8 Liter)

08.97 →	AGU / ARX / ARZ / AUM		246-082-008-025G	SWP-M-C	T1: 3
08.97 → 04.99	AGU / ARX / ARZ / AUM		246-083-002-022G	SWP-D-C	T1: 3
08.97 → 04.99	AGU / ARX / ARZ / AUM		246-086-001-002C	HLWP	T1: 3
08.97 →	AGU / ARX / ARZ / AUM		246-086-001-007C	HLWP	T1: 3b; T3: X11-246-003-014; T7: LX →

1.8 T 4x4 (110 kW | 1.8 Liter)

05.01 →	AGU / ARX / AUM		246-082-008-025G	SWP-M-C	T1: 3; T7: LX →
05.01 →	AGU / ARX / AUM		246-083-002-022G	SWP-D-C	T1: 3; T8
05.01 →	AGU / ARX / AUM		246-086-001-007C	HLWP	T1: 3b; T3: X11-246-003-014; T7: LX →

RS 1.8 T (132 kW | 1.8 Liter)

05.01 →	AUQ		246-082-008-025G	SWP-M-C	T1: 3; T7: LX →
05.01 →	AUQ		246-083-002-022G	SWP-D-C	T1: 3; T8
05.01 →	AUQ		246-086-001-007C	HLWP	T1: 3b; T3: X11-246-003-014; T7: LX →

2.0 (85 kW | 2.0 Liter)

05.99 →	AEG / APK / AQY / AZH		246-082-008-025G	SWP-M-C	T1: 3
05.99 →	AEG / APK / AQY / AZH		246-083-002-022G	SWP-D-C	T1: 3
05.99 →	AEG / APK / AQY / AZH		246-086-001-002C	HLWP	T1: 3



			VDO		
Datum	Motorcode	Fahrgestell Nr.	Artikel Nr.	Artikelbez.	Information

SKODA**OCTAVIA (1U2)****2.0 (85 kW | 2.0 Liter)**

04.99 →	AEG / APK / AQY / AZH		246-086-001-007C	HLWP	T1: 3b; T3: X11-246-003-014; T7: LX →
---------	-----------------------	--	------------------	------	---------------------------------------------

1.9 SDI (50 kW | 1.9 Liter)

06.97 →	AGP / AQM		246-082-008-025G	SWP-M-C	T1: 3
06.97 →	AGP / AQM		246-083-002-022G	SWP-D-C	T1: 3
06.97 →	AGP / AQM		246-086-001-002C	HLWP	T1: 3
06.97 →	AGP / AQM		246-086-001-007C	HLWP	T1: 3b; T3: X11-246-003-014; T7: LX →

1.9 TDI (66 kW | 1.9 Liter)

10.96 →	AGR / ALH		246-082-008-025G	SWP-M-C	T1: 3
10.96 →	AGR / ALH		246-083-002-022G	SWP-D-C	T1: 3
10.96 →	AGR / ALH		246-086-001-002C	HLWP	T1: 3
09.96 →	AGR / ALH		246-086-001-007C	HLWP	T1: 3b; T3: X11-246-003-014; T7: LX →

1.9 TDI (81 kW | 1.9 Liter)

08.97 →	AHF / ASV		246-082-008-025G	SWP-M-C	T1: 3; T7: LX →
08.97 →	AHF / ASV		246-083-002-022G	SWP-D-C	T1: 3; T8
08.97 →	AHF / ASV		246-086-001-007C	HLWP	T1: 3b; T3: X11-246-003-014; T7: LX →

1.9 TDI (96 kW | 1.9 Liter)

01.03 →	ASZ		246-082-008-025G	SWP-M-C	T1: 3
---------	-----	--	------------------	---------	-------

OCTAVIA Combi (1U5)**1.4 16V (55 kW | 1.4 Liter)**

08.00 →	AXP / BCA		246-083-002-022G	SWP-D-C	T1: 3
08.00 →	AXP / BCA		246-086-001-007C	HLWP	T1: 3b; T3: X11-246-003-014
08.00 →	AXP / BCA		246-086-001-007C	HLWP	T1: 3b; T3: X11-246-003-014; T7: LX →

1.6 (55 kW | 1.6 Liter)

07.98 →	AEE		246-082-008-025G	SWP-M-C	T1: 3
07.98 →	AEE		246-083-002-022G	SWP-D-C	T1: 3
07.98 →	AEE		246-086-001-002C	HLWP	T1: 3
07.98 →	AEE		246-086-001-007C	HLWP	T1: 3b; T3: X11-246-003-014; T7: LX →



			VDO		
Datum	Motorcode	Fahrgestell Nr.	Artikel Nr.	Artikelbez.	Information

SKODA**OCTAVIA Combi (1U5)****1.6 (74 kW | 1.6 Liter)**

07.98 → 07.98	AEH / AKL		246-082-008-025G	SWP-M-C	T1: 3
07.98 →	AEH / AKL		246-083-002-022G	SWP-D-C	T1: 3
07.98 → 07.98	AEH / AKL		246-086-001-002C	HLWP	T1: 3
07.98 →	AEH / AKL		246-086-001-007C	HLWP	T1: 3b; T3: X11-246-003-014; T7: LX →

1.6 (75 kW | 1.6 Liter)

09.00 →	AVU / BFQ		246-083-002-022G	SWP-D-C	T1: 3
09.00 →	AVU / BFQ		246-086-001-007C	HLWP	T1: 3b; T3: X11-246-003-014; T7: LX →

1.8 20V (92 kW | 1.8 Liter)

08.98 → 04.99	AGN		246-082-008-025G	SWP-M-C	T1: 3
08.98 →	AGN		246-083-002-022G	SWP-D-C	T1: 3
08.98 → 04.99	AGN		246-086-001-002C	HLWP	T1: 3
07.98 →	AGN		246-086-001-007C	HLWP	T1: 3b; T3: X11-246-003-014; T7: LX →

1.8 T (110 kW | 1.8 Liter)

07.98 → 07.98	AGU / ARX / ARZ / AUM		246-082-008-025G	SWP-M-C	T1: 3
07.98 →	AGU / ARX / ARZ / AUM		246-083-002-022G	SWP-D-C	T1: 3
07.98 → 07.98	AGU / ARX / ARZ / AUM		246-086-001-002C	HLWP	T1: 3
07.98 →	AGU / ARX / ARZ / AUM		246-086-001-007C	HLWP	T1: 3b; T3: X11-246-003-014; T7: LX →

1.8 T 4x4 (110 kW | 1.8 Liter)

05.01 →	AGU / ARX / AUM		246-083-002-022G	SWP-D-C	T1: 3
05.01 →	AGU / ARX / AUM		246-086-001-007C	HLWP	T1: 3b; T3: X11-246-003-014; T7: LX →

RS 1.8 T (132 kW | 1.8 Liter)

08.02 →	AUQ		246-083-002-022G	SWP-D-C	T1: 3
---------	-----	--	------------------	---------	-------

2.0 (85 kW | 2.0 Liter)

11.99 →	AEG / APK / AQY / AZH		246-082-008-025G	SWP-M-C	T1: 3
11.99 →	AEG / APK / AQY / AZH		246-083-002-022G	SWP-D-C	T1: 3
11.99 →	AEG / APK / AQY / AZH		246-086-001-002C	HLWP	T1: 3
04.99 →	AEG / APK / AQY / AZH		246-086-001-007C	HLWP	T1: 3b; T3: X11-246-003-014; T7: LX →

2.0 4x4 (85 kW | 2.0 Liter)

05.01 →	AEG / AQY / AZH / AZJ		246-083-002-022G	SWP-D-C	T1: 3
05.01 →	AEG / AQY / AZH / AZJ		246-086-001-007C	HLWP	T1: 3b; T3: X11-246-003-014; T7: LX →



			VDO		
Datum	Motorcode	Fahrgestell Nr.	Artikel Nr.	Artikelbez.	Information

SKODA**OCTAVIA Combi (1U5)****2.0 (88 kW | 2.0 Liter)**

01.00 →	ATF		246-083-002-022G	SWP-D-C	T1: 3
01.00 →	ATF		246-086-001-007C	HLWP	T1: 3b; T3: X11-246-003-014; T7: LX →

1.9 SDI (50 kW | 1.9 Liter)

08.98 →	AGP / AQM		246-082-008-025G	SWP-M-C	T1: 3
08.98 →	AGP / AQM		246-083-002-022G	SWP-D-C	T1: 3
08.98 →	AGP / AQM		246-086-001-002C	HLWP	T1: 3
07.98 →	AGP / AQM		246-086-001-007C	HLWP	T1: 3b; T3: X11-246-003-014; T7: LX →

1.9 TDI (66 kW | 1.9 Liter)

07.98 → 07.98	AGR / ALH		246-082-008-025G	SWP-M-C	T1: 3
07.98 →	AGR / ALH		246-083-002-022G	SWP-D-C	T1: 3
07.98 → 07.98	AGR / ALH		246-086-001-002C	HLWP	T1: 3
07.98 →	AGR / ALH		246-086-001-007C	HLWP	T1: 3b; T3: X11-246-003-014; T7: LX →

1.9 TDI 4x4 (66 kW | 1.9 Liter)

11.99 → 09.00	AGR		246-082-008-025G	SWP-M-C	T1: 3
11.99 → 09.00	AGR		246-083-002-022G	SWP-D-C	T1: 3
11.99 → 09.00	AGR		246-086-001-002C	HLWP	T1: 3
11.99 → 09.00	AGR		246-086-001-007C	HLWP	T1: 3b; T3: X11-246-003-014; T7: LX →

1.9 TDI 4x4 (74 kW | 1.9 Liter)

09.00 →	ATD		246-083-002-022G	SWP-D-C	T1: 3
09.00 →	ATD		246-086-001-007C	HLWP	T1: 3b; T3: X11-246-003-014; T7: LX →





1.9 TDI (81 kW | 1.9 Liter)

10.98 → 12.00	AHF / ASV		246-082-008-025G	SWP-M-C	T1: 3
10.00 →	AHF / ASV		246-083-002-022G	SWP-D-C	T1: 3
10.00 →	AHF / ASV		246-086-001-002C	HLWP	T1: 3
07.98 →	AHF / ASV		246-086-001-007C	HLWP	T1: 3b; T3: X11-246-003-014; T7: LX →

1.9 TDI (96 kW | 1.9 Liter)

01.03 →	ASZ		246-083-002-022G	SWP-D-C	T1: 3
---------	-----	--	------------------	---------	-------



			VDO		
Datum	Motorcode	Fahrgestell Nr.	Artikel Nr.	Artikelbez.	Information

SKODA**OCTAVIA (1Z3)****1.4 (55 kW | 1.4 Liter)**

06.04 →	BCA	→ 1Z-5-020-611; → 1Z-58033645	246-082-008-025G	SWP-M-C	T1: 3
06.04 →	BCA	1Z-4-000 001 →; → 1Z-5-020 611; → 1Z-58033645	246-083-002-022G	SWP-D-C	T1: 3
06.04 →	BCA	1Z-4-000 001 →	246-086-001-007C	HLWP	T1: 3b

1.6 (75 kW | 1.6 Liter)

06.04 →	BGU	→ 1Z-5-020-611; → 1Z-58033645	246-082-008-025G	SWP-M-C	T1: 3
06.04 →	BGU	1Z-4-000 001 →; → 1Z-5-020 611; → 1Z-58033645	246-083-002-022G	SWP-D-C	T1: 3
06.04 →	BGU	1Z-4-000 001 →	246-086-001-007C	HLWP	T1: 3b

1.6 FSI (85 kW | 1.6 Liter)

06.04 →	BLF	→ 1Z-5-020-611; → 1Z-58033645	246-082-008-025G	SWP-M-C	T1: 3
06.04 →	BLF	1Z-4-000 001 →; → 1Z-5-020 611; → 1Z-58033645	246-083-002-022G	SWP-D-C	T1: 3
06.04 →	BLF	1Z-4-000 001 →	246-086-001-007C	HLWP	T1: 3b

2.0 FSI (110 kW | 2.0 Liter)

11.04 →	BLR / BLY	→ 1Z-5-020-611; → 1Z-58033645	246-082-008-025G	SWP-M-C	T1: 3
11.04 →	BLR / BLY	1Z-4-000 001 →; → 1Z-5-020 611; → 1Z-58033645	246-083-002-022G	SWP-D-C	T1: 3
11.04 →	BLR / BLY	1Z-4-000 001 →	246-086-001-007C	HLWP	T1: 3b

1.9 TDI (77 kW | 1.9 Liter)

06.04 →	BJB / BKC	→ 1Z-5-020-611; → 1Z-58033645	246-082-008-025G	SWP-M-C	T1: 3
06.04 →	BJB / BKC	1Z-4-000 001 →; → 1Z-5-020 611; → 1Z-58033645	246-083-002-022G	SWP-D-C	T1: 3
06.04 →	BJB / BKC	1Z-4-000 001 →	246-086-001-007C	HLWP	T1: 3b

2.0 TDI (103 kW | 2.0 Liter)

06.04 →	BKD	→ 1Z-5-020-611; → 1Z-58033645	246-082-008-025G	SWP-M-C	T1: 3
06.04 →	BKD	1Z-4-000 001 →; → 1Z-5-020 611; → 1Z-58033645	246-083-002-022G	SWP-D-C	T1: 3
06.04 →	BKD	1Z-4-000 001 →	246-086-001-007C	HLWP	T1: 3b



			VDO		
Datum	Motorcode	Fahrgestell Nr.	Artikel Nr.	Artikelbez.	Information

SKODA

OCTAVIA Combi (1Z5)

1.6 (75 kW 1.6 Liter)					
06.04 →	BGU	1Z-4-000 001 →	246-086-001-007C	HLWP	T1: 3b
1.6 FSI (85 kW 1.6 Liter)					
06.04 →	BLF	1Z-4-000 001 →	246-086-001-007C	HLWP	T1: 3b
2.0 FSI (110 kW 2.0 Liter)					
11.04 →	BLR / BLY	1Z-4-000 001 →	246-086-001-007C	HLWP	T1: 3b
2.0 FSI 4x4 (110 kW 2.0 Liter)					
11.04 →		1Z-4-000 001 →	246-086-001-007C	HLWP	T1: 3b
1.9 TDI (77 kW 1.9 Liter)					
06.04 →	BJB / BKC	1Z-4-000 001 →	246-086-001-007C	HLWP	T1: 3b
1.9 TDI 4x4 (77 kW 1.9 Liter)					
11.04 →		1Z-4-000 001 →	246-086-001-007C	HLWP	T1: 3b
2.0 TDI (103 kW 2.0 Liter)					
06.04 →	BKD	1Z-4-000 001 →	246-086-001-007C	HLWP	T1: 3b

SUPERB (3U4)

1.8 T (110 kW 1.8 Liter)					
02.02 →	AWT		246-082-008-025G	SWP-M-C	T1: 3
02.02 →	AWT		246-086-001-007C	HLWP	T1: 3b
2.0 (85 kW 2.0 Liter)					
02.02 →	AZM		246-082-008-025G	SWP-M-C	T1: 3
02.02 →	AZM		246-086-001-007C	HLWP	T1: 3b
2.8 V6 (142 kW 2.8 Liter)					
02.02 →	AMX		246-082-008-025G	SWP-M-C	T1: 3
02.02 →	AMX		246-086-001-007C	HLWP	T1: 3b
1.9 TDI (74 kW 1.9 Liter)					
08.02 →	AVB		246-082-008-025G	SWP-M-C	T1: 3
1.9 TDI (96 kW 1.9 Liter)					
02.02 →	AVF / AWX		246-082-008-025G	SWP-M-C	T1: 3
02.02 →	AVF / AWX		246-086-001-007C	HLWP	T1: 3b
2.5 TDI (114 kW 2.5 Liter)					
02.02 →	AYM		246-082-008-025G	SWP-M-C	T1: 3
02.02 →	AYM		246-086-001-007C	HLWP	T1: 3b
2.5 TDI (120 kW 2.5 Liter)					
06.03 →	BDG		246-082-008-025G	SWP-M-C	T1: 3
06.03 →	BDG		246-086-001-007C	HLWP	T1: 3b

SMART

CITY-COUPE (MC01)

0.6 (33 kW 0.6 Liter)					
07.98 → 01.04	M 160 E6AL B04		246-083-002-022G	SWP-D-C	T1: 3



			VDO		
Datum	Motorcode	Fahrgestell Nr.	Artikel Nr.	Artikelbez.	Information

SMART

CITY-COUPE (MC01)

0.6 (40 kW | 0.6 Liter)

07.98 → 01.04	M 160 E6AL B03		246-083-002-022G	SWP-D-C	T1: 3
---------------	----------------	--	------------------	---------	-------

0.6 (45 kW | 0.6 Liter)

01.01 → 01.04	M 160 E6AL B05		246-083-002-022G	SWP-D-C	T1: 3
---------------	----------------	--	------------------	---------	-------

0.8 CDI (30 kW | 0.8 Liter)

11.99 → 01.04	OM 660 DE 8LA		246-083-002-022G	SWP-D-C	T1: 3
---------------	---------------	--	------------------	---------	-------

CABRIO

0.6 (40 kW | 0.6 Liter)

03.00 → 01.04	M 160 E6AL B03		246-083-002-022G	SWP-D-C	T1: 3
---------------	----------------	--	------------------	---------	-------

0.6 (45 kW | 0.6 Liter)

01.01 → 01.04	M 160 E6AL B05		246-083-002-022G	SWP-D-C	T1: 3
---------------	----------------	--	------------------	---------	-------

0.8 CDI (30 kW | 0.8 Liter)

03.01 → 01.04	OM 660 DE 8LA		246-083-002-022G	SWP-D-C	T1: 3
---------------	---------------	--	------------------	---------	-------

VAUXHALL

AGILA

1.0 12V (43 kW | 1.0 Liter)

09.00 →	Z 10 XE		246-083-002-014G	SWP-D-C	T1: 6
---------	---------	--	------------------	---------	-------

1.2 16V (55 kW | 1.2 Liter)

09.00 →	Z 12 XE		246-083-002-014G	SWP-D-C	T1: 6
---------	---------	--	------------------	---------	-------

ASTRA Mk III CC

1.4 i (44 kW | 1.4 Liter)

10.91 → 12.96	C 14 NZ		246-083-001-004C	SWP-D-C	T1: 1
---------------	---------	--	------------------	---------	-------

1.4 S (55 kW | 1.4 Liter)

09.91 → 02.98	14 NV		246-083-001-004C	SWP-D-C	T1: 1
---------------	-------	--	------------------	---------	-------

1.4 i (60 kW | 1.4 Liter)

03.92 → 02.98	C 14 SE		246-083-001-004C	SWP-D-C	T1: 1
---------------	---------	--	------------------	---------	-------

1.4 i 16V (66 kW | 1.4 Liter)

02.96 → 02.98	X 14 XE		246-083-001-004C	SWP-D-C	T1: 1
---------------	---------	--	------------------	---------	-------

1.6 i (55 kW | 1.6 Liter)

09.91 → 02.98	C 16 NZ		246-083-001-004C	SWP-D-C	T1: 1
---------------	---------	--	------------------	---------	-------

1.6 i (74 kW | 1.6 Liter)

03.92 → 02.98	C 16 SE		246-083-001-004C	SWP-D-C	T1: 1
---------------	---------	--	------------------	---------	-------

1.6 i 16V (74 kW | 1.6 Liter)

08.94 → 02.98	X 16 XEL		246-083-001-004C	SWP-D-C	T1: 1
---------------	----------	--	------------------	---------	-------

1.8 i (66 kW | 1.8 Liter)

10.91 → 07.94	C 18 NZ		246-083-001-004C	SWP-D-C	T1: 1
---------------	---------	--	------------------	---------	-------



			VDO		
Datum	Motorcode	Fahrgestell Nr.	Artikel Nr.	Artikelbez.	Information

VAUXHALL**ASTRA Mk III CC**

1.8 i 16V (85 kW 1.8 Liter)					
09.94 → 02.98	C 18 XEL		246-083-001-004C	SWP-D-C	T1: 1
2.0 i (85 kW 2.0 Liter)					
10.91 → 07.93	C 20 NE		246-083-001-004C	SWP-D-C	T1: 1
2.0 i 16V (100 kW 2.0 Liter)					
04.95 → 02.98	X 20 XEV		246-083-001-004C	SWP-D-C	T1: 1
2.0 i 16V (110 kW 2.0 Liter)					
09.91 → 02.98	C 20 XE		246-083-001-004C	SWP-D-C	T1: 1
1.7 D (42 kW 1.7 Liter)					
12.91 → 02.98	17 D		246-083-001-004C	SWP-D-C	T1: 1
1.7 D (44 kW 1.7 Liter)					
10.91 → 08.94	17 DR		246-083-001-004C	SWP-D-C	T1: 1
1.7 TD (50 kW 1.7 Liter)					
11.94 → 02.98	X 17 DTL		246-083-001-004C	SWP-D-C	T1: 1
1.7 TD (60 kW 1.7 Liter)					
12.91 → 02.98	17 DT (TC4EE1)		246-083-001-004C	SWP-D-C	T1: 1

ASTRA Mk III

1.4 i (44 kW 1.4 Liter)					
09.91 → 03.98	C 14 NZ		246-082-008-014C	SWP-M-C	T1: 1
1.4 i (60 kW 1.4 Liter)					
03.92 → 03.98	C 14 SE		246-082-008-014C	SWP-M-C	T1: 1
1.6 i (52 kW 1.6 Liter)					
08.94 → 07.96	X 16 SZ		246-083-001-004C	SWP-D-C	T1: 1
1.6 i (74 kW 1.6 Liter)					
05.92 → 12.94	C 16 SE		246-082-008-014C	SWP-M-C	T1: 1
2.0 i (85 kW 2.0 Liter)					
03.92 → 03.98	C 20 NE		246-082-008-014C	SWP-M-C	T1: 1
1.7 D (42 kW 1.7 Liter)					
03.92 → 09.92	17 D		246-082-008-014C	SWP-M-C	T1: 1
1.7 TD (60 kW 1.7 Liter)					
12.91 → 03.98	17 DT (TC4EE1)		246-082-008-014C	SWP-M-C	T1: 1

ASTRA Mk III Estate

1.4 i (44 kW 1.4 Liter)					
09.91 → 12.96	C 14 NZ		246-083-001-004C	SWP-D-C	T1: 1
1.4 i (60 kW 1.4 Liter)					
09.91 → 02.98	C 14 SE		246-083-001-004C	SWP-D-C	T1: 1
1.4 i 16V (66 kW 1.4 Liter)					
02.96 → 01.98	X 14 XE		246-083-001-004C	SWP-D-C	T1: 1
1.6 i (52 kW 1.6 Liter)					
07.94 → 02.98	X 16 SZ		246-083-001-004C	SWP-D-C	T1: 1



			VDO		
Datum	Motorcode	Fahrgestell Nr.	Artikel Nr.	Artikelbez.	Information





VAUXHALL**ASTRA Mk III Estate**

1.6 i (55 kW 1.6 Liter)					
09.91 → 02.98	C 16 NZ / E 16 NZ		246-083-001-004C	SWP-D-C	T1: 1
1.6 i 16V (74 kW 1.6 Liter)					
08.94 → 02.98	X 16 XEL		246-083-001-004C	SWP-D-C	T1: 1
1.8 i (66 kW 1.8 Liter)					
10.91 → 07.94	C 18 NZ		246-083-001-004C	SWP-D-C	T1: 1
1.8 i 16V (85 kW 1.8 Liter)					
09.94 → 02.98	C 18 XEL		246-083-001-004C	SWP-D-C	T1: 1
2.0 i (85 kW 2.0 Liter)					
09.91 → 02.98	C 20 NE		246-083-001-004C	SWP-D-C	T1: 1
2.0 i 16V (100 kW 2.0 Liter)					
04.95 → 02.98	X 20 XEV		246-083-001-004C	SWP-D-C	T1: 1
1.7 D (42 kW 1.7 Liter)					
12.91 → 02.98	17 D		246-083-001-004C	SWP-D-C	T1: 1
1.7 D (44 kW 1.7 Liter)					
10.91 → 08.94	17 DR		246-083-001-004C	SWP-D-C	T1: 1
1.7 TD (60 kW 1.7 Liter)					
12.91 → 02.98	17 DT (TC4EE1)		246-083-001-004C	SWP-D-C	T1: 1
1.7 TD (50 kW 1.7 Liter)					
08.94 → 02.98	X 17 DTL		246-083-001-004C	SWP-D-C	T1: 1

ASTRA Mk IV CC

1.2 16V (48 kW 1.2 Liter)					
04.98 → 09.00	X 12 XE		246-083-002-014G	SWP-D-C	T1: 6
1.4 16V (66 kW 1.4 Liter)					
04.98 →	X 14 XE		246-083-002-014G	SWP-D-C	T1: 6
1.6 (55 kW 1.6 Liter)					
04.98 → 09.00	X 16 SZR		246-083-002-014G	SWP-D-C	T1: 6
1.6 16V (74 kW 1.6 Liter)					
04.98 →	X 16 XEL		246-083-002-014G	SWP-D-C	T1: 6
1.8 16V (85 kW 1.8 Liter)					
04.98 → 09.00	X 18 XE1		246-083-002-014G	SWP-D-C	T1: 6
2.0 16V (100 kW 2.0 Liter)					
04.98 →	X 20 XEV		246-083-002-014G	SWP-D-C	T1: 6
1.7 TD (50 kW 1.7 Liter)					
04.98 → 08.00	X 17 DTL		246-083-002-014G	SWP-D-C	T1: 6
2.0 DI (60 kW 2.0 Liter)					
04.98 →	X 20 DTL		246-083-002-014G	SWP-D-C	T1: 6
2.0 DTI 16V (74 kW 2.0 Liter)					
08.99 →	Y 20 DT		246-083-002-014G	SWP-D-C	T1: 6



			VDO		
Datum	Motorcode	Fahrgestell Nr.	Artikel Nr.	Artikelbez.	Information

VAUXHALL

ASTRA Mk IV Estate

1.4 16V (66 kW 1.4 Liter)					
04.98 →	X 14 XE		246-083-002-014G	SWP-D-C	T1: 6
1.6 (55 kW 1.6 Liter)					
04.98 → 09.00	X 16 SZR		246-083-002-014G	SWP-D-C	T1: 6
1.6 16V (74 kW 1.6 Liter)					
04.98 →	X 16 XEL		246-083-002-014G	SWP-D-C	T1: 6
1.8 16V (85 kW 1.8 Liter)					
04.98 → 09.00	X 18 XE1		246-083-002-014G	SWP-D-C	T1: 6
2.0 16V (100 kW 2.0 Liter)					
04.98 →	X 20 XEV		246-083-002-014G	SWP-D-C	T1: 6
1.7 TD (50 kW 1.7 Liter)					
04.98 → 08.00	X 17 DTL		246-083-002-014G	SWP-D-C	T1: 6
2.0 DI (60 kW 2.0 Liter)					
04.98 →	X 20 DTL		246-083-002-014G	SWP-D-C	T1: 6
2.0 DTI 16V (74 kW 2.0 Liter)					
08.99 →	Y 20 DTH		246-083-002-014G	SWP-D-C	T1: 6

CALIBRA

2.0 i (85 kW 2.0 Liter)					
06.90 → 08.96	C 20 NE		246-083-001-004C	SWP-D-C	T1: 1
2.0 i 16V (100 kW 2.0 Liter)					
02.94 → 06.97	X 20 XEV		246-083-001-004C	SWP-D-C	T1: 1
2.0 i 16V (110 kW 2.0 Liter)					
09.90 → 04.92	C 20 XE		246-083-001-004C	SWP-D-C	T1: 1
2.0 i Turbo 4x4 (150 kW 2.0 Liter)					
04.92 → 07.97	C 20 LET		246-083-001-004C	SWP-D-C	T1: 1
2.5 i V6 (125 kW 2.5 Liter)					
08.93 → 07.97	C 25 XE / X 25 XE		246-083-001-004C	SWP-D-C	T1: 1

CARLTON Mk III

1.8 (65 kW 1.8 Liter)					
09.87 → 09.90	E 18 NVR		246-082-008-014C	SWP-M-C	T1: 1
1.8 i (85 kW 1.8 Liter)					
11.86 → 08.92	18 SEH		246-082-008-014C	SWP-M-C	T1: 1
2.0 (73 kW 2.0 Liter)					
09.90 → 03.94	C 20 NEJ		246-082-008-014C	SWP-M-C	T1: 1
2.0 (85 kW 2.0 Liter)					
10.91 → 03.94	C 20 NE		246-082-008-014C	SWP-M-C	T1: 1
2.0 i (90 kW 2.0 Liter)					
11.86 → 09.90	20 SE		246-082-008-014C	SWP-M-C	T1: 1
2.6 i (110 kW 2.6 Liter)					
09.90 → 03.94	C 26 NE		246-082-008-014C	SWP-M-C	T1: 1



			VDO		
Datum	Motorcode	Fahrgestell Nr.	Artikel Nr.	Artikelbez.	Information

VAUXHALL**CARLTON Mk III****3.0 3000 (130 kW | 3.0 Liter)**

03.87 → 10.89 30 NE 246-082-008-014C SWP-M-C T1: 1

3.0 3000 24V (150 kW | 3.0 Liter)

10.89 → 08.93 C 30 SE 246-082-008-014C SWP-M-C T1: 1

3.6 24V Lotus (277 kW | 3.6 Liter)

09.90 → 09.92 C 36 GET 246-082-008-014C SWP-M-C T1: 1

2.3 D (54 kW | 2.3 Liter)

11.86 → 03.94 23 YD 246-082-008-014C SWP-M-C T1: 1

2.2 TD (66 kW | 2.2 Liter)

11.86 → 08.88 23 YDT 246-082-008-014C SWP-M-C T1: 1

2.3 TD Interc. (74 kW | 2.3 Liter)

09.88 → 03.94 23 DTR 246-082-008-014C SWP-M-C T1: 1

CARLTON Mk III Estate**1.8 (65 kW | 1.8 Liter)**

09.87 → 09.90 E 18 NVR 246-082-008-014C SWP-M-C T1: 1

1.8 i (85 kW | 1.8 Liter)

11.86 → 08.92 18 SEH 246-082-008-014C SWP-M-C T1: 1

2.6 i (110 kW | 2.6 Liter)

09.90 → 03.94 C 26 NE 246-082-008-014C SWP-M-C T1: 1

3.0 (130 kW | 3.0 Liter)

10.89 → 09.90 C 30 NE 246-082-008-014C SWP-M-C T1: 1

CAVALIER Mk II CC**1.8 i (82 kW | 1.8 Liter)**

01.85 → 07.88 18 SE 246-082-008-014C SWP-M-C T1: 1

1.8 i (85 kW | 1.8 Liter)

10.82 → 08.87 18 E 246-082-008-014C SWP-M-C T1: 1

2.0 i KAT (85 kW | 2.0 Liter)

04.87 → 08.88 C 20 NE 246-082-008-014C SWP-M-C T1: 1

CAVALIER Mk II**1.3 S (55 kW | 1.3 Liter)**

09.81 → 08.88 13 S 246-082-008-014C SWP-M-C T1: 1

1.6 S (66 kW | 1.6 Liter)

09.81 → 08.88 16 SH 246-082-008-014C SWP-M-C T1: 1

1.8 i (82 kW | 1.8 Liter)

01.85 → 07.88 18 SE 246-082-008-014C SWP-M-C T1: 1

1.8 i (85 kW | 1.8 Liter)

10.82 → 08.87 18 E 246-082-008-014C SWP-M-C T1: 1

2.0 i (85 kW | 2.0 Liter)

04.87 → 08.88 20 NE 246-082-008-014C SWP-M-C T1: 1



			VDO		
Datum	Motorcode	Fahrgestell Nr.	Artikel Nr.	Artikelbez.	Information

VAUXHALL

CAVALIER Mk II

2.0 i KAT (85 kW | 2.0 Liter)

09.86 → 08.88	C 20 NE		246-082-008-014C	SWP-M-C	T1: 1
---------------	---------	--	------------------	---------	-------

1.6 D (40 kW | 1.6 Liter)

09.82 → 08.88	16 D / 16 DA		246-082-008-014C	SWP-M-C	T1: 1
---------------	--------------	--	------------------	---------	-------

CAVALIER Mk II Estate

1.6 (66 kW | 1.6 Liter)

10.83 → 08.88	16 SH		246-082-008-014C	SWP-M-C	T1: 1
---------------	-------	--	------------------	---------	-------

1.6 D (40 kW | 1.6 Liter)

09.82 → 08.88	16 DA		246-082-008-014C	SWP-M-C	T1: 1
---------------	-------	--	------------------	---------	-------

CAVALIER Mk II Convertible

1800i (82 kW | 1.8 Liter)

11.85 → 08.88	18 SE		246-082-008-014C	SWP-M-C	T1: 1
---------------	-------	--	------------------	---------	-------

CAVALIER Mk III CC

1.8 i KAT (66 kW | 1.8 Liter)

09.90 → 10.95	C 18 NZ		246-083-001-004C	SWP-D-C	T1: 1
---------------	---------	--	------------------	---------	-------

2.0 i (85 kW | 2.0 Liter)

10.88 → 10.92	20 NE		246-083-001-004C	SWP-D-C	T1: 1
---------------	-------	--	------------------	---------	-------

2.0 SRi (95 kW | 2.0 Liter)

12.88 → 09.92	20 SEH		246-083-001-004C	SWP-D-C	T1: 1
---------------	--------	--	------------------	---------	-------

1.7 D (44 kW | 1.7 Liter)

09.92 → 10.95	17 DR		246-083-001-004C	SWP-D-C	T1: 1
---------------	-------	--	------------------	---------	-------

CAVALIER Mk III

1.4 S (55 kW | 1.4 Liter)

11.88 → 08.92	14 NV		246-082-008-014C	SWP-M-C	T1: 1
---------------	-------	--	------------------	---------	-------

11.88 → 08.92	14 NV		246-083-001-004C	SWP-D-C	T1: 1
---------------	-------	--	------------------	---------	-------

1.6 (60 kW | 1.6 Liter)

10.88 → 08.92	16 SV		246-082-008-014C	SWP-M-C	T1: 1
---------------	-------	--	------------------	---------	-------

10.88 → 08.92	16 SV		246-083-001-004C	SWP-D-C	T1: 1
---------------	-------	--	------------------	---------	-------

1.8 (66 kW | 1.8 Liter)

10.89 → 08.92	18 SV		246-082-008-014C	SWP-M-C	T1: 1
---------------	-------	--	------------------	---------	-------

10.89 → 08.92	18 SV / C 18 NZ		246-083-001-004C	SWP-D-C	T1: 1
---------------	-----------------	--	------------------	---------	-------

1.8 i KAT (66 kW | 1.8 Liter)

09.90 → 10.95	C 18 NZ		246-082-008-014C	SWP-M-C	T1: 1
---------------	---------	--	------------------	---------	-------

2.0 i (85 kW | 2.0 Liter)

10.88 → 10.90	20 NE		246-082-008-014C	SWP-M-C	T1: 1
---------------	-------	--	------------------	---------	-------

2.0 SRi (95 kW | 2.0 Liter)

12.88 → 09.92	20 SEH		246-082-008-014C	SWP-M-C	T1: 1
---------------	--------	--	------------------	---------	-------



			VDO		
Datum	Motorcode	Fahrgestell Nr.	Artikel Nr.	Artikelbez.	Information

VAUXHALL**CAVALIER Mk III****2.0 i 4x4 (95 kW | 2.0 Liter)**

12.88 → 08.92	20 SEH		246-082-008-014C	SWP-M-C	T1: 1
---------------	--------	--	------------------	---------	-------

2.0 i 16V (110 kW | 2.0 Liter)

10.89 → 11.95	C 20 XE		246-082-008-014C	SWP-M-C	T1: 1
---------------	---------	--	------------------	---------	-------

2.0 i 16V 4x4 (110 kW | 2.0 Liter)

10.89 → 10.92	C 20 XE		246-082-008-014C	SWP-M-C	T1: 1
---------------	---------	--	------------------	---------	-------

1.7 D (42 kW | 1.7 Liter)

11.88 → 09.92	17 D		246-082-008-014C	SWP-M-C	T1: 1
---------------	------	--	------------------	---------	-------

11.88 → 09.92	17 D		246-083-001-004C	SWP-D-C	T1: 1
---------------	------	--	------------------	---------	-------

1.7 TD (60 kW | 1.7 Liter)

09.91 → 10.95	17 DT (TC4EE1)		246-082-008-014C	SWP-M-C	T1: 1
---------------	----------------	--	------------------	---------	-------

COMBO**1.4 (44 kW | 1.4 Liter)**

07.94 → 09.01	C 14 NZ		246-083-001-004C	SWP-D-C	T1: 1; T11
---------------	---------	--	------------------	---------	------------

1.7 D (44 kW | 1.7 Liter)

07.94 → 09.01	17 D (4EE1) / X 17 D (4EE1)		246-083-001-004C	SWP-D-C	T1: 1; T11
---------------	-----------------------------	--	------------------	---------	------------

CORSA**1.0 i 12V (40 kW | 1.0 Liter)**

04.97 → 09.00	X 10 XE		246-083-001-004C	SWP-D-C	T1: 1; T11
---------------	---------	--	------------------	---------	------------

08.97 → 09.00	X 10 XE		246-083-002-014G	SWP-D-C	T1: 6; T10
---------------	---------	--	------------------	---------	------------

1.2 i (33 kW | 1.2 Liter)

04.93 → 08.98	C 12 NZ / X 12 SZ		246-083-001-004C	SWP-D-C	T1: 1; T11
---------------	-------------------	--	------------------	---------	------------

01.96 → 08.98	C 12 NZ	T3000001 →; T4000001 →; T6000001 →	246-083-002-014G	SWP-D-C	T1: 6; T10
---------------	---------	------------------------------------------	------------------	---------	------------

1.2 i 16V (48 kW | 1.2 Liter)

03.98 → 09.00	X 12 XE		246-083-001-004C	SWP-D-C	T1: 1; T11
---------------	---------	--	------------------	---------	------------

03.98 → 09.00	X 12 XE		246-083-002-014G	SWP-D-C	T1: 6; T10
---------------	---------	--	------------------	---------	------------

1.4 i (44 kW | 1.4 Liter)

04.93 → 08.98	C 14 NZ / X 14 SZ		246-083-001-004C	SWP-D-C	T1: 1; T11
---------------	-------------------	--	------------------	---------	------------

01.96 → 08.98	C 14 NZ	T3000001 →; T4000001 →; T6000001 →	246-083-002-014G	SWP-D-C	T1: 6; T10
---------------	---------	------------------------------------------	------------------	---------	------------

1.4 i 16V (66 kW | 1.4 Liter)

09.94 → 09.00	X 14 XE		246-083-001-004C	SWP-D-C	T1: 1; T11
---------------	---------	--	------------------	---------	------------

01.96 → 09.00	X 14 XE	T3000001 →; T4000001 →; T6000001 →	246-083-002-014G	SWP-D-C	T1: 6; T10
---------------	---------	------------------------------------------	------------------	---------	------------

1.6 i 16V (78 kW | 1.6 Liter)

04.97 → 09.00	X 16 XE		246-083-001-004C	SWP-D-C	T1: 1; T11
---------------	---------	--	------------------	---------	------------

04.97 → 09.00	X 16 XE		246-083-002-014G	SWP-D-C	T1: 6; T10
---------------	---------	--	------------------	---------	------------



			VDO		
Datum	Motorcode	Fahrgestell Nr.	Artikel Nr.	Artikelbez.	Information

VAUXHALL**CORSA**

1.6 GSI 16V (80 kW 1.6 Liter)					
08.93 → 06.95	C 16 XE		246-083-001-004C	SWP-D-C	T1: 1; T11
1.5 D (37 kW 1.5 Liter)					
04.93 → 02.96	15 D (4EC1)		246-083-001-004C	SWP-D-C	T1: 1; T11
1.5 TD (49 kW 1.5 Liter)					
04.93 → 10.96	15 DT (T4EC1) / X 15 DT (T4EC1)		246-083-001-004C	SWP-D-C	T1: 1; T11
02.96 → 10.96	15 DT (T4EC1) / X 15 DT (T4EC1)	T3000001 →; T4000001 →; T6000001 →	246-083-002-014G	SWP-D-C	T1: 6; T10
1.7 D (44 kW 1.7 Liter)					
02.96 → 09.00	17 D (4EE1) / X 17 D (4EE1)		246-083-001-004C	SWP-D-C	T1: 1; T11
02.96 → 09.00	17 D (4EE1) / X 17 D (4EE1)	T3000001 →; T4000001 →; T6000001 →	246-083-002-014G	SWP-D-C	T1: 6; T10

NOVA CC

1.0 (33 kW 1.0 Liter)					
05.83 → 03.92	10 S		246-082-008-014C	SWP-M-C	T1: 1
1.2 i KAT (33 kW 1.2 Liter)					
02.92 → 03.93	C 12 NZ		246-082-008-014C	SWP-M-C	T1: 1
1.2 N (38 kW 1.2 Liter)					
05.90 → 03.93	12 NV		246-082-008-014C	SWP-M-C	T1: 1
1.2 S (40 kW 1.2 Liter)					
05.83 → 02.90	12 ST		246-082-008-014C	SWP-M-C	T1: 1
1.3 S (51 kW 1.3 Liter)					
07.83 → 09.89	13 SB		246-082-008-014C	SWP-M-C	T1: 1
1.4 i (44 kW 1.4 Liter)					
08.90 → 03.93	C 14 NZ		246-082-008-014C	SWP-M-C	T1: 1
1.4 S (55 kW 1.4 Liter)					
01.90 → 01.92	14 NV		246-082-008-014C	SWP-M-C	T1: 1
1.6 GSI (72 kW 1.6 Liter)					
02.92 → 03.93	C 16 SEI		246-082-008-014C	SWP-M-C	T1: 1
1.6 GSI (74 kW 1.6 Liter)					
05.88 → 01.92	E 16 SE		246-082-008-014C	SWP-M-C	T1: 1
1.5 D (37 kW 1.5 Liter)					
09.91 → 03.93	15 D (4EC1)		246-082-008-014C	SWP-M-C	T1: 1
1.5 TD (49 kW 1.5 Liter)					
01.90 → 03.93	15 DT (T4EC1)		246-082-008-014C	SWP-M-C	T1: 1

NOVA

1.0 (33 kW 1.0 Liter)					
04.83 → 10.87	10 S		246-082-008-014C	SWP-M-C	T1: 1



			VDO		
Datum	Motorcode	Fahrgestell Nr.	Artikel Nr.	Artikelbez.	Information

VAUXHALL**NOVA****1.2 N (33 kW | 1.2 Liter)**

01.85 → 10.87 | 12 NC / E 12 GV | | 246-082-008-014C | SWP-M-C | T1: 1

1.2 S (40 kW | 1.2 Liter)

04.83 → 10.87 | 12 ST | | 246-082-008-014C | SWP-M-C | T1: 1

1.3 i (44 kW | 1.3 Liter)

09.85 → 10.87 | 13 NB | | 246-082-008-014C | SWP-M-C | T1: 1

1.4 S (55 kW | 1.4 Liter)

08.90 → 10.92 | 14 NV | | 246-082-008-014C | SWP-M-C | T1: 1

OMEGA**2.0 (85 kW | 2.0 Liter)**

04.94 → 10.95 | X 20 SE | | 246-082-008-014C | SWP-M-C | T1: 1

2.0 16V (100 kW | 2.0 Liter)

04.94 → 09.99 | X 20 XEV | → X1999999 | 246-082-008-014C | SWP-M-C | T1: 1

2.5 V6 (125 kW | 2.5 Liter)

04.94 → 12.99 | X 25 XE | → X1999999 | 246-082-008-014C | SWP-M-C | T1: 1

01.00 → 09.00 | X 25 XE | Y1000001 → | 246-082-008-021G | SWP-M-C | T1: 6

3.0 V6 (155 kW | 3.0 Liter)

06.94 → 12.99 | X 30 XE | → X1999999 | 246-082-008-014C | SWP-M-C | T1: 1

01.00 → | X 30 XE | Y1000001 → | 246-082-008-021G | SWP-M-C | T1: 6

2.0 DTI 16V (74 kW | 2.0 Liter)

10.98 → 12.99 | X 20 DTH | → X1999999 | 246-082-008-014C | SWP-M-C | T1: 1

01.00 → 09.00 | X 20 DTH | Y1000001 → | 246-082-008-021G | SWP-M-C | T1: 6

2.5 TD (96 kW | 2.5 Liter)

04.94 → 12.99 | 25 DT / X 25 DT | → X1999999 | 246-082-008-014C | SWP-M-C | T1: 1

01.00 → 02.01 | 25 DT / X 25 DT | Y1000001 → | 246-082-008-021G | SWP-M-C | T1: 6

OMEGA Estate**2.0 (85 kW | 2.0 Liter)**

04.94 → 10.95 | X 20 SE | | 246-083-001-004C | SWP-D-C | T1: 1

2.0 16V (100 kW | 2.0 Liter)

04.94 → 09.99 | X 20 XEV | → X1999999 | 246-083-001-004C | SWP-D-C | T1: 1

2.5 V6 (125 kW | 2.5 Liter)

04.94 → 12.99 | X 25 XE | → X1999999 | 246-083-001-004C | SWP-D-C | T1: 1

01.00 → 09.00 | X 25 XE | Y1000001 → | 246-083-002-014G | SWP-D-C | T1: 6

3.0 V6 (155 kW | 3.0 Liter)

06.96 → 12.99 | X 30 XE | → X1999999 | 246-083-001-004C | SWP-D-C | T1: 1

01.00 → | X 30 XE | Y1000001 → | 246-083-002-014G | SWP-D-C | T1: 6

2.5 TD (96 kW | 2.5 Liter)

01.97 → 12.99 | 25 DT / X 25 DT | → X1999999 | 246-083-001-004C | SWP-D-C | T1: 1

01.00 → 02.01 | 25 DT / X 25 DT | Y1000001 → | 246-083-002-014G | SWP-D-C | T1: 6



			VDO		
Datum	Motorcode	Fahrgestell Nr.	Artikel Nr.	Artikelbez.	Information

VAUXHALL**SENATOR Mk II**

2.5 i (103 kW 2.5 Liter)					
09.87 → 09.90	25 E		246-082-008-014C	SWP-M-C	T1: 1
2.6 i (110 kW 2.6 Liter)					
09.90 → 08.93	C 26 NE		246-082-008-014C	SWP-M-C	T1: 1
3.0 (115 kW 3.0 Liter)					
09.90 → 10.92	C 30 LE		246-082-008-014C	SWP-M-C	T1: 1
3.0 (130 kW 3.0 Liter)					
01.88 → 08.90	30 NE		246-082-008-014C	SWP-M-C	T1: 1
3.0 i KAT (130 kW 3.0 Liter)					
09.90 → 10.92	C 30 NE		246-082-008-014C	SWP-M-C	T1: 1
3.0 24V (150 kW 3.0 Liter)					
10.89 → 08.93	C 30 SE		246-082-008-014C	SWP-M-C	T1: 1

TIGRA

1.4 16V (66 kW 1.4 Liter)					
11.94 →	X 14 XE		246-083-001-004C	SWP-D-C	T1: 1; T11
1.6 16V (78 kW 1.6 Liter)					
11.94 →	X 16 XE		246-083-001-004C	SWP-D-C	T1: 1; T11





VECTRA CC

1.6 i (55 kW 1.6 Liter)					
10.95 →	X 16 SZR		246-082-008-021G	SWP-M-C	T1: 6
1.6 i 16V (74 kW 1.6 Liter)					
10.95 →	X 16 XEL		246-082-008-021G	SWP-M-C	T1: 6
1.8 i 16V (85 kW 1.8 Liter)					
10.95 → 09.00	X 18 XE / X 18 XE1		246-082-008-021G	SWP-M-C	T1: 6
2.0 i 16V (100 kW 2.0 Liter)					
10.95 → 09.00	X 20 XEV		246-082-008-021G	SWP-M-C	T1: 6
2.5 i V6 (125 kW 2.5 Liter)					
10.95 → 09.00	X 25 XE		246-082-008-021G	SWP-M-C	T1: 6
1.7 TD (60 kW 1.7 Liter)					
10.95 → 07.96	X 17 DT (TC4EE1)		246-082-008-021G	SWP-M-C	T1: 6
2.0 Di 16V (60 kW 2.0 Liter)					
11.96 →	X 20 DTL		246-082-008-021G	SWP-M-C	T1: 6

VECTRA

1.6 i (55 kW 1.6 Liter)					
10.95 →	X 16 SZR		246-082-008-021G	SWP-M-C	T1: 6
1.6 i 16V (74 kW 1.6 Liter)					
10.95 →	X 16 XEL		246-082-008-021G	SWP-M-C	T1: 6
1.8 i 16V (85 kW 1.8 Liter)					
10.95 → 09.00	X 18 XE / X 18 XE1		246-082-008-021G	SWP-M-C	T1: 6



			VDO		
Datum	Motorcode	Fahrgestell Nr.	Artikel Nr.	Artikelbez.	Information

VAUXHALL

VECTRA

2.0 i 16V (100 kW | 2.0 Liter)

10.95 → 09.00	X 20 XEV		246-082-008-021G	SWP-M-C	T1: 6
---------------	----------	--	------------------	---------	-------

2.5 i V6 (125 kW | 2.5 Liter)

10.95 → 09.00	X 25 XE		246-082-008-021G	SWP-M-C	T1: 6
---------------	---------	--	------------------	---------	-------

1.7 TD (60 kW | 1.7 Liter)

10.95 → 07.96	X 17 DT (TC4EE1)		246-082-008-021G	SWP-M-C	T1: 6
---------------	------------------	--	------------------	---------	-------

2.0 DI 16V (60 kW | 2.0 Liter)

11.96 →	X 20 DTL		246-082-008-021G	SWP-M-C	T1: 6
---------	----------	--	------------------	---------	-------

VECTRA Estate

1.8 i 16V (85 kW | 1.8 Liter)

11.96 → 09.00	X 18 XE / X 18 XE1		246-083-002-014G	SWP-D-C	T1: 6
---------------	--------------------	--	------------------	---------	-------

2.0 i 16V (100 kW | 2.0 Liter)

11.96 → 09.00	X 20 XEV		246-083-002-014G	SWP-D-C	T1: 6
---------------	----------	--	------------------	---------	-------

2.5 i V6 (125 kW | 2.5 Liter)

11.96 → 09.00	X 25 XE		246-083-002-014G	SWP-D-C	T1: 6
---------------	---------	--	------------------	---------	-------

2.0 DI 16V (60 kW | 2.0 Liter)

11.96 →	X 20 DTL		246-083-002-014G	SWP-D-C	T1: 6
---------	----------	--	------------------	---------	-------

ZAFIRA

1.6 16V (74 kW | 1.6 Liter)

05.99 →	X 16 XEL		246-083-002-014G	SWP-D-C	T1: 6
---------	----------	--	------------------	---------	-------

1.8 16V (85 kW | 1.8 Liter)

05.99 → 09.00	X 18 XE1		246-083-002-014G	SWP-D-C	T1: 6
---------------	----------	--	------------------	---------	-------

2.0 DI 16V (60 kW | 2.0 Liter)

10.99 →	X 20 DTL		246-083-002-014G	SWP-D-C	T1: 6
---------	----------	--	------------------	---------	-------

VOLVO

S70

2.0 (93 kW | 2.0 Liter)

01.97 → 11.00	B 5202 S		246-075-044-002A	SWP-M-G	T1: 2; T8
---------------	----------	--	------------------	---------	-----------

2.0 (105 kW | 2.0 Liter)

01.97 → 11.00	B 5204 F		246-075-044-002A	SWP-M-G	T1: 2; T8
---------------	----------	--	------------------	---------	-----------

2.0 (132 kW | 2.0 Liter)

01.97 → 11.00	B 5204 T2		246-075-044-002A	SWP-M-G	T1: 2; T8
---------------	-----------	--	------------------	---------	-----------

2.0 Turbo (155 kW | 2.0 Liter)

01.97 → 11.00	B 5204 T		246-075-044-002A	SWP-M-G	T1: 2; T8
---------------	----------	--	------------------	---------	-----------

2.0 Turbo (166 kW | 2.0 Liter)

01.97 → 11.00	B 5204 T3		246-075-044-002A	SWP-M-G	T1: 2; T8
---------------	-----------	--	------------------	---------	-----------



			VDO		
Datum	Motorcode	Fahrgestell Nr.	Artikel Nr.	Artikelbez.	Information

VOLVO**S70**

2.3 T-5 (176 kW 2.3 Liter)					
01.97 → 11.00	B 5234 T3		246-075-044-002A	SWP-M-G	T1: 2; T8
2.3 Turbo (184 kW 2.3 Liter)					
01.97 → 11.00	B 5234 FT+		246-075-044-002A	SWP-M-G	T1: 2; T8
2.4 (103 kW 2.4 Liter)					
08.99 → 11.00			246-075-044-002A	SWP-M-G	T1: 2; T8
2.5 Bifuel (103 kW 2.5 Liter)					
07.99 → 11.00	B 5244 SG		246-075-044-002A	SWP-M-G	T1: 2; T8
2.5 (106 kW 2.5 Liter)					
01.97 → 11.00	B 5252 S		246-075-044-002A	SWP-M-G	T1: 2; T8
2.5 Bifuel (106 kW 2.5 Liter)					
10.98 → 11.00	GB 5252 S		246-075-044-002A	SWP-M-G	T1: 2; T8
2.5 (121 kW 2.5 Liter)					
06.98 → 11.00			246-075-044-002A	SWP-M-G	T1: 2; T8
2.4 (125 kW 2.4 Liter)					
01.97 → 11.00	B 5254 S		246-075-044-002A	SWP-M-G	T1: 2; T8
2.4 Turbo (142 kW 2.4 Liter)					
01.97 → 11.00	B 5244 T / B 5254 T		246-075-044-002A	SWP-M-G	T1: 2; T8
2.5 TDI (103 kW 2.5 Liter)					
01.97 → 11.00	D 5252 T		246-075-044-002A	SWP-M-G	T1: 2; T8





V70 I Kombi

2.0 (93 kW 2.0 Liter)					
01.97 → 03.00	B 5202 S		246-075-044-002A	SWP-M-G	T1: 2
2.3 T-5 AWD (176 kW 2.3 Liter)					
01.97 → 03.00	B 5234 T3		246-075-044-002A	SWP-M-G	T1: 2
2.3 T AWD (184 kW 2.3 Liter)					
05.97 → 03.00	B 5234 FT+		246-075-044-002A	SWP-M-G	T1: 2
2.4 (103 kW 2.4 Liter)					
08.99 → 05.00			246-075-044-002A	SWP-M-G	T1: 2
2.5 Bifuel (106 kW 2.5 Liter)					
10.98 → 08.99	GB 5252 S		246-075-044-002A	SWP-M-G	T1: 2
2.5 (121 kW 2.5 Liter)					
06.98 → 03.00			246-075-044-002A	SWP-M-G	T1: 2
2.4 Turbo (142 kW 2.4 Liter)					
01.97 → 03.00	B 5244 T / B 5254 T		246-075-044-002A	SWP-M-G	T1: 2
2.5 TDI (103 kW 2.5 Liter)					
01.97 → 05.00	D 5252 T		246-075-044-002A	SWP-M-G	T1: 2

140 (142, 144)

2.0 S (85 kW 2.0 Liter)					
01.74 → 08.75	B 20 F		246-075-051-003C	SWP-M-G	T1: 2; T2: F



			VDO		
Datum	Motorcode	Fahrgestell Nr.	Artikel Nr.	Artikelbez.	Information

VOLVO**140 (142, 144)****2.0 (91 kW | 2.0 Liter)**

01.74 → 04.75	B 20 E		246-075-051-003C	SWP-M-G	T1: 2; T2: F
---------------	--------	--	------------------	---------	--------------

240 (P242, P244)**2.0 (60 kW | 2.0 Liter)**

08.74 → 07.76	B 20 A		246-075-051-003C	SWP-M-G	T1: 2; T2: F
---------------	--------	--	------------------	---------	--------------

2.0 (66 kW | 2.0 Liter)

09.76 → 07.79	B 19 A		246-075-051-003C	SWP-M-G	T1: 2; T2: F
---------------	--------	--	------------------	---------	--------------

2.0 (71 kW | 2.0 Liter)

03.79 → 08.82	B 19 A		246-075-051-003C	SWP-M-G	T1: 2; T2: F
---------------	--------	--	------------------	---------	--------------

2.0 (76 kW | 2.0 Liter)

08.84 → 06.85	B 200 K		246-075-051-003C	SWP-M-G	T1: 2; T2: F
---------------	---------	--	------------------	---------	--------------

2.1 (71 kW | 2.1 Liter)

08.74 → 07.75	B 21 A		246-075-051-003C	SWP-M-G	T1: 2; T2: F
---------------	--------	--	------------------	---------	--------------

2.1 (90 kW | 2.1 Liter)

08.74 → 02.79	B 21 E		246-075-051-003C	SWP-M-G	T1: 2; T2: F
---------------	--------	--	------------------	---------	--------------

2.3 i KAT (85 kW | 2.3 Liter)

08.88 → 07.93	B 230 F		246-075-051-003C	SWP-M-G	T1: 2; T2: F
---------------	---------	--	------------------	---------	--------------

2.3 (96 kW | 2.3 Liter)

08.83 → 06.85	B 230 E		246-075-051-003C	SWP-M-G	T1: 2; T2: F
---------------	---------	--	------------------	---------	--------------

2.3 (98 kW | 2.3 Liter)

08.88 → 12.89	B 23 E		246-075-051-003C	SWP-M-G	T1: 2; T2: F
---------------	--------	--	------------------	---------	--------------

2.3 (100 kW | 2.3 Liter)

08.80 → 08.82	B 23 E		246-075-051-003C	SWP-M-G	T1: 2; T2: F
---------------	--------	--	------------------	---------	--------------

2.3 (103 kW | 2.3 Liter)

03.79 → 07.79	B 23 E		246-075-051-003C	SWP-M-G	T1: 2; T2: F
---------------	--------	--	------------------	---------	--------------

2.4 Diesel (58 kW | 2.4 Liter)

08.87 → 12.88	D 24		246-075-051-003C	SWP-M-G	T1: 2; T2: F
---------------	------	--	------------------	---------	--------------

2.4 Diesel (60 kW | 2.4 Liter)

03.79 → 06.85	D 24		246-075-051-003C	SWP-M-G	T1: 2; T2: F
---------------	------	--	------------------	---------	--------------

240 Kombi (P245)**2.0 (71 kW | 2.0 Liter)**

07.81 → 08.82	B 19 A		246-075-051-003C	SWP-M-G	T1: 2; T2: F
---------------	--------	--	------------------	---------	--------------

2.0 (76 kW | 2.0 Liter)

08.84 → 07.85	B 200 K		246-075-051-003C	SWP-M-G	T1: 2; T2: F
---------------	---------	--	------------------	---------	--------------

2.1 Turbo (114 kW | 2.1 Liter)

07.81 → 06.85	B 21 ET		246-075-051-003C	SWP-M-G	T1: 2; T2: F
---------------	---------	--	------------------	---------	--------------

2.3 i KAT (85 kW | 2.3 Liter)

08.88 → 07.93	B 230 F		246-075-051-003C	SWP-M-G	T1: 2; T2: F
---------------	---------	--	------------------	---------	--------------

2.3 (96 kW | 2.3 Liter)

08.84 → 06.85	B 230 E		246-075-051-003C	SWP-M-G	T1: 2; T2: F
---------------	---------	--	------------------	---------	--------------



			VDO		
Datum	Motorcode	Fahrgestell Nr.	Artikel Nr.	Artikelbez.	Information

VOLVO**240 Kombi (P245)**

2.3 (98 kW 2.3 Liter)					
08.88 → 12.88	B 23 E		246-075-051-003C	SWP-M-G	T1: 2; T2: F
2.7 GLT6 (104 kW 2.7 Liter)					
08.79 → 07.80	B 27 E		246-075-051-003C	SWP-M-G	T1: 2; T2: F
2.4 Diesel (58 kW 2.4 Liter)					
08.88 → 08.93	D 24		246-075-051-003C	SWP-M-G	T1: 2; T2: F
2.4 Diesel (60 kW 2.4 Liter)					
07.79 → 08.82	D 24		246-075-051-003C	SWP-M-G	T1: 2; T2: F

260 (P262, P264)

2.7 (92 kW 2.7 Liter)					
08.76 → 07.82	B 27 A	B028320 →	246-075-051-003C	SWP-M-G	T1: 2; T2: F
2.7 (103 kW 2.7 Liter)					
08.74 → 07.80	B 27 E	B028320 →	246-075-051-003C	SWP-M-G	T1: 2; T2: F
2.7 (109 kW 2.7 Liter)					
08.78 → 07.82	B 27 E	B028320 →	246-075-051-003C	SWP-M-G	T1: 2; T2: F
2.8 (95 kW 2.8 Liter)					
08.80 → 07.82	B 28 A	B028320 →	246-075-051-003C	SWP-M-G	T1: 2; T2: F
2.8 (114 kW 2.8 Liter)					
08.80 → 07.82	B 28 E	B028320 →	246-075-051-003C	SWP-M-G	T1: 2; T2: F





260 Kombi (P265)

2.7 (103 kW 2.7 Liter)					
08.78 → 07.80	B 27 E		246-075-051-003C	SWP-M-G	T1: 2; T2: F
2.7 (109 kW 2.7 Liter)					
10.78 → 07.79	B 27 F		246-075-051-003C	SWP-M-G	T1: 2; T2: F
2.8 (114 kW 2.8 Liter)					
08.80 → 07.82	B 28 F	B028320 →	246-075-051-003C	SWP-M-G	T1: 2; T2: F

340-360 (343, 345)

1.4 (46 kW 1.4 Liter)					
08.82 → 08.85	B 14.3 E		246-075-023-004C	SWP-M-G	T1: 1; T2: D; T7: 343
1.4 (47 kW 1.4 Liter)					
08.79 → 07.83	B 14.3 E		246-075-023-004C	SWP-M-G	T1: 1; T2: D; T7: 343
1.4 (50 kW 1.4 Liter)					
08.86 → 12.88	B 14.4 S		246-075-023-004C	SWP-M-G	T1: 1; T2: D; T7: 343
1.4 (51 kW 1.4 Liter)					
08.75 → 07.83	B 14.4 S		246-075-023-004C	SWP-M-G	T1: 1; T2: D; T7: 343
1.4 (51 kW 1.4 Liter)					
08.87 → 07.88	B 14.4 S		246-075-023-004C	SWP-M-G	T1: 1; T2: D; T7: 343
1.4 (52 kW 1.4 Liter)					
08.83 → 07.86	B 14.4 S		246-075-023-004C	SWP-M-G	T1: 1; T2: D; T7: 343



			VDO		
Datum	Motorcode	Fahrgestell Nr.	Artikel Nr.	Artikelbez.	Information

VOLVO**340-360 (343, 345)**

1.7 (59 kW 1.7 Liter)					
08.85 → 07.91	B 17 2 K		246-075-023-004C	SWP-M-G	T1: 1; T2: D; T7: 343
2.0 (65 kW 2.0 Liter)					
08.80 → 07.84	B 19 A		246-075-023-004C	SWP-M-G	T1: 1; T2: D; T7: 343
2.0 (68 kW 2.0 Liter)					
08.83 → 07.84	B 19 A		246-075-023-004C	SWP-M-G	T1: 1; T2: D; T7: 343
2.0 (70 kW 2.0 Liter)					
08.80 → 07.83	B 19 A / B 200 K		246-075-023-004C	SWP-M-G	T1: 1; T2: D; T7: 343
09.81 → 07.83	B 19 A / B 200 K	CC 610 000 →	246-075-042-001C	SWP-M-G	T1: 1
2.0 (77 kW 2.0 Liter)					
08.84 → 07.87	B 200 K		246-075-023-004C	SWP-M-G	T1: 1; T2: D; T7: 343
2.0 (80 kW 2.0 Liter)					
08.88 → 07.89	B 200 F		246-075-023-004C	SWP-M-G	T1: 1; T2: D; T7: 343
2.0 (81 kW 2.0 Liter)					
08.87 → 07.88	B 200 F		246-075-023-004C	SWP-M-G	T1: 1; T2: D; T7: 343
2.0 (82 kW 2.0 Liter)					
08.86 → 07.88	B 200 E / B 200 F		246-075-023-004C	SWP-M-G	T1: 1; T2: D; T7: 343
2.0 (83 kW 2.0 Liter)					
08.82 → 07.84	B 19 E		246-075-023-004C	SWP-M-G	T1: 1; T2: D; T7: 343
2.0 (85 kW 2.0 Liter)					
08.82 → 07.84	B 19 E		246-075-023-004C	SWP-M-G	T1: 1; T2: D; T7: 343
2.0 (87 kW 2.0 Liter)					
08.84 → 07.86	B 200 E		246-075-023-004C	SWP-M-G	T1: 1; T2: D; T7: 343
2.1 (90 kW 2.1 Liter)					
08.81 → 07.82	B 21 E		246-075-023-004C	SWP-M-G	T1: 1; T2: D; T7: 343
1.6 Diesel (40 kW 1.6 Liter)					
08.84 → 07.91	D 16		246-075-023-004C	SWP-M-G	T1: 1; T2: D; T7: 343

740 (744)

2.0 (89 kW 2.0 Liter)					
08.85 → 07.91	B 200 G		246-075-044-001C	SWP-M-G	T1: 2
2.3 (83 kW 2.3 Liter)					
09.85 → 12.89	B 230 F		246-075-044-001C	SWP-M-G	T1: 2
2.3 (96 kW 2.3 Liter)					
08.84 → 07.88	B 230 E		246-075-044-001C	SWP-M-G	T1: 2
2.3 (114 kW 2.3 Liter)					
08.88 → 07.90	B 234 F		246-075-044-001C	SWP-M-G	T1: 2
2.3 Turbo (115 kW 2.3 Liter)					
07.88 → 07.89	B 230 FT		246-075-044-001C	SWP-M-G	T1: 2
2.3 Turbo (121 kW 2.3 Liter)					
08.89 → 07.90	B 230 FT		246-075-044-001C	SWP-M-G	T1: 2
2.4 Diesel (60 kW 2.4 Liter)					
08.84 → 07.92	D 24		246-075-044-001C	SWP-M-G	T1: 2



			VDO		
Datum	Motorcode	Fahrgestell Nr.	Artikel Nr.	Artikelbez.	Information

VOLVO**740 (744)****2.4 TD (83 kW | 2.4 Liter)**

07.85 → 07.90			246-075-044-001C	SWP-M-G	T1: 2
---------------	--	--	------------------	---------	-------

740 Kombi (745)**2.0 (82 kW | 2.0 Liter)**

08.89 → 07.91	B 200 F		246-075-044-001C	SWP-M-G	T1: 2
08.89 → 07.91	B 200 F		246-075-044-002A	SWP-M-G	T1: 2

2.0 (89 kW | 2.0 Liter)

08.85 → 07.92	B 200 G		246-075-044-001C	SWP-M-G	T1: 2
08.85 → 07.92	B 200 G		246-075-044-002A	SWP-M-G	T1: 2

2.3 (83 kW | 2.3 Liter)

08.85 → 12.89	B 230 F		246-075-044-001C	SWP-M-G	T1: 2
08.85 → 12.89	B 230 F		246-075-044-002A	SWP-M-G	T1: 2

2.3 (96 kW | 2.3 Liter)

08.85 → 07.88	B 230 E		246-075-044-001C	SWP-M-G	T1: 2
08.85 → 07.88	B 230 E		246-075-044-002A	SWP-M-G	T1: 2

2.3 (114 kW | 2.3 Liter)

08.88 → 07.90	B 234 F		246-075-044-001C	SWP-M-G	T1: 2
08.88 → 07.90	B 234 F		246-075-044-002A	SWP-M-G	T1: 2

2.3 Turbo (115 kW | 2.3 Liter)

08.86 → 07.89	B 230 FT		246-075-044-001C	SWP-M-G	T1: 2
08.86 → 07.89	B 230 FT		246-075-044-002A	SWP-M-G	T1: 2

2.3 Turbo (121 kW | 2.3 Liter)

08.89 → 07.90	B 230 FT / B 230 GT		246-075-044-001C	SWP-M-G	T1: 2
08.89 → 07.90	B 230 FT / B 230 GT		246-075-044-002A	SWP-M-G	T1: 2

2.3 Turbo (134 kW | 2.3 Liter)

08.85 → 07.88	B 230 ET		246-075-044-001C	SWP-M-G	T1: 2
08.85 → 07.88	B 230 ET		246-075-044-002A	SWP-M-G	T1: 2

2.4 Diesel (60 kW | 2.4 Liter)

08.85 → 07.88	D 24		246-075-044-001C	SWP-M-G	T1: 2
08.85 → 07.88	D 24		246-075-044-002A	SWP-M-G	T1: 2

2.4 Turbo-Diesel (80 kW | 2.4 Liter)

09.85 → 07.92	D 24 T		246-075-044-001C	SWP-M-G	T1: 2
09.85 → 07.92	D 24 T		246-075-044-002A	SWP-M-G	T1: 2

2.4 TD Interc. (90 kW | 2.4 Liter)

08.86 → 07.88	D 24 TIC		246-075-044-001C	SWP-M-G	T1: 2
07.87 → 07.88	D 24 TIC		246-075-044-002A	SWP-M-G	T1: 2

760 (704, 764)**2.3 Turbo (704) (134 kW | 2.3 Liter)**

08.84 → 06.85	B 230 ET		246-075-044-001C	SWP-M-G	T1: 2
---------------	----------	--	------------------	---------	-------

2.8 (704) (105 kW | 2.8 Liter)

05.86 → 12.90	B 280 F		246-075-044-001C	SWP-M-G	T1: 2
---------------	---------	--	------------------	---------	-------



			VDO		
Datum	Motorcode	Fahrgestell Nr.	Artikel Nr.	Artikelbez.	Information

VOLVO**760 (704, 764)****2.8 (704, 764) (115 kW | 2.8 Liter)**

02.82 → 06.85 B 28 E / B 280 E 246-075-044-001C SWP-M-G T1: 2

2.4 Turbo Diesel (704) (80 kW | 2.4 Liter)

04.87 → 07.92 D 24 T 246-075-044-001C SWP-M-G T1: 2

2.4 Turbo Diesel (704) (82 kW | 2.4 Liter)

08.82 → 06.87 D 24 T 246-075-044-001C SWP-M-G T1: 2

2.4 TD Interc. (704) (85 kW | 2.4 Liter)

08.87 → 12.90 D 24 TIC 246-075-044-001C SWP-M-G T1: 2

760 Kombi (704, 765)**2.8 (765) (105 kW | 2.8 Liter)**

05.86 → 12.90 B 280 F 246-075-044-001C SWP-M-G T1: 2

07.86 → 12.90 B 280 F 246-075-044-002A SWP-M-G T1: 2

780**2.9 (115 kW | 2.9 Liter)**

08.86 → 07.87 B 280 E 246-075-044-001C SWP-M-G T1: 2

850 (LS)**2.0 (93 kW | 2.0 Liter)**

08.94 → 12.96 B 5202 S 246-075-044-001C SWP-M-G T1: 2

2.0 (105 kW | 2.0 Liter)

06.91 → 12.96 B 5204 F 246-075-044-001C SWP-M-G T1: 2

2.0 Turbo (155 kW | 2.0 Liter)

01.94 → 12.96 B 5204 FT / B 5204 T 246-075-044-001C SWP-M-G T1: 2

2.3 T5 (166 kW | 2.3 Liter)

08.93 → 07.96 B 5234 FT 246-075-044-001C SWP-M-G T1: 2

2.3 T5-R (184 kW | 2.3 Liter)

08.95 → 12.96 B 5234 T4 246-075-044-001C SWP-M-G T1: 2

2.5 (103 kW | 2.5 Liter)

06.91 → 07.94 B 5252 246-075-044-001C SWP-M-G T1: 2

2.5 (106 kW | 2.5 Liter)

08.94 → 12.96 B 5252 S 246-075-044-001C SWP-M-G T1: 2

2.5 TDI (103 kW | 2.5 Liter)





02.96 → 12.96 D 5252 T 246-075-044-001C SWP-M-G T1: 2

850 Kombi (LW)**2.0 (93 kW | 2.0 Liter)**

08.94 → 12.96 B 5202 S 246-075-044-001C SWP-M-G T1: 2

08.94 → 12.96 B 5202 S 246-075-044-002A SWP-M-G T1: 2



			VDO		
Datum	Motorcode	Fahrgestell Nr.	Artikel Nr.	Artikelbez.	Information

VOLVO**850 Kombi (LW)****2.0 (105 kW | 2.0 Liter)**

02.93 → 12.96	B 5204 F		246-075-044-001C	SWP-M-G	T1: 2
02.93 → 12.96	B 5204 F		246-075-044-002A	SWP-M-G	T1: 2

2.0 Turbo (155 kW | 2.0 Liter)

01.94 → 12.96	B 5204 FT / B 5204 T		246-075-044-001C	SWP-M-G	T1: 2
01.94 → 12.96	B 5204 FT / B 5204 T		246-075-044-002A	SWP-M-G	T1: 2

2.3 T5 (166 kW | 2.3 Liter)

03.93 → 12.96	B 5234 FT		246-075-044-001C	SWP-M-G	T1: 2
03.93 → 12.96	B 5234 FT		246-075-044-002A	SWP-M-G	T1: 2

2.5 (103 kW | 2.5 Liter)

04.94 → 07.94	B 5252		246-075-044-001C	SWP-M-G	T1: 2
04.94 → 07.94	B 5252		246-075-044-002A	SWP-M-G	T1: 2

2.5 (125 kW | 2.5 Liter)

09.92 → 12.96	B 5254 S		246-075-044-001C	SWP-M-G	T1: 2
12.92 → 12.96	B 5254 S		246-075-044-002A	SWP-M-G	T1: 2

2.5 AWD (142 kW | 2.5 Liter)

06.96 → 12.96	B 5254 T		246-075-044-001C	SWP-M-G	T1: 2
06.96 → 12.96	B 5254 T		246-075-044-002A	SWP-M-G	T1: 2

2.5 TDI (103 kW | 2.5 Liter)

02.96 → 12.96	D 5252 T		246-075-044-001C	SWP-M-G	T1: 2
02.96 → 12.96	D 5252 T		246-075-044-002A	SWP-M-G	T1: 2

940 (944)**2.0 (82 kW | 2.0 Liter)**

01.92 → 07.94	B 200 F		246-075-044-001C	SWP-M-G	T1: 2
---------------	---------	--	------------------	---------	-------

2.3 (96 kW | 2.3 Liter)

09.91 → 12.94	B 230 FB / B 230 G	→ 227665	246-075-044-001C	SWP-M-G	T1: 2
---------------	--------------------	----------	------------------	---------	-------

2.3 (114 kW | 2.3 Liter)

09.90 → 07.91	B 234 F / B 234 G		246-075-044-001C	SWP-M-G	T1: 2
---------------	-------------------	--	------------------	---------	-------

2.3 Turbo (121 kW | 2.3 Liter)

09.90 → 07.94	B 230 FT		246-075-044-001C	SWP-M-G	T1: 2
---------------	----------	--	------------------	---------	-------

2.4 Turbo Diesel (80 kW | 2.4 Liter)

09.90 → 07.93	D 24 T		246-075-044-001C	SWP-M-G	T1: 2
---------------	--------	--	------------------	---------	-------

2.4 TD Intercooler (90 kW | 2.4 Liter)

08.90 → 07.93	D 24 TIC		246-075-044-001C	SWP-M-G	T1: 2
---------------	----------	--	------------------	---------	-------





940 Kombi (945)**2.0 (82 kW | 2.0 Liter)**

01.92 → 07.94	B 200 F		246-075-044-001C	SWP-M-G	T1: 2
01.92 → 07.94	B 200 F		246-075-044-002A	SWP-M-G	T1: 2

2.0 Turbo (114 kW | 2.0 Liter)

01.91 → 07.95	B 200 FT	→ 177655	246-075-044-001C	SWP-M-G	T1: 2
01.91 → 07.95	B 200 FT	→ 204601	246-075-044-002A	SWP-M-G	T1: 2



			VDO		
Datum	Motorcode	Fahrgestell Nr.	Artikel Nr.	Artikelbez.	Information

VOLVO**940 Kombi (945)****2.3 (96 kW | 2.3 Liter)**

09.90 → 12.94	B 230 FB	→ 177655	246-075-044-001C	SWP-M-G	T1: 2
09.90 → 12.94	B 230 FB	204602 →; → 204601	246-075-044-002A	SWP-M-G	T1: 2

2.3 (114 kW | 2.3 Liter)

09.90 → 07.91	B 234 F	→ 177655	246-075-044-001C	SWP-M-G	T1: 2
09.90 → 07.91	B 234 F	→ 204601	246-075-044-002A	SWP-M-G	T1: 2

2.3 Turbo (121 kW | 2.3 Liter)

09.90 → 07.94	B 230 FT	→ 33113	246-075-044-001C	SWP-M-G	T1: 2
09.90 → 07.94	B 230 FT		246-075-044-002A	SWP-M-G	T1: 2

2.3 Turbo (140 kW | 2.3 Liter)

08.91 → 06.93	B 230 FT+		246-075-044-001C	SWP-M-G	T1: 2
08.91 → 06.93	B 230 FT+		246-075-044-002A	SWP-M-G	T1: 2

2.4 Turbo Diesel (80 kW | 2.4 Liter)

09.90 → 07.93	D 24 T		246-075-044-001C	SWP-M-G	T1: 2
---------------	--------	--	------------------	---------	-------

940 II (944)**2.3 (85 kW | 2.3 Liter)**

08.94 → 07.95	B 230 FD	→ 227665	246-075-044-001C	SWP-M-G	T1: 2
---------------	----------	----------	------------------	---------	-------

2.3 Turbo (121 kW | 2.3 Liter)

08.94 → 12.97	B 230 FT	→ 227665	246-075-044-001C	SWP-M-G	T1: 2
---------------	----------	----------	------------------	---------	-------

2.4 TD Interc. (90 kW | 2.4 Liter)

08.94 → 12.97	D 24 TIC	→ 227665	246-075-044-001C	SWP-M-G	T1: 2
---------------	----------	----------	------------------	---------	-------

940 II Kombi (945)**2.3 (85 kW | 2.3 Liter)**

08.94 → 07.95	B 230 FD	→ 177655	246-075-044-001C	SWP-M-G	T1: 2
08.94 → 07.95	B 230 FD	→ 204601	246-075-044-002A	SWP-M-G	T1: 2

2.3 (96 kW | 2.3 Liter)

09.94 → 12.97	B 230 FB	→ 177655	246-075-044-001C	SWP-M-G	T1: 2
09.94 → 12.97	B 230 FB	→ 204601	246-075-044-002A	SWP-M-G	T1: 2

2.3 Turbo (121 kW | 2.3 Liter)

09.94 → 12.96	B 230 FT	→ 33113	246-075-044-001C	SWP-M-G	T1: 2
09.94 → 08.96	B 230 FT		246-075-044-002A	SWP-M-G	T1: 2

2.4 TD Interc. (90 kW | 2.4 Liter)

08.94 → 10.98	D 24 TIC	→ 177655	246-075-044-001C	SWP-M-G	T1: 2
08.94 → 12.97	D 24 TIC	→ 204601	246-075-044-002A	SWP-M-G	T1: 2

960 (964)**2.9 (150 kW | 2.9 Liter)**

09.90 → 07.94	B 6304 F	→ 89893	246-075-044-001C	SWP-M-G	T1: 2
---------------	----------	---------	------------------	---------	-------



			VDO		
Datum	Motorcode	Fahrgestell Nr.	Artikel Nr.	Artikelbez.	Information

VOLVO**960 (964)****2.4 TD Interc. (85 kW | 2.4 Liter)**

09.91 → 07.94	D 24 TIC		246-075-044-001C	SWP-M-G	T1: 2
---------------	----------	--	------------------	---------	-------

960 Kombi (965)**2.9 (150 kW | 2.9 Liter)**

09.90 → 07.94	B 6304 F / B 6304 S	→ 33113	246-075-044-001C	SWP-M-G	T1: 2
---------------	---------------------	---------	------------------	---------	-------

09.90 → 07.94	B 6304 F / B 6304 S		246-075-044-002A	SWP-M-G	T1: 2
---------------	---------------------	--	------------------	---------	-------

2.4 TD Interc. (85 kW | 2.4 Liter)

09.91 → 07.94	D 24 TIC	→ 33113	246-075-044-001C	SWP-M-G	T1: 2
---------------	----------	---------	------------------	---------	-------

09.91 → 07.94	D 24 TIC		246-075-044-002A	SWP-M-G	T1: 2
---------------	----------	--	------------------	---------	-------

960 II (964)**2.5 (125 kW | 2.5 Liter)**

09.94 → 12.96	B 6254 S	→ 89893	246-075-044-001C	SWP-M-G	T1: 2
---------------	----------	---------	------------------	---------	-------

960 II Kombi (965)**2.5 (125 kW | 2.5 Liter)**

09.94 → 12.96	B 6254 S	→ 33113	246-075-044-001C	SWP-M-G	T1: 2
---------------	----------	---------	------------------	---------	-------

09.94 → 12.96	B 6254 S		246-075-044-002A	SWP-M-G	T1: 2
---------------	----------	--	------------------	---------	-------

VW**BORA (1J2)****1.4 16V (55 kW | 1.4 Liter)**

03.00 →	AHW / AKQ / APE / AXP / BCA		246-082-008-025G	SWP-M-C	T1: 3
---------	-----------------------------	--	------------------	---------	-------

03.00 →	AHW / AKQ / APE / AXP / BCA		246-083-002-022G	SWP-D-C	T1: 3
---------	-----------------------------	--	------------------	---------	-------

03.00 →	AHW / AKQ / APE / AXP / BCA		246-086-001-002C	HLWP	T1: 3
---------	-----------------------------	--	------------------	------	-------

03.00 →	AHW / AKQ / APE / AXP / BCA		246-086-001-007C	HLWP	T1: 3b; T3: X11-246-003-014
---------	-----------------------------	--	------------------	------	--------------------------------

1.6 (74 kW | 1.6 Liter)

10.98 →	AEH / AKL / APF		246-082-008-025G	SWP-M-C	T1: 3
---------	-----------------	--	------------------	---------	-------

10.98 →	AEH / AKL / APF		246-083-002-022G	SWP-D-C	T1: 3
---------	-----------------	--	------------------	---------	-------





10.98 →	AEH / AKL / APF		246-086-001-002C	HLWP	T1: 3
---------	-----------------	--	------------------	------	-------

10.98 →	AEH / AKL / APF		246-086-001-007C	HLWP	T1: 3b; T3: X11-246-003-014
---------	-----------------	--	------------------	------	--------------------------------

1.6 (75 kW | 1.6 Liter)

08.00 →	AVU / BFQ		246-086-001-007C	HLWP	T1: 3b; T3: X11-246-003-014
---------	-----------	--	------------------	------	--------------------------------



			VDO		
Datum	Motorcode	Fahrgestell Nr.	Artikel Nr.	Artikelbez.	Information

VW**BORA (1J2)****1.6 16V (77 kW | 1.6 Liter)**

05.00 →	ATN / AUS / AZD / BCB		246-086-001-007C	HLWP	T1: 3b; T3: X11-246-003-014
---------	-----------------------	--	------------------	------	--------------------------------

1.6 FSI (81 kW | 1.6 Liter)

01.02 →	BAD		246-086-001-007C	HLWP	T1: 3b; T3: X11-246-003-014
---------	-----	--	------------------	------	--------------------------------

1.8 (92 kW | 1.8 Liter)

10.98 →	AGN		246-086-001-007C	HLWP	T1: 3b; T3: X11-246-003-014
---------	-----	--	------------------	------	--------------------------------

1.8 4motion (92 kW | 1.8 Liter)

02.99 →	AGN		246-082-008-025G	SWP-M-C	T1: 3
02.99 →	AGN		246-083-002-022G	SWP-D-C	T1: 3
02.99 →	AGN		246-086-001-002C	HLWP	T1: 3
02.99 →	AGN		246-086-001-007C	HLWP	T1: 3b; T3: X11-246-003-014

1.8 T (110 kW | 1.8 Liter)

05.00 →	AGU / ARX / AUM		246-086-001-007C	HLWP	T1: 3b; T3: X11-246-003-014
---------	-----------------	--	------------------	------	--------------------------------

1.8 T (132 kW | 1.8 Liter)

03.02 →	AUQ		246-086-001-007C	HLWP	T1: 3b; T3: X11-246-003-014
---------	-----	--	------------------	------	--------------------------------

2.0 (85 kW | 2.0 Liter)

10.98 →	APK / AQY / AZG / AZH / AZJ		246-082-008-025G	SWP-M-C	T1: 3
10.98 →	APK / AQY / AZG / AZH / AZJ		246-083-002-022G	SWP-D-C	T1: 3
10.98 →	APK / AQY / AZG / AZH / AZJ		246-086-001-002C	HLWP	T1: 3
10.98 →	APK / AQY / AZG / AZH / AZJ		246-086-001-007C	HLWP	T1: 3b; T3: X11-246-003-014

2.0 4motion (85 kW | 2.0 Liter)

04.00 →	AZH / AZJ		246-086-001-007C	HLWP	T1: 3b; T3: X11-246-003-014
---------	-----------	--	------------------	------	--------------------------------

2.3 V5 (110 kW | 2.3 Liter)

10.98 → 10.00	AGZ		246-082-008-025G	SWP-M-C	T1: 3
10.98 → 10.00	AGZ		246-083-002-022G	SWP-D-C	T1: 3
10.98 → 10.00	AGZ		246-086-001-002C	HLWP	T1: 3
10.98 → 10.00	AGZ		246-086-001-007C	HLWP	T1: 3b; T3: X11-246-003-014

2.3 V5 4motion (110 kW | 2.3 Liter)

01.99 → 10.00	AGZ		246-082-008-025G	SWP-M-C	T1: 3
01.99 → 10.00	AGZ		246-083-002-022G	SWP-D-C	T1: 3
01.99 → 10.00	AGZ		246-086-001-002C	HLWP	T1: 3
12.98 → 10.00	AGZ		246-086-001-007C	HLWP	T1: 3b; T3: X11-246-003-014

2.3 V5 (125 kW | 2.3 Liter)

10.00 →	AQN		246-086-001-007C	HLWP	T1: 3b; T3: X11-246-003-014
---------	-----	--	------------------	------	--------------------------------



			VDO		
Datum	Motorcode	Fahrgestell Nr.	Artikel Nr.	Artikelbez.	Information

VW**BORA (1J2)****2.3 V5 4motion (125 kW | 2.3 Liter)**

10.00 →	AQN		246-086-001-007C	HLWP	T1: 3b; T3: X11-246-003-014
---------	-----	--	------------------	------	--------------------------------

2.8 V6 4motion (150 kW | 2.8 Liter)

03.99 →	AQP / AUE / BDE		246-086-001-007C	HLWP	T1: 3b; T3: X11-246-003-014
---------	-----------------	--	------------------	------	--------------------------------

1.9 SDI (50 kW | 1.9 Liter)

10.98 → 04.01	AGP / AQM		246-082-008-025G	SWP-M-C	T1: 3
10.98 → 04.01	AGP / AQM		246-083-002-022G	SWP-D-C	T1: 3
10.98 → 04.01	AGP / AQM		246-086-001-002C	HLWP	T1: 3
10.98 →	AGP / AQM		246-086-001-007C	HLWP	T1: 3b; T3: X11-246-003-014

1.9 TDI (66 kW | 1.9 Liter)

10.98 → 06.01	AGR / ALH		246-082-008-025G	SWP-M-C	T1: 3
10.98 → 06.01	AGR / ALH		246-083-002-022G	SWP-D-C	T1: 3
10.98 → 06.01	AGR / ALH		246-086-001-002C	HLWP	T1: 3
10.98 → 06.01	AGR / ALH		246-086-001-007C	HLWP	T1: 3b; T3: X11-246-003-014

1.9 TDI 4motion (66 kW | 1.9 Liter)

02.99 → 06.01	AGR		246-082-008-025G	SWP-M-C	T1: 3
02.99 → 06.01	AGR		246-083-002-022G	SWP-D-C	T1: 3
02.99 → 06.01	AGR		246-086-001-002C	HLWP	T1: 3
02.99 → 06.01	AGR		246-086-001-007C	HLWP	T1: 3b; T3: X11-246-003-014

1.9 TDI (74 kW | 1.9 Liter)

05.01 →	ATD / AXR		246-082-008-025G	SWP-M-C	T1: 3
09.00 →	ATD / AXR		246-086-001-007C	HLWP	T1: 3b; T3: X11-246-003-014

1.9 TDI 4motion (74 kW | 1.9 Liter)

05.01 →	ATD		246-082-008-025G	SWP-M-C	T1: 3
09.00 →	ATD		246-086-001-007C	HLWP	T1: 3b; T3: X11-246-003-014





1.9 TDI (81 kW | 1.9 Liter)

10.98 → 06.01	AHF / ASV		246-082-008-025G	SWP-M-C	T1: 3
10.98 → 06.01	AHF / ASV		246-083-002-022G	SWP-D-C	T1: 3
10.98 → 06.01	AHF / ASV		246-086-001-002C	HLWP	T1: 3
10.98 → 06.01	AHF / ASV		246-086-001-007C	HLWP	T1: 3b; T3: X11-246-003-014

1.9 TDI (85 kW | 1.9 Liter)

12.98 → 06.01	AJM / AUJ		246-082-008-025G	SWP-M-C	T1: 3
03.99 → 06.01	AJM / AUJ		246-083-002-022G	SWP-D-C	T1: 3
03.99 → 06.01	AJM / AUJ		246-086-001-002C	HLWP	T1: 3
12.98 → 06.01	AJM / AUJ		246-086-001-007C	HLWP	T1: 3b; T3: X11-246-003-014



			VDO		
Datum	Motorcode	Fahrgestell Nr.	Artikel Nr.	Artikelbez.	Information

VW**BORA (1J2)****1.9 TDI 4motion (85 kW | 1.9 Liter)**

02.99 → 06.01	AJM / AUY		246-082-008-025G	SWP-M-C	T1: 3
02.99 → 06.01	AJM / AUY		246-086-001-007C	HLWP	T1: 3b; T3: X11-246-003-014

1.9 TDI (96 kW | 1.9 Liter)

05.01 →	ASZ		246-082-008-025G	SWP-M-C	T1: 3
11.00 →	ASZ		246-086-001-007C	HLWP	T1: 3b; T3: X11-246-003-014

1.9 TDI 4motion (96 kW | 1.9 Liter)

05.01 →	ASZ		246-082-008-025G	SWP-M-C	T1: 3
11.00 →	ASZ		246-086-001-007C	HLWP	T1: 3b; T3: X11-246-003-014

1.9 TDI (110 kW | 1.9 Liter)

05.01 →	ARL		246-082-008-025G	SWP-M-C	T1: 3
05.00 →	ARL		246-086-001-007C	HLWP	T1: 3b; T3: X11-246-003-014

1.9 TDI 4motion (110 kW | 1.9 Liter)

05.01 →	ARL		246-082-008-025G	SWP-M-C	T1: 3
05.00 →	ARL		246-086-001-007C	HLWP	T1: 3b; T3: X11-246-003-014

BORA Kombi (1J6)**1.4 16V (55 kW | 1.4 Liter)**

09.01 →	AHW / AXP / BCA		246-083-002-022G	SWP-D-C	T1: 3
---------	-----------------	--	------------------	---------	-------

1.6 (74 kW | 1.6 Liter)

05.99 →	AEH / AKL / APF		246-082-008-025G	SWP-M-C	T1: 3
05.99 →	AEH / AKL / APF		246-083-002-022G	SWP-D-C	T1: 3
05.99 →	AEH / AKL / APF		246-086-001-002C	HLWP	T1: 3

1.6 (75 kW | 1.6 Liter)

08.00 →	AVU / BFQ		246-083-002-022G	SWP-D-C	T1: 3
---------	-----------	--	------------------	---------	-------

1.6 16V (77 kW | 1.6 Liter)

02.00 →	ATN / AUS / AZD / BCB		246-083-002-022G	SWP-D-C	T1: 3
---------	-----------------------	--	------------------	---------	-------

1.6 FSI (81 kW | 1.6 Liter)

01.02 →	BAD		246-083-002-022G	SWP-D-C	T1: 3
---------	-----	--	------------------	---------	-------

1.8 4motion (92 kW | 1.8 Liter)

05.99 →	AGN		246-082-008-025G	SWP-M-C	T1: 3
05.99 →	AGN		246-083-002-022G	SWP-D-C	T1: 3
05.99 →	AGN		246-086-001-002C	HLWP	T1: 3





1.8 (110 kW | 1.8 Liter)

05.00 →	AGU / ARX / AUM		246-083-002-022G	SWP-D-C	T1: 3
---------	-----------------	--	------------------	---------	-------

1.8 T (132 kW | 1.8 Liter)

05.02 →	AUQ		246-083-002-022G	SWP-D-C	T1: 3
---------	-----	--	------------------	---------	-------



			VDO		
Datum	Motorcode	Fahrgestell Nr.	Artikel Nr.	Artikelbez.	Information

VW**BORA Kombi (1J6)****2.0 (85 kW | 2.0 Liter)**

05.99 →	APK / AQY / AZG / AZH / AZJ		246-082-008-025G	SWP-M-C	T1: 3
05.99 →	APK / AQY / AZG / AZH / AZJ		246-083-002-022G	SWP-D-C	T1: 3
05.99 →	APK / AQY / AZG / AZH / AZJ		246-086-001-002C	HLWP	T1: 3

2.0 4motion (85 kW | 2.0 Liter)

04.00 →	AZH / AZJ		246-083-002-022G	SWP-D-C	T1: 3
---------	-----------	--	------------------	---------	-------

2.3 V5 (110 kW | 2.3 Liter)

05.99 → 10.00	AGZ		246-082-008-025G	SWP-M-C	T1: 3
05.99 → 10.00	AGZ		246-083-002-022G	SWP-D-C	T1: 3
05.99 → 10.00	AGZ		246-086-001-002C	HLWP	T1: 3

2.3 V5 4motion (110 kW | 2.3 Liter)

05.99 → 10.00	AGZ		246-082-008-025G	SWP-M-C	T1: 3
05.99 → 10.00	AGZ		246-083-002-022G	SWP-D-C	T1: 3
05.99 → 10.00	AGZ		246-086-001-002C	HLWP	T1: 3

2.3 V5 (125 kW | 2.3 Liter)

10.00 →	AQN		246-083-002-022G	SWP-D-C	T1: 3
---------	-----	--	------------------	---------	-------

2.3 V5 4motion (125 kW | 2.3 Liter)

10.00 →	AQN		246-083-002-022G	SWP-D-C	T1: 3
---------	-----	--	------------------	---------	-------

2.8 V6 4motion (150 kW | 2.8 Liter)

05.99 →	AQP / AUE / BDE		246-082-008-025G	SWP-M-C	T1: 3
05.99 →	AQP / AUE / BDE		246-083-002-022G	SWP-D-C	T1: 3
05.99 →	AQP / AUE / BDE		246-086-001-002C	HLWP	T1: 3

1.9 TDI (66 kW | 1.9 Liter)

05.99 → 06.01	AGR		246-082-008-025G	SWP-M-C	T1: 3
05.99 → 06.01	AGR		246-083-002-022G	SWP-D-C	T1: 3

1.9 TDI (74 kW | 1.9 Liter)

05.01 →	ATD / AXR		246-082-008-025G	SWP-M-C	T1: 3
09.00 →	ATD / AXR		246-083-002-022G	SWP-D-C	T1: 3

1.9 TDI 4motion (74 kW | 1.9 Liter)

05.01 →	ATD		246-082-008-025G	SWP-M-C	T1: 3
09.00 →	ATD		246-083-002-022G	SWP-D-C	T1: 3

1.9 TDI (81 kW | 1.9 Liter)

05.99 → 06.01	AHF / ASV		246-082-008-025G	SWP-M-C	T1: 3
05.99 → 06.01	AHF / ASV		246-083-002-022G	SWP-D-C	T1: 3
05.99 → 06.01	AHF / ASV		246-086-001-002C	HLWP	T1: 3

1.9 TDI (85 kW | 1.9 Liter)

05.99 → 06.01	AJM / AUJ		246-082-008-025G	SWP-M-C	T1: 3
05.99 → 06.01	AJM / AUJ		246-083-002-022G	SWP-D-C	T1: 3
05.99 → 06.01	AJM / AUJ		246-086-001-002C	HLWP	T1: 3

1.9 TDI 4motion (85 kW | 1.9 Liter)

05.99 → 06.01	AJM / AUJ		246-082-008-025G	SWP-M-C	T1: 3
05.99 → 06.01	AJM / AUJ		246-083-002-022G	SWP-D-C	T1: 3
05.99 → 06.01	AJM / AUJ		246-086-001-002C	HLWP	T1: 3



			VDO		
Datum	Motorcode	Fahrgestell Nr.	Artikel Nr.	Artikelbez.	Information

VW**BORA Kombi (1J6)****1.9 TDI (96 kW | 1.9 Liter)**

11.00 →	ASZ		246-082-008-025G	SWP-M-C	T1: 3
11.00 →	ASZ		246-083-002-022G	SWP-D-C	T1: 3

1.9 TDI 4motion (96 kW | 1.9 Liter)

11.00 →	ASZ		246-082-008-025G	SWP-M-C	T1: 3
11.00 →	ASZ		246-083-002-022G	SWP-D-C	T1: 3

1.9 TDI (110 kW | 1.9 Liter)

05.01 →	ARL		246-082-008-025G	SWP-M-C	T1: 3
05.01 →	ARL		246-083-002-022G	SWP-D-C	T1: 3

1.9 TDI 4motion (110 kW | 1.9 Liter)

05.01 →	ARL		246-082-008-025G	SWP-M-C	T1: 3
05.01 →	ARL		246-083-002-022G	SWP-D-C	T1: 3

CADDY I (14)**1.5 (51 kW | 1.5 Liter)**

08.82 → 07.83	JB	- J - 000 001 →; → - N - 000 001	246-069-056-001Z	N	
08.82 → 07.83	JB		246-080-010-002Z	N-H	
08.82 → 07.83	JB		246-082-008-014C	SWP-M-C	T1: 1
08.82 → 07.83	JB		246-086-001-002C	HLWP	T1: 3
08.82 → 07.83	JB		246-086-001-007C	HLWP	T1: 3b; T3: X11-246-003-014

1.6 (55 kW | 1.6 Liter)

01.83 → 07.92	EW	- J - 000 001 →; → - N - 000 001	246-069-056-001Z	N	
01.83 → 07.92	EW		246-080-010-002Z	N-H	
08.83 → 07.92	EW		246-082-008-014C	SWP-M-C	T1: 1
08.83 → 07.92	EW		246-086-001-002C	HLWP	T1: 3
01.83 → 07.92	EW		246-086-001-007C	HLWP	T1: 3b; T3: X11-246-003-014

1.8 (70 kW | 1.8 Liter)

08.85 → 07.92	JH	- J - 000 001 →; → - N - 000 001	246-069-056-001Z	N	
08.85 → 07.92	JH		246-080-010-002Z	N-H	
08.85 → 07.90	JH		246-082-008-014C	SWP-M-C	T1: 1
08.85 → 07.90	JH		246-086-001-002C	HLWP	T1: 3
08.85 → 07.92	JH		246-086-001-007C	HLWP	T1: 3b; T3: X11-246-003-014

1.6 D (40 kW | 1.6 Liter)

08.82 → 07.92	JK / ME	- J - 000 001 →; → - N - 000 001	246-069-056-001Z	N	
08.82 → 07.92	JK / ME		246-080-010-002Z	N-H	
08.82 → 03.90	JK / ME		246-082-008-014C	SWP-M-C	T1: 1
08.82 → 03.90	JK / ME		246-086-001-002C	HLWP	T1: 3



			VDO		
Datum	Motorcode	Fahrgestell Nr.	Artikel Nr.	Artikelbez.	Information

VW**CADDY I (14)****1.6 D (40 kW | 1.6 Liter)**

08.82 → 07.92	JK / ME		246-086-001-007C	HLWP	T1: 3b; T3: X11-246-003-014
---------------	---------	--	------------------	------	--------------------------------

CADDY II Kombi (9K9B)**1.4 (44 kW | 1.4 Liter)**

11.95 → 01.04	AEX / AKV / APQ / AUD	→ 9K-1-512 000	246-082-008-021G	SWP-M-C	T1: 6
11.95 → 01.04	AEX / AKV / APQ / AUD	9K-1-512 001 →	246-082-008-025G	SWP-M-C	T1: 3
11.95 → 01.04	AEX / AKV / APQ / AUD	9K-1-512 001 →	246-083-002-022G	SWP-D-C	T1: 3
11.95 → 01.04	AEX / AKV / APQ / AUD	9K-1-512 001 →	246-086-001-007C	HLWP	T1: 3b

1.4 16V (55 kW | 1.4 Liter)

08.00 → 01.04	AUA	→ 9K-1-512 000	246-082-008-021G	SWP-M-C	T1: 6
08.00 → 01.04	AUA	9K-1-512 001 →	246-082-008-025G	SWP-M-C	T1: 3
08.00 → 01.04	AUA	9K-1-512 001 →	246-083-002-022G	SWP-D-C	T1: 3
08.00 → 01.04	AUA	9K-1-512 001 →	246-086-001-007C	HLWP	T1: 3b

1.6 (55 kW | 1.6 Liter)

11.95 → 05.97	1F	→ 9K-1-512 000	246-082-008-021G	SWP-M-C	T1: 6
11.95 → 05.97	1F	9K-1-512 001 →	246-082-008-025G	SWP-M-C	T1: 3
11.95 → 05.97	1F	9K-1-512 001 →	246-083-002-022G	SWP-D-C	T1: 3
11.95 → 05.97	1F	9K-1-512 001 →	246-086-001-007C	HLWP	T1: 3b

1.6 (55 kW | 1.6 Liter)

06.97 → 09.00	AEE	→ 9K-1-512 000	246-082-008-021G	SWP-M-C	T1: 6
06.97 → 09.00	AEE	9K-1-512 001 →	246-082-008-025G	SWP-M-C	T1: 3
06.97 → 09.00	AEE	9K-1-512 001 →	246-083-002-022G	SWP-D-C	T1: 3
06.97 → 09.00	AEE	9K-1-512 001 →	246-086-001-007C	HLWP	T1: 3b

1.7 SDI (42 kW | 1.7 Liter)

07.96 → 09.00	AHB	→ 9K-1-512 000	246-082-008-021G	SWP-M-C	T1: 6
07.96 → 09.00	AHB	9K-1-512 001 →	246-082-008-025G	SWP-M-C	T1: 3
07.96 → 09.00	AHB	9K-1-512 001 →	246-083-002-022G	SWP-D-C	T1: 3
07.96 → 09.00	AHB	9K-1-512 001 →	246-086-001-007C	HLWP	T1: 3b

1.9 D (47 kW | 1.9 Liter)

11.95 → 01.04	1Y	→ 9K-1-512 000	246-082-008-021G	SWP-M-C	T1: 6
11.95 → 01.04	1Y	9K-1-512 001 →	246-082-008-025G	SWP-M-C	T1: 3
11.95 → 01.04	1Y	9K-1-512 001 →	246-083-002-022G	SWP-D-C	T1: 3
11.95 → 01.04	1Y	9K-1-512 001 →	246-086-001-007C	HLWP	T1: 3b

1.9 SDI (47 kW | 1.9 Liter)

11.95 → 01.04	AEY / AYQ	→ 9K-1-512 000	246-082-008-021G	SWP-M-C	T1: 6
11.95 → 01.04	AEY / AYQ	9K-1-512 001 →	246-082-008-025G	SWP-M-C	T1: 3
11.95 → 01.04	AEY / AYQ	9K-1-512 001 →	246-083-002-022G	SWP-D-C	T1: 3
11.95 → 01.04	AEY / AYQ	9K-1-512 001 →	246-086-001-007C	HLWP	T1: 3b

1.9 TDI (66 kW | 1.9 Liter)

10.96 → 01.04	AHU / ALE / ALH	→ 9K-1-512 000	246-082-008-021G	SWP-M-C	T1: 6
10.96 → 01.04	AHU / ALE / ALH	9K-1-512 001 →	246-082-008-025G	SWP-M-C	T1: 3
10.96 → 01.04	AHU / ALE / ALH	9K-1-512 001 →	246-083-002-022G	SWP-D-C	T1: 3



			VDO		
Datum	Motorcode	Fahrgestell Nr.	Artikel Nr.	Artikelbez.	Information

VW**CADDY II Kombi (9K9B)****1.9 TDI (66 kW | 1.9 Liter)**

10.96 → 01.04	AHU / ALE / ALH	9K-1-512 001 →	246-086-001-007C	HLWP	T1: 3b
---------------	-----------------	----------------	------------------	------	--------

CADDY II Kasten (9K9A)**60 1.4 (44 kW | 1.4 Liter)**

11.95 → 01.04	AEX / APQ / AUD		246-069-056-001Z	N	
11.95 → 01.04	AEX / APQ / AUD		246-080-010-002Z	N-H	
11.95 → 12.97	AEX / APQ / AUD		246-082-008-021G	SWP-M-C	T1: 6
11.95 → 12.97	AEX / APQ / AUD		246-083-002-014G	SWP-D-C	T1: 6
11.95 → 12.97	AEX / APQ / AUD		246-086-001-007C	HLWP	T1: 3b; T3: X11-246-003-014

1.4 (55 kW | 1.4 Liter)

08.00 → 01.04	AUA		246-069-056-001Z	N	
08.00 → 01.04	AUA		246-080-010-002Z	N-H	
08.00 → 01.04	AUA		246-086-001-007C	HLWP	T1: 3b; T3: X11-246-003-014

75 1.6 (55 kW | 1.6 Liter)

11.95 → 05.97	1F	→ 9K-1-512 000	246-082-008-021G	SWP-M-C	T1: 6
11.95 → 05.97	1F	9K-1-512 001 →	246-082-008-025G	SWP-M-C	T1: 3
11.95 → 05.97	1F	9K-1-512 001 →	246-083-002-022G	SWP-D-C	T1: 3
11.95 → 05.97	1F	9K-1-512 001 →	246-086-001-007C	HLWP	T1: 3b

75 1.6 (55 kW | 1.6 Liter)

11.95 → 09.00	AEE		246-069-056-001Z	N	
11.95 → 09.00	AEE		246-080-010-002Z	N-H	
11.95 → 09.00	AEE		246-086-001-007C	HLWP	T1: 3b; T3: X11-246-003-014

1.7 SDI (42 kW | 1.7 Liter)

07.96 → 09.00	AHB		246-069-056-001Z	N	
07.96 → 09.00	AHB		246-080-010-002Z	N-H	
07.96 → 09.00	AHB		246-082-008-021G	SWP-M-C	T1: 6
07.96 → 09.00	AHB		246-083-002-014G	SWP-D-C	T1: 6
07.96 → 09.00	AHB		246-086-001-007C	HLWP	T1: 3b; T3: X11-246-003-014

1.9 D (47 kW | 1.9 Liter)

11.95 → 01.04	1Y		246-069-056-001Z	N	
11.95 → 01.04	1Y		246-080-010-002Z	N-H	
11.95 → 01.04	1Y		246-082-008-021G	SWP-M-C	T1: 6
11.95 → 01.04	1Y		246-083-002-014G	SWP-D-C	T1: 6
11.95 → 01.04	1Y		246-086-001-007C	HLWP	T1: 3b; T3: X11-246-003-014



			VDO		
Datum	Motorcode	Fahrgestell Nr.	Artikel Nr.	Artikelbez.	Information

VW**CADDY II Kasten (9K9A)****1.9 SDI (47 kW | 1.9 Liter)**

11.95 → 01.04	AEY / AYQ		246-069-056-001Z	N	
11.95 → 01.04	AEY / AYQ		246-080-010-002Z	N-H	
11.95 → 01.04	AEY / AYQ		246-086-001-007C	HLWP	T1: 3b; T3: X11-246-003-014

1.9 TDI (66 kW | 1.9 Liter)

09.96 → 01.04	1Z / AHU / ALH		246-069-056-001Z	N	
09.96 → 01.04	1Z / AHU / ALH		246-080-010-002Z	N-H	
12.96 → 01.04	1Z / AHU / ALH		246-082-008-021G	SWP-M-C	T1: 6
12.96 → 01.04	1Z / AHU / ALH		246-083-002-014G	SWP-D-C	T1: 6
12.96 → 01.04	1Z / AHU / ALH		246-086-001-007C	HLWP	T1: 3b; T3: X11-246-003-014

CADDY II Pick-up (9U7)**1.6 (55 kW | 1.6 Liter)**

06.96 → 12.00	AEE		246-086-001-007C	HLWP	T1: 3b
---------------	-----	--	------------------	------	--------

1.9 D (47 kW | 1.9 Liter)

06.96 → 12.00	AEF		246-086-001-007C	HLWP	T1: 3b
---------------	-----	--	------------------	------	--------

CADDY III Kombi (2KB)**1.4 (55 kW | 1.4 Liter)**

03.04 →	BCA		246-083-002-022G	SWP-D-C	T1: 3
03.04 →	BCA		246-086-001-007C	HLWP	T1: 3b

1.6 (75 kW | 1.6 Liter)

04.04 →	BGU		246-083-002-022G	SWP-D-C	T1: 3
04.04 →	BGU		246-086-001-007C	HLWP	T1: 3b

1.9 TDI (77 kW | 1.9 Liter)

04.04 →	BJB		246-083-002-022G	SWP-D-C	T1: 3
04.04 →	BJB		246-086-001-007C	HLWP	T1: 3b

2.0 SDI (51 kW | 2.0 Liter)

03.04 →	BDJ		246-083-002-022G	SWP-D-C	T1: 3
03.04 →	BDJ		246-086-001-007C	HLWP	T1: 3b

CADDY III Kasten (2KA)**1.4 (55 kW | 1.4 Liter)**

03.04 →	BCA		246-082-008-025G	SWP-M-C	T1: 3
03.04 →	BCA		246-083-002-022G	SWP-D-C	T1: 3
03.04 →	BCA		246-086-001-007C	HLWP	T1: 3b

1.6 (75 kW | 1.6 Liter)

04.04 →	BGU		246-082-008-025G	SWP-M-C	T1: 3
04.04 →	BGU		246-083-002-022G	SWP-D-C	T1: 3
04.04 →	BGU		246-086-001-007C	HLWP	T1: 3b



			VDO		
Datum	Motorcode	Fahrgestell Nr.	Artikel Nr.	Artikelbez.	Information

VW**CADDY III Kasten (2KA)****1.9 TDI (77 kW | 1.9 Liter)**

04.04 →	BJB		246-082-008-025G	SWP-M-C	T1: 3
04.04 →	BJB		246-083-002-022G	SWP-D-C	T1: 3
04.04 →	BJB		246-086-001-007C	HLWP	T1: 3b

2.0 SDI (51 kW | 2.0 Liter)

03.04 →	BDJ		246-082-008-025G	SWP-M-C	T1: 3
03.04 →	BDJ		246-083-002-022G	SWP-D-C	T1: 3
03.04 →	BDJ		246-086-001-007C	HLWP	T1: 3b

CORRADO (53I)**1.8 16V (100 kW | 1.8 Liter)**

04.89 → 07.92	KR		246-069-056-001Z	N	
04.89 → 07.92	KR		246-080-010-002Z	N-H	
04.89 → 07.91	KR		246-082-008-014C	SWP-M-C	T1: 1
04.89 → 07.91	KR		246-083-002-006G	SWP-D-C	T1: 1
04.89 → 07.92	KR		246-083-002-014G	SWP-D-C	T1: 6
04.89 → 07.92	KR		246-086-001-007C	HLWP	T1: 3b; T3: X11-246-003-014

1.8 G60 (118 kW | 1.8 Liter)

09.88 → 09.93	PG		246-069-056-001Z	N	
09.88 → 09.93	PG		246-080-010-002Z	N-H	
09.88 → 07.91	PG		246-082-008-014C	SWP-M-C	T1: 1
09.88 → 07.91	PG		246-083-002-006G	SWP-D-C	T1: 1
09.88 → 09.93	PG		246-083-002-014G	SWP-D-C	T1: 6
09.88 → 09.93	PG		246-086-001-007C	HLWP	T1: 3b; T3: X11-246-003-014

2.0 i (85 kW | 2.0 Liter)

04.93 → 12.95	2E / ADY		246-069-056-001Z	N	
04.93 → 12.95	2E / ADY		246-080-010-002Z	N-H	
04.93 → 07.95	2E / ADY		246-082-008-014C	SWP-M-C	T1: 1
04.93 → 07.95	2E / ADY		246-083-002-006G	SWP-D-C	T1: 1
04.93 → 12.95	2E / ADY		246-083-002-014G	SWP-D-C	T1: 6
04.93 → 12.95	2E / ADY		246-086-001-007C	HLWP	T1: 3b; T3: X11-246-003-014

2.0 i 16V (100 kW | 2.0 Liter)

08.91 → 12.95	9A		246-069-056-001Z	N	
08.91 → 12.95	9A		246-080-010-002Z	N-H	
08.91 → 07.94	9A		246-082-008-014C	SWP-M-C	T1: 1
08.91 → 07.94	9A		246-083-002-006G	SWP-D-C	T1: 1
08.91 → 12.95	9A		246-083-002-014G	SWP-D-C	T1: 6
08.91 → 12.95	9A		246-086-001-007C	HLWP	T1: 3b; T3: X11-246-003-014



			VDO		
Datum	Motorcode	Fahrgestell Nr.	Artikel Nr.	Artikelbez.	Information

VW**CORRADO (53I)****2.9 VR6 (140 kW | 2.9 Liter)**

08.91 → 12.95	ABV		246-069-056-001Z	N	
08.91 → 12.95	ABV		246-080-010-002Z	N-H	
08.91 → 07.95	ABV		246-082-008-014C	SWP-M-C	T1: 1
08.91 → 07.95	ABV		246-083-002-006G	SWP-D-C	T1: 1
08.91 → 12.95	ABV		246-083-002-014G	SWP-D-C	T1: 6
08.91 → 12.95	ABV		246-086-001-007C	HLWP	T1: 3b; T3: X11-246-003-014

DERBY (86)**0.9 (29 kW | 0.9 Liter)**

02.77 → 11.78	HA	→ 869 2556 859	246-075-021-006C	SWP-M-G	T1: 1; T2: B
11.78 → 09.81	HA	869 2556 860 →	246-082-008-014C	SWP-M-C	T1: 1
02.77 → 09.81	HA		246-086-001-007C	HLWP	T1: 3b; T3: X11-246-003-014

1.1 (37 kW | 1.1 Liter)

02.77 → 11.78	HB	→ 869 2556 859	246-075-021-006C	SWP-M-G	T1: 1; T2: B
11.78 → 09.81	HB	869 2556 860 →	246-082-008-014C	SWP-M-C	T1: 1
02.77 → 09.81	HB		246-086-001-007C	HLWP	T1: 3b; T3: X11-246-003-014

1.3 (44 kW | 1.3 Liter)

02.77 → 11.78	HH	→ 869 2556 859	246-075-021-006C	SWP-M-G	T1: 1; T2: B
11.78 → 09.81	HH	869 2556 860 →	246-082-008-014C	SWP-M-C	T1: 1
02.77 → 09.81	HH		246-086-001-007C	HLWP	T1: 3b; T3: X11-246-003-014

DERBY (86C, 80)**1.0 (29 kW | 1.0 Liter)**

10.81 → 10.84	GL		246-082-008-014C	SWP-M-C	T1: 1
10.81 → 12.84	GL		246-086-001-007C	HLWP	T1: 3b; T3: X11-246-003-014

1.1 (37 kW | 1.1 Liter)

10.81 → 07.83	HB		246-082-008-014C	SWP-M-C	T1: 1
10.81 → 07.83	HB		246-086-001-007C	HLWP	T1: 3b; T3: X11-246-003-014

1.3 (40 kW | 1.3 Liter)

08.83 → 10.84	HK		246-082-008-014C	SWP-M-C	T1: 1
08.83 → 12.84	HK		246-086-001-007C	HLWP	T1: 3b; T3: X11-246-003-014

1.3 (44 kW | 1.3 Liter)

10.81 → 07.83	HH		246-082-008-014C	SWP-M-C	T1: 1
08.81 → 07.83	HH		246-086-001-007C	HLWP	T1: 3b; T3: X11-246-003-014



			VDO		
Datum	Motorcode	Fahrgestell Nr.	Artikel Nr.	Artikelbez.	Information

VW**DERBY (86C, 80)****1.3 (55 kW | 1.3 Liter)**

08.83 → 10.84	GK		246-082-008-014C	SWP-M-C	T1: 1
09.82 → 12.84	GK		246-086-001-007C	HLWP	T1: 3b; T3: X11-246-003-014

FOX (5Z1)**1.2 (40 kW | 1.2 Liter)**

04.05 →	BMD		246-082-008-025G	SWP-M-C	T1: 3
04.05 →	BMD		246-083-002-022G	SWP-D-C	T1: 3

1.4 (55 kW | 1.4 Liter)

04.05 →	BKR		246-082-008-025G	SWP-M-C	T1: 3
04.05 →	BKR		246-083-002-022G	SWP-D-C	T1: 3

1.4 TDI (51 kW | 1.4 Liter)

04.05 →	BNM		246-082-008-025G	SWP-M-C	T1: 3
04.05 →	BNM		246-083-002-022G	SWP-D-C	T1: 3

GOLF I (17)**1.1 (37 kW | 1.1 Liter)**

04.74 → 12.77	FA / GG	→ 177 3207 177	246-075-021-006C	SWP-M-G	T1: 1; T2: B
12.77 → 07.79	FA / GG	177 3207 178 →	246-082-008-014C	SWP-M-C	T1: 1
08.78 → 07.83	FA / GG		246-086-001-007C	HLWP	T1: 3b; T3: X11-246-003-014

1.1 (38 kW | 1.1 Liter)

01.81 → 07.83	FJ		246-082-008-014C	SWP-M-C	T1: 1
01.81 → 07.83	FJ		246-086-001-007C	HLWP	T1: 3b; T3: X11-246-003-014

1.1 (44 kW | 1.1 Liter)

01.81 → 07.83	HC		246-086-001-007C	HLWP	T1: 3b; T3: X11-246-003-014
---------------	----	--	------------------	------	--------------------------------

1.3 (44 kW | 1.3 Liter)

08.79 → 07.83	GF		246-082-008-014C	SWP-M-C	T1: 1
08.79 → 07.83	GF		246-086-001-007C	HLWP	T1: 3b; T3: X11-246-003-014

1.5 (51 kW | 1.5 Liter)

08.77 → 12.77	JB	→ 177 3207 177	246-075-021-006C	SWP-M-G	T1: 1; T2: B
12.77 → 07.83	JB	177 3207 178 →	246-082-008-014C	SWP-M-C	T1: 1
08.78 → 07.83	JB		246-086-001-007C	HLWP	T1: 3b; T3: X11-246-003-014

1.5 (51 kW | 1.5 Liter)

04.74 → 12.75	FH		246-075-021-006C	SWP-M-G	T1: 1; T2: B
---------------	----	--	------------------	---------	--------------

1.6 (55 kW | 1.6 Liter)

08.75 → 02.84	EM / FN / FP		246-075-021-006C	SWP-M-G	T1: 1; T2: B
---------------	--------------	--	------------------	---------	--------------



			VDO		
Datum	Motorcode	Fahrgestell Nr.	Artikel Nr.	Artikelbez.	Information

VW**GOLF I (17)****1.6 GTI (81 kW | 1.6 Liter)**

08.78 → 07.82	EG		246-082-008-014C	SWP-M-C	T1: 1
08.78 → 07.82	EG		246-086-001-007C	HLWP	T1: 3b; T3: X11-246-003-014

1.8 GTI (82 kW | 1.8 Liter)

08.82 → 07.83	DX / JJ		246-082-008-014C	SWP-M-C	T1: 1
08.82 → 09.83	DX / JJ		246-086-001-007C	HLWP	T1: 3b; T3: X11-246-003-014

1.5 D (37 kW | 1.5 Liter)

08.76 → 12.77	CK	→ 177 3207 177	246-075-021-006C	SWP-M-G	T1: 1; T2: B
12.77 → 07.80	CK	177 3207 178 →	246-082-008-014C	SWP-M-C	T1: 1
08.78 → 07.80	CK		246-086-001-007C	HLWP	T1: 3b; T3: X11-246-003-014

1.6 D (40 kW | 1.6 Liter)

08.80 → 07.83	CR / JK		246-082-008-014C	SWP-M-C	T1: 1
08.80 → 07.83	CR / JK		246-086-001-007C	HLWP	T1: 3b; T3: X11-246-003-014

1.6 TD (51 kW | 1.6 Liter)

03.82 → 07.83	CY		246-082-008-014C	SWP-M-C	T1: 1
03.82 → 07.83	CY		246-086-001-007C	HLWP	T1: 3b; T3: X11-246-003-014

GOLF I Cabriolet (155)**1.5 (51 kW | 1.5 Liter)**

02.79 → 07.83	JB		246-082-008-014C	SWP-M-C	T1: 1
01.79 → 11.83	JB		246-086-001-007C	HLWP	T1: 3b; T3: X11-246-003-014; T7: GL →





1.6 (53 kW | 1.6 Liter)

08.87 → 02.90	RE	- J - 000 001 →; → - P - 000 001	246-069-056-001Z	N	
08.89 → 02.90	RE	- L - 000 001 →	246-080-010-002Z	N-H	
04.86 → 02.90	RE		246-082-008-014C	SWP-M-C	T1: 1
04.86 → 02.90	RE		246-086-001-007C	HLWP	T1: 3b; T3: X11-246-003-014; T7: GL →

1.6 (55 kW | 1.6 Liter)

08.87 → 04.92	EW	- J - 000 001 →; → - P - 000 001	246-069-056-001Z	N	
08.89 → 04.92	EW	- L - 000 001 →	246-080-010-002Z	N-H	
08.83 → 04.92	EW		246-082-008-014C	SWP-M-C	T1: 1
08.83 → 04.92	EW		246-086-001-007C	HLWP	T1: 3b; T3: X11-246-003-014; T7: GL →



			VDO		
Datum	Motorcode	Fahrgestell Nr.	Artikel Nr.	Artikelbez.	Information

VW**GOLF I Cabriolet (155)****1.6 (81 kW | 1.6 Liter)**

08.79 → 07.82	EG		246-082-008-014C	SWP-M-C	T1: 1
08.79 → 07.82	EG		246-086-001-007C	HLWP	T1: 3b; T3: X11-246-003-014; T7: GL →

1.8 (66 kW | 1.8 Liter)

08.87 → 09.92	EX	- J - 000 001 →; → - P - 000 001	246-069-056-001Z	N	
08.89 → 09.92	EX	- L - 000 001 →	246-080-010-002Z	N-H	
08.83 → 09.92	EX		246-082-008-014C	SWP-M-C	T1: 1
08.83 → 09.92	EX		246-086-001-007C	HLWP	T1: 3b; T3: X11-246-003-014; T7: GL →

1.8 (70 kW | 1.8 Liter)

08.87 → 04.93	JH	- J - 000 001 →; → - P - 000 001	246-069-056-001Z	N	
08.89 → 04.93	JH	- L - 000 001 →	246-080-010-002Z	N-H	
08.83 → 04.93	JH		246-082-008-014C	SWP-M-C	T1: 1
08.83 → 04.93	JH		246-086-001-007C	HLWP	T1: 3b; T3: X11-246-003-014; T7: GL →

1.8 (72 kW | 1.8 Liter)

08.89 → 03.93	2H	- J - 000 001 →; → - P - 000 001	246-069-056-001Z	N	
08.89 → 03.93	2H	- L - 000 001 →	246-080-010-002Z	N-H	
08.89 → 03.93	2H		246-082-008-014C	SWP-M-C	T1: 1
08.89 → 03.93	2H		246-086-001-007C	HLWP	T1: 3b; T3: X11-246-003-014; T7: GL →

1.8 (82 kW | 1.8 Liter)

08.87 → 12.89	DX / EV / PB	- J - 000 001 →; → - P - 000 001	246-069-056-001Z	N	
08.89 → 12.89	DX / EV / PB	- L - 000 001 →	246-080-010-002Z	N-H	
08.83 → 12.89	DX / EV / PB		246-082-008-014C	SWP-M-C	T1: 1
08.82 → 12.89	DX / EV / PB		246-086-001-007C	HLWP	T1: 3b; T3: X11-246-003-014; T7: GL →

GOLF II (19E, 1G1)**1.0 (33 kW | 1.0 Liter)**

11.83 → 07.85	GN		246-082-008-014C	SWP-M-C	T1: 1
11.83 → 08.85	GN		246-086-001-007C	HLWP	T1: 3b; T3: X11-246-003-014; T7: C →



			VDO		
Datum	Motorcode	Fahrgestell Nr.	Artikel Nr.	Artikelbez.	Information

VW**GOLF II (19E, 1G1)****1.0 (37 kW | 1.0 Liter)**

10.85 → 01.86	HZ	→ G - 383 355	246-082-008-014C	SWP-M-C	T1: 1
01.86 → 07.88	HZ	G - 383 356 →	246-083-002-014G	SWP-D-C	T1: 6
08.85 → 10.91	HZ		246-086-001-007C	HLWP	T1: 3b; T3: X11-246-003-014; T7: C →

1.3 (37 kW | 1.3 Liter)

08.86 → 12.87	NU		246-083-002-014G	SWP-D-C	T1: 6
08.85 → 12.87	NU		246-086-001-007C	HLWP	T1: 3b; T3: X11-246-003-014; T7: C →

1.3 (40 kW | 1.3 Liter)

08.83 → 01.86	HK / MH	→ G - 383 355	246-082-008-014C	SWP-M-C	T1: 1
01.86 → 06.87	HK / MH	G - 383 356 →	246-083-002-014G	SWP-D-C	T1: 6
08.83 → 06.87	HK / MH		246-086-001-007C	HLWP	T1: 3b; T3: X11-246-003-014; T7: C →

1.3 KAT (40 kW | 1.3 Liter)

01.89 → 10.91	2G / MH / NZ		246-083-002-014G	SWP-D-C	T1: 6
06.86 → 12.92	2G / MH / NZ		246-086-001-007C	HLWP	T1: 3b; T3: X11-246-003-014; T7: C →

1.3 (44 kW | 1.3 Liter)

08.83 → 07.85	GT		246-082-008-014C	SWP-M-C	T1: 1
08.83 → 10.86	GT		246-086-001-007C	HLWP	T1: 3b; T3: X11-246-003-014; T7: C →

1.6 (51 kW | 1.6 Liter)

08.88 → 10.91	PN		246-083-002-014G	SWP-D-C	T1: 6
10.86 → 12.92	PN		246-086-001-007C	HLWP	T1: 3b; T3: X11-246-003-014; T7: C →

1.6 (53 kW | 1.6 Liter)

02.86 → 10.91	RF		246-083-002-014G	SWP-D-C	T1: 6
02.86 → 10.91	RF		246-086-001-007C	HLWP	T1: 3b; T3: X11-246-003-014; T7: C →

1.6 (55 kW | 1.6 Liter)

08.83 → 01.86	ABN / EZ / HM	→ G - 383 355	246-082-008-014C	SWP-M-C	T1: 1
01.86 → 10.91	ABN / EZ / HM	G - 383 356 →	246-083-002-014G	SWP-D-C	T1: 6
08.83 → 07.92	ABN / EZ / HM		246-086-001-007C	HLWP	T1: 3b; T3: X11-246-003-014; T7: C →



			VDO		
Datum	Motorcode	Fahrgestell Nr.	Artikel Nr.	Artikelbez.	Information

VW**GOLF II (19E, 1G1)****1.8 (62 kW | 1.8 Liter)**

08.88 → 01.90	RH		246-083-002-014G	SWP-D-C	T1: 6
08.86 → 01.90	RH		246-086-001-007C	HLWP	T1: 3b; T3: X11-246-003-014; T7: C →

1.8 (66 kW | 1.8 Liter)

08.84 → 01.86	GU / GX / HV	→ G - 383 355	246-082-008-014C	SWP-M-C	T1: 1
01.86 → 10.91	GU / GX / HV	G - 383 356 →	246-083-002-014G	SWP-D-C	T1: 6
08.84 → 10.91	GU / GX / HV		246-086-001-007C	HLWP	T1: 3b; T3: X11-246-003-014; T7: C →

1.8 i KAT (66 kW | 1.8 Liter)

08.87 → 10.91	GX / RP	G - 383 356 →	246-083-002-014G	SWP-D-C	T1: 6
08.87 → 10.91	GX / RP		246-086-001-007C	HLWP	T1: 3b; T3: X11-246-003-014; T7: C →

1.8 Syncro (66 kW | 1.8 Liter)

02.86 → 07.91	GU / GX		246-083-002-014G	SWP-D-C	T1: 6
02.86 → 07.91	GU / GX		246-086-001-007C	HLWP	T1: 3b; T3: X11-246-003-014; T7: C →

1.8 i Syncro KAT (66 kW | 1.8 Liter)

08.87 → 10.91	RP		246-086-001-007C	HLWP	T1: 3b; T3: X11-246-003-014; T7: C →
---------------	----	--	------------------	------	--------------------------------------------

1.8 Syncro (72 kW | 1.8 Liter)

08.88 → 07.91	1P		246-086-001-007C	HLWP	T1: 3b; T3: X11-246-003-014; T7: C →
---------------	----	--	------------------	------	--------------------------------------------

1.8 GTI (79 kW | 1.8 Liter)

08.85 → 10.87	RD		246-086-001-007C	HLWP	T1: 3b; T3: X11-246-003-014; T7: C →
---------------	----	--	------------------	------	--------------------------------------------

1.8 GTI KAT (79 kW | 1.8 Liter)

01.87 → 10.91	PF		246-083-002-014G	SWP-D-C	T1: 6
01.87 → 10.91	PF		246-086-001-007C	HLWP	T1: 3b; T3: X11-246-003-014; T7: C →

1.8 GTI (82 kW | 1.8 Liter)

01.84 → 01.86	DX / EV / GZ / PB	→ G - 383 355	246-082-008-014C	SWP-M-C	T1: 1
01.86 → 10.91	DX / EV / GZ / PB	G - 383 356 →	246-083-002-014G	SWP-D-C	T1: 6
08.83 → 10.91	DX / EV / GZ / PB		246-086-001-007C	HLWP	T1: 3b; T3: X11-246-003-014; T7: C →



			VDO		
Datum	Motorcode	Fahrgestell Nr.	Artikel Nr.	Artikelbez.	Information

VW**GOLF II (19E, 1G1)****1.8 GTI 16V (95 kW | 1.8 Liter)**

02.86 → 10.91	PL		246-083-002-014G	SWP-D-C	T1: 6
02.86 → 10.91	PL		246-086-001-007C	HLWP	T1: 3b; T3: X11-246-003-014; T7: C →

1.8 GTI 16V (102 kW | 1.8 Liter)

02.86 → 06.90	KR		246-083-002-014G	SWP-D-C	T1: 6
02.86 → 06.90	KR		246-086-001-007C	HLWP	T1: 3b; T3: X11-246-003-014; T7: C →

1.8 GTI G60 (118 kW | 1.8 Liter)

04.90 → 07.91	PG		246-083-002-014G	SWP-D-C	T1: 6
04.90 → 07.91	PG		246-086-001-007C	HLWP	T1: 3b; T3: X11-246-003-014; T7: C →

1.8 GTI G60 Syncro (118 kW | 1.8 Liter)

04.89 → 07.91	1H / PG		246-083-002-014G	SWP-D-C	T1: 6
08.88 → 07.91	1H / PG		246-086-001-007C	HLWP	T1: 3b; T3: X11-246-003-014; T7: C →

1.6 D (37 kW | 1.6 Liter)

08.83 → 10.91			246-086-001-007C	HLWP	T1: 3b; T3: X11-246-003-014; T7: C →
---------------	--	--	------------------	------	--------------------------------------------

1.6 D (40 kW | 1.6 Liter)

08.83 → 01.86	JP / ME	→ G - 383 355	246-082-008-014C	SWP-M-C	T1: 1
01.86 → 10.91	JP / ME	G - 383 356 →	246-083-002-014G	SWP-D-C	T1: 6
08.83 → 10.91	JP / ME		246-086-001-007C	HLWP	T1: 3b; T3: X11-246-003-014; T7: C →

1.6 TD (44 kW | 1.6 Liter)

08.89 → 10.91	1V		246-083-002-014G	SWP-D-C	T1: 6
08.89 → 10.91	1V		246-086-001-007C	HLWP	T1: 3b; T3: X11-246-003-014; T7: C →

1.6 TD (51 kW | 1.6 Liter)

08.83 → 01.86	JR / MF	→ G - 383 355	246-082-008-014C	SWP-M-C	T1: 1
01.86 → 10.91	JR / MF	G - 383 356 →	246-083-002-014G	SWP-D-C	T1: 6
08.83 → 10.91	JR / MF		246-086-001-007C	HLWP	T1: 3b; T3: X11-246-003-014; T7: C →



			VDO		
Datum	Motorcode	Fahrgestell Nr.	Artikel Nr.	Artikelbez.	Information

VW**GOLF II (19E, 1G1)****1.6 TD (59 kW | 1.6 Liter)**

04.89 → 10.91	RA / SB		246-083-002-014G	SWP-D-C	T1: 6
04.89 → 10.91	RA / SB		246-086-001-007C	HLWP	T1: 3b; T3: X11-246-003-014; T7: C →

GOLF III (1H1)**1.4 (40 kW | 1.4 Liter)**

11.91 → 08.97	ABD / AEX		246-069-056-001Z	N	
11.91 → 08.97	ABD / AEX		246-080-010-002Z	N-H	T7: CL →
11.91 → 06.95	ABD / AEX		246-083-002-014G	SWP-D-C	T1: 6
11.91 → 06.95	ABD / AEX		246-086-001-002C	HLWP	T1: 3
11.91 → 08.97	ABD / AEX		246-086-001-007C	HLWP	T1: 3b; T3: X11-246-003-014; T7: CL →

1.4 (44 kW | 1.4 Liter)

10.91 → 08.97	ABD / AEX		246-069-056-001Z	N	
10.91 → 08.97	ABD / AEX		246-080-010-002Z	N-H	T7: CL →
07.94 → 08.97	ABD / AEX		246-083-002-014G	SWP-D-C	T1: 6
07.94 → 08.97	ABD / AEX		246-086-001-002C	HLWP	T1: 3
10.91 → 08.97	ABD / AEX		246-086-001-007C	HLWP	T1: 3b; T3: X11-246-003-014; T7: CL →

1.6 (55 kW | 1.6 Liter)

09.92 → 08.97	ABU / AEA / AEE		246-069-056-001Z	N	
09.92 → 08.97	ABU / AEA / AEE		246-080-010-002Z	N-H	T7: CL →
09.92 → 08.97	ABU / AEA / AEE		246-083-002-014G	SWP-D-C	T1: 6
09.92 → 08.97	ABU / AEA / AEE		246-086-001-002C	HLWP	T1: 3
09.92 → 08.97	ABU / AEA / AEE		246-086-001-007C	HLWP	T1: 3b; T3: X11-246-003-014; T7: CL →

1.6 (74 kW | 1.6 Liter)

07.95 → 08.97	AEK / AFT / AKS		246-069-056-001Z	N	
07.95 → 08.97	AEK / AFT / AKS		246-080-010-002Z	N-H	T7: CL →
07.95 → 08.97	AEK / AFT / AKS		246-083-002-014G	SWP-D-C	T1: 6
07.95 → 08.97	AEK / AFT / AKS		246-086-001-002C	HLWP	T1: 3
07.95 → 08.97	AEK / AFT / AKS		246-086-001-007C	HLWP	T1: 3b; T3: X11-246-003-014; T7: CL →

1.8 (55 kW | 1.8 Liter)

11.91 → 08.97	AAM		246-069-056-001Z	N	
11.91 → 08.97	AAM		246-080-010-002Z	N-H	T7: CL →
11.91 → 08.97	AAM		246-083-002-014G	SWP-D-C	T1: 6
11.91 → 08.97	AAM		246-086-001-002C	HLWP	T1: 3



			VDO		
Datum	Motorcode	Fahrgestell Nr.	Artikel Nr.	Artikelbez.	Information

VW**GOLF III (1H1)****1.8 (55 kW | 1.8 Liter)**

11.91 → 08.97	AAM		246-086-001-007C	HLWP	T1: 3b; T3: X11-246-003-014; T7: CL →
---------------	-----	--	------------------	------	---------------------------------------------

1.8 (66 kW | 1.8 Liter)

11.91 → 08.97	ABS / ACC / ADZ		246-069-056-001Z	N	
11.91 → 08.97	ABS / ACC / ADZ		246-080-010-002Z	N-H	T7: CL →
11.91 → 08.97	ABS / ACC / ADZ		246-083-002-014G	SWP-D-C	T1: 6
11.91 → 08.97	ABS / ACC / ADZ		246-086-001-002C	HLWP	T1: 3
11.91 → 08.97	ABS / ACC / ADZ		246-086-001-007C	HLWP	T1: 3b; T3: X11-246-003-014; T7: CL →

1.8 Syncro (1HX1) (66 kW | 1.8 Liter)

01.93 → 08.97	ABS / ADZ		246-069-056-001Z	N	
01.93 → 08.97	ABS / ADZ		246-080-010-002Z	N-H	T7: CL →
01.93 → 08.97	ABS / ADZ		246-083-002-014G	SWP-D-C	T1: 6
01.93 → 08.97	ABS / ADZ		246-086-001-002C	HLWP	T1: 3
01.93 → 08.97	ABS / ADZ		246-086-001-007C	HLWP	T1: 3b; T3: X11-246-003-014; T7: CL →

2.0 (85 kW | 2.0 Liter)

11.91 → 08.97	2E / ADY / AGG / AKR		246-069-056-001Z	N	
11.91 → 08.97	2E / ADY / AGG / AKR		246-080-010-002Z	N-H	T7: CL →
11.91 → 08.97	2E / ADY / AGG / AKR		246-083-002-014G	SWP-D-C	T1: 6
11.91 → 08.97	2E / ADY / AGG / AKR		246-086-001-002C	HLWP	T1: 3
11.91 → 08.97	2E / ADY / AGG / AKR		246-086-001-007C	HLWP	T1: 3b; T3: X11-246-003-014; T7: CL →

2.0 Syncro (1HX1) (85 kW | 2.0 Liter)

08.95 → 08.97	AGG		246-069-056-001Z	N	
08.95 → 08.97	AGG		246-080-010-002Z	N-H	T7: CL →
08.95 → 08.97	AGG		246-083-002-014G	SWP-D-C	T1: 6
08.95 → 08.97	AGG		246-086-001-002C	HLWP	T1: 3
08.95 → 08.97	AGG		246-086-001-007C	HLWP	T1: 3b; T3: X11-246-003-014; T7: CL →

2.0 GTI 16V (110 kW | 2.0 Liter)

08.92 → 08.97	ABF		246-069-056-001Z	N	
08.92 → 08.97	ABF		246-080-010-002Z	N-H	T7: CL →
08.92 → 08.97	ABF		246-083-002-014G	SWP-D-C	T1: 6
08.92 → 08.97	ABF		246-086-001-002C	HLWP	T1: 3
08.92 → 08.97	ABF		246-086-001-007C	HLWP	T1: 3b; T3: X11-246-003-014; T7: CL →



			VDO		
Datum	Motorcode	Fahrgestell Nr.	Artikel Nr.	Artikelbez.	Information

VW**GOLF III (1H1)****2.8 VR6 (128 kW | 2.8 Liter)**

01.92 → 08.97	AAA		246-069-056-001Z	N	
01.92 → 08.97	AAA		246-080-010-002Z	N-H	T7: CL →
01.92 → 08.97	AAA		246-083-002-014G	SWP-D-C	T1: 6
01.92 → 08.97	AAA		246-086-001-002C	HLWP	T1: 3
01.92 → 08.97	AAA		246-086-001-007C	HLWP	T1: 3b; T3: X11-246-003-014; T7: CL →

2.9 VR6 Syncro (1HX1) (140 kW | 2.9 Liter)

10.94 → 08.97	ABV		246-069-056-001Z	N	
10.94 → 08.97	ABV		246-080-010-002Z	N-H	T7: CL →
10.94 → 08.97	ABV		246-083-002-014G	SWP-D-C	T1: 6
10.94 → 08.97	ABV		246-086-001-002C	HLWP	T1: 3
10.94 → 08.97	ABV		246-086-001-007C	HLWP	T1: 3b; T3: X11-246-003-014; T7: CL →

1.9 SDI (47 kW | 1.9 Liter)

04.97 → 08.97	AEY		246-069-056-001Z	N	
04.97 → 08.97	AEY		246-080-010-002Z	N-H	T7: CL →
04.97 → 08.97	AEY		246-083-002-014G	SWP-D-C	T1: 6
04.97 → 08.97	AEY		246-086-001-002C	HLWP	T1: 3
04.97 → 08.97	AEY		246-086-001-007C	HLWP	T1: 3b; T3: X11-246-003-014; T7: CL →

1.9 D (48 kW | 1.9 Liter)

11.91 → 08.97	1Y		246-069-056-001Z	N	
11.91 → 08.97	1Y		246-080-010-002Z	N-H	T7: CL →
11.91 → 08.97	1Y		246-083-002-014G	SWP-D-C	T1: 6
11.91 → 08.97	1Y		246-086-001-002C	HLWP	T1: 3
11.91 → 08.97	1Y		246-086-001-007C	HLWP	T1: 3b; T3: X11-246-003-014; T7: CL →

1.9 TD,GTD (55 kW | 1.9 Liter)

11.91 → 08.97	AAZ		246-069-056-001Z	N	
11.91 → 08.97	AAZ		246-080-010-002Z	N-H	T7: CL →
11.91 → 08.97	AAZ		246-083-002-014G	SWP-D-C	T1: 6
11.91 → 08.97	AAZ		246-086-001-002C	HLWP	T1: 3
11.91 → 08.97	AAZ		246-086-001-007C	HLWP	T1: 3b; T3: X11-246-003-014; T7: CL →

1.9 TDI (66 kW | 1.9 Liter)

09.93 → 08.97	1Z / AHU / ALE		246-069-056-001Z	N	
09.93 → 08.97	1Z / AHU / ALE		246-080-010-002Z	N-H	T7: CL →
09.93 → 08.97	1Z / AHU / ALE		246-083-002-014G	SWP-D-C	T1: 6
09.93 → 08.97	1Z / AHU / ALE		246-086-001-002C	HLWP	T1: 3



			VDO		
Datum	Motorcode	Fahrgestell Nr.	Artikel Nr.	Artikelbez.	Information

VW**GOLF III (1H1)****1.9 TDI (66 kW | 1.9 Liter)**

09.93 → 08.97	1Z / AHU / ALE		246-086-001-007C	HLWP	T1: 3b; T3: X11-246-003-014; T7: CL →
---------------	----------------	--	------------------	------	---------------------------------------------

1.9 TDI Syncro (1HX1) (66 kW | 1.9 Liter)

08.95 → 08.97	1Z / AHU / ALE		246-069-056-001Z	N	
08.95 → 08.97	1Z / AHU / ALE		246-080-010-002Z	N-H	T7: CL →
05.96 → 08.97	1Z / AHU / ALE		246-083-002-014G	SWP-D-C	T1: 6
05.96 → 08.97	1Z / AHU / ALE		246-086-001-002C	HLWP	T1: 3
08.95 → 08.97	1Z / AHU / ALE		246-086-001-007C	HLWP	T1: 3b; T3: X11-246-003-014; T7: CL →

1.9 TDI (81 kW | 1.9 Liter)

04.96 → 08.97	AFN		246-069-056-001Z	N	
04.96 → 08.97	AFN		246-080-010-002Z	N-H	T7: CL →
04.96 → 08.97	AFN		246-083-002-014G	SWP-D-C	T1: 6
04.96 → 08.97	AFN		246-086-001-002C	HLWP	T1: 3
04.96 → 08.97	AFN		246-086-001-007C	HLWP	T1: 3b; T3: X11-246-003-014; T7: CL →

Citystromer (20 kW | 0.0 Liter)

11.94 → 08.97			246-069-056-001Z	N	
11.94 → 08.97			246-080-010-002Z	N-H	T7: CL →
11.94 → 08.97			246-086-001-007C	HLWP	T1: 3b; T3: X11-246-003-014; T7: CL →

GOLF III Variant (1H5)**1.4 (40 kW | 1.4 Liter)**

07.93 → 04.99	ABD		246-069-056-001Z	N	
07.93 → 04.99	ABD		246-080-010-002Z	N-H	T7: CL →
09.93 → 06.95	ABD		246-083-002-014G	SWP-D-C	T1: 6
07.93 → 04.99	ABD		246-086-001-007C	HLWP	T1: 3b; T3: X11-246-003-014; T7: CL →

1.4 (44 kW | 1.4 Liter)

07.93 → 04.99	ABD / AEX / APQ		246-069-056-001Z	N	
07.93 → 04.99	ABD / AEX / APQ		246-080-010-002Z	N-H	T7: CL →
07.93 → 04.99	ABD / AEX / APQ		246-086-001-007C	HLWP	T1: 3b; T3: X11-246-003-014; T7: CL →

1.6 (55 kW | 1.6 Liter)

07.93 → 12.97	ABU / AEA / AEE		246-082-008-021G	SWP-M-C	T1: 6
07.93 → 12.97	ABU / AEA / AEE		246-086-001-007C	HLWP	T1: 3b



			VDO		
Datum	Motorcode	Fahrgestell Nr.	Artikel Nr.	Artikelbez.	Information

VW**GOLF III Variant (1H5)****1.6 (74 kW | 1.6 Liter)**

07.94 → 04.99	AEK / AFT / AKS		246-069-056-001Z	N	
07.94 → 04.99	AEK / AFT / AKS		246-080-010-002Z	N-H	T7: CL →
10.94 → 12.95	AEK / AFT / AKS		246-083-002-014G	SWP-D-C	T1: 6
07.94 → 04.99	AEK / AFT / AKS		246-086-001-007C	HLWP	T1: 3b; T3: X11-246-003-014; T7: CL →

1.8 (55 kW | 1.8 Liter)

07.93 → 04.99	AAM / ANN		246-069-056-001Z	N	
07.93 → 04.99	AAM / ANN		246-080-010-002Z	N-H	T7: CL →
09.93 → 04.99	AAM / ANN		246-083-002-014G	SWP-D-C	T1: 6
07.93 → 04.99	AAM / ANN		246-086-001-007C	HLWP	T1: 3b; T3: X11-246-003-014; T7: CL →

1.8 (66 kW | 1.8 Liter)

07.93 → 04.99	ABS / ADZ / ANP		246-069-056-001Z	N	
07.93 → 04.99	ABS / ADZ / ANP		246-080-010-002Z	N-H	T7: CL →
09.93 → 04.99	ABS / ADZ / ANP		246-083-002-014G	SWP-D-C	T1: 6
07.93 → 04.99	ABS / ADZ / ANP		246-086-001-007C	HLWP	T1: 3b; T3: X11-246-003-014; T7: CL →

1.8 Syncro (66 kW | 1.8 Liter)

10.94 → 04.99	ADZ		246-069-056-001Z	N	
10.94 → 04.99	ADZ		246-080-010-002Z	N-H	T7: CL →
10.94 → 04.99	ADZ		246-083-002-014G	SWP-D-C	T1: 6
10.94 → 04.99	ADZ		246-086-001-002C	HLWP	T1: 3
10.94 → 04.99	ADZ		246-086-001-007C	HLWP	T1: 3b; T3: X11-246-003-014; T7: CL →

2.0 (85 kW | 2.0 Liter)

07.93 → 04.99	2E / ADY / AGG / AKR		246-069-056-001Z	N	
07.93 → 04.99	2E / ADY / AGG / AKR		246-080-010-002Z	N-H	T7: CL →
09.93 → 04.96	2E / ADY / AGG / AKR		246-083-002-014G	SWP-D-C	T1: 6
07.93 → 04.99	2E / ADY / AGG / AKR		246-086-001-007C	HLWP	T1: 3b; T3: X11-246-003-014; T7: CL →

2.0 Syncro (85 kW | 2.0 Liter)

08.95 → 04.99	AGG		246-069-056-001Z	N	
08.95 → 04.99	AGG		246-080-010-002Z	N-H	T7: CL →
08.95 → 04.99	AGG		246-086-001-007C	HLWP	T1: 3b; T3: X11-246-003-014; T7: CL →



			VDO		
Datum	Motorcode	Fahrgestell Nr.	Artikel Nr.	Artikelbez.	Information

VW**GOLF III Variant (1H5)****2.9 VR6 (140 kW | 2.9 Liter)**

10.94 → 04.99	ABV		246-069-056-001Z	N	
10.94 → 04.99	ABV		246-080-010-002Z	N-H	T7: CL →
07.95 → 04.99	ABV		246-083-002-014G	SWP-D-C	T1: 6
07.95 → 04.99	ABV		246-086-001-002C	HLWP	T1: 3
10.94 → 04.99	ABV		246-086-001-007C	HLWP	T1: 3b; T3: X11-246-003-014; T7: CL →

2.9 VR6 Syncro (140 kW | 2.9 Liter)

10.94 → 04.99	ABV		246-069-056-001Z	N	
10.94 → 04.99	ABV		246-080-010-002Z	N-H	T7: CL →
10.94 → 04.99	ABV		246-086-001-007C	HLWP	T1: 3b; T3: X11-246-003-014; T7: CL →

1.9 SDI (47 kW | 1.9 Liter)

04.97 → 04.99	AEY		246-069-056-001Z	N	
04.97 → 04.99	AEY		246-080-010-002Z	N-H	T7: CL →
04.97 → 04.99	AEY		246-086-001-007C	HLWP	T1: 3b; T3: X11-246-003-014; T7: CL →

1.9 D (48 kW | 1.9 Liter)

07.93 → 04.99	1Y		246-069-056-001Z	N	
07.93 → 04.99	1Y		246-080-010-002Z	N-H	T7: CL →
09.93 → 04.96	1Y		246-083-002-014G	SWP-D-C	T1: 6
07.93 → 04.99	1Y		246-086-001-007C	HLWP	T1: 3b; T3: X11-246-003-014; T7: CL →

1.9 TD (55 kW | 1.9 Liter)

07.93 → 04.99	AAZ		246-069-056-001Z	N	
07.93 → 04.99	AAZ		246-080-010-002Z	N-H	T7: CL →
09.93 → 04.99	AAZ		246-083-002-014G	SWP-D-C	T1: 6
07.93 → 04.99	AAZ		246-086-001-007C	HLWP	T1: 3b; T3: X11-246-003-014; T7: CL →

1.9 TDI (66 kW | 1.9 Liter)

03.94 → 04.99	1Z / AHU / ALE		246-069-056-001Z	N	
03.94 → 04.99	1Z / AHU / ALE		246-080-010-002Z	N-H	T7: CL →
03.94 → 07.96	1Z / AHU / ALE		246-083-002-014G	SWP-D-C	T1: 6
03.94 → 04.99	1Z / AHU / ALE		246-086-001-007C	HLWP	T1: 3b; T3: X11-246-003-014; T7: CL →

1.9 TDI Syncro (66 kW | 1.9 Liter)

07.95 → 04.99	1Z / AHU		246-069-056-001Z	N	
07.95 → 04.99	1Z / AHU		246-080-010-002Z	N-H	T7: CL →
07.95 → 07.96	1Z / AHU		246-083-002-014G	SWP-D-C	T1: 6



			VDO		
Datum	Motorcode	Fahrgestell Nr.	Artikel Nr.	Artikelbez.	Information

VW**GOLF III Variant (1H5)****1.9 TDI Syncro (66 kW | 1.9 Liter)**

07.95 → 07.96	1Z / AHU		246-086-001-002C	HLWP	T1: 3
07.95 → 04.99	1Z / AHU		246-086-001-007C	HLWP	T1: 3b; T3: X11-246-003-014; T7: CL →

1.9 TDI (81 kW | 1.9 Liter)

04.96 → 04.99	AFN		246-069-056-001Z	N	
04.96 → 04.99	AFN		246-080-010-002Z	N-H	T7: CL →
04.96 → 04.99	AFN		246-086-001-007C	HLWP	T1: 3b; T3: X11-246-003-014; T7: CL →

GOLF III Cabriolet (1E7)**1.6 (74 kW | 1.6 Liter)**

10.94 → 05.98	AEK / AFT / AKS		246-069-056-001Z	N	
10.94 → 05.98	AEK / AFT / AKS		246-080-010-002Z	N-H	
10.94 → 12.97	AEK / AFT / AKS		246-082-008-021G	SWP-M-C	T1: 6
10.94 → 12.97	AEK / AFT / AKS		246-086-001-002C	HLWP	T1: 3
10.94 → 05.98	AEK / AFT / AKS		246-086-001-007C	HLWP	T1: 3b; T3: X11-246-003-014

1.8 (55 kW | 1.8 Liter)

07.93 → 05.98	AAM		246-069-056-001Z	N	
07.93 → 05.98	AAM		246-080-010-002Z	N-H	
09.93 → 12.97	AAM		246-082-008-021G	SWP-M-C	T1: 6
09.93 → 12.97	AAM		246-086-001-002C	HLWP	T1: 3
07.93 → 05.98	AAM		246-086-001-007C	HLWP	T1: 3b; T3: X11-246-003-014

1.8 (66 kW | 1.8 Liter)

07.93 → 05.98	ABS / ADZ		246-069-056-001Z	N	
07.93 → 05.98	ABS / ADZ		246-080-010-002Z	N-H	
09.93 → 12.97	ABS / ADZ		246-082-008-021G	SWP-M-C	T1: 6
09.93 → 12.97	ABS / ADZ		246-086-001-002C	HLWP	T1: 3
07.93 → 05.98	ABS / ADZ		246-086-001-007C	HLWP	T1: 3b; T3: X11-246-003-014

2.0 (85 kW | 2.0 Liter)

07.93 → 05.98	2E / ADY / AGG / AKR		246-069-056-001Z	N	
07.93 → 05.98	2E / ADY / AGG / AKR		246-080-010-002Z	N-H	
09.93 → 12.97	2E / ADY / AGG / AKR		246-082-008-021G	SWP-M-C	T1: 6
09.93 → 12.97	2E / ADY / AGG / AKR		246-086-001-002C	HLWP	T1: 3
07.93 → 05.98	2E / ADY / AGG / AKR		246-086-001-007C	HLWP	T1: 3b; T3: X11-246-003-014



			VDO		
Datum	Motorcode	Fahrgestell Nr.	Artikel Nr.	Artikelbez.	Information

VW**GOLF III Cabriolet (1E7)****1.9 TDI (66 kW | 1.9 Liter)**

08.95 → 05.98	1Z / AHU		246-069-056-001Z	N	
08.95 → 05.98	1Z / AHU		246-080-010-002Z	N-H	
08.95 → 12.97	1Z / AHU		246-082-008-021G	SWP-M-C	T1: 6
08.95 → 12.97	1Z / AHU		246-086-001-002C	HLWP	T1: 3
08.95 → 05.98	1Z / AHU		246-086-001-007C	HLWP	T1: 3b; T3: X11-246-003-014

1.9 TDI (81 kW | 1.9 Liter)

07.96 → 05.98	AFN		246-069-056-001Z	N	
07.96 → 05.98	AFN		246-080-010-002Z	N-H	
10.96 → 12.97	AFN		246-082-008-021G	SWP-M-C	T1: 6
10.96 → 12.97	AFN		246-086-001-002C	HLWP	T1: 3
07.96 → 05.98	AFN		246-086-001-007C	HLWP	T1: 3b; T3: X11-246-003-014

GOLF IV (1J1)**1.4 16V (55 kW | 1.4 Liter)**

10.97 →	AHW / AKQ / APE / AXP / BCA		246-083-002-022G	SWP-D-C	T1: 3
10.97 →	AHW / AKQ / APE / AXP / BCA		246-086-001-002C	HLWP	T1: 3
08.97 →	AHW / AKQ / APE / AXP / BCA		246-086-001-007C	HLWP	T1: 3b; T3: X11-246-003-014

1.6 (74 kW | 1.6 Liter)

08.97 → 02.00	AEH / AKL / APF		246-083-002-022G	SWP-D-C	T1: 3
08.97 → 02.00	AEH / AKL / APF		246-086-001-007C	HLWP	T1: 3b; T3: X11-246-003-014

1.6 (75 kW | 1.6 Liter)

08.00 →	AVU		246-083-002-022G	SWP-D-C	T1: 3
08.00 →	AVU		246-086-001-002C	HLWP	T1: 3
08.00 →	AVU		246-086-001-007C	HLWP	T1: 3b; T3: X11-246-003-014

1.6 16V (77 kW | 1.6 Liter)

02.00 →	ATN / AUS / AZD / BCB		246-083-002-022G	SWP-D-C	T1: 3
02.00 →	ATN / AUS / AZD / BCB		246-086-001-007C	HLWP	T1: 3b; T3: X11-246-003-014





1.6 FSI (81 kW | 1.6 Liter)

01.02 →	BAD		246-083-002-022G	SWP-D-C	T1: 3
01.02 →	BAD		246-086-001-007C	HLWP	T1: 3b; T3: X11-246-003-014

1.8 (92 kW | 1.8 Liter)

10.97 → 05.99	AGN		246-083-002-022G	SWP-D-C	T1: 3
10.97 → 05.99	AGN		246-086-001-002C	HLWP	T1: 3
08.97 →	AGN		246-086-001-007C	HLWP	T1: 3b; T3: X11-246-003-014



			VDO		
Datum	Motorcode	Fahrgestell Nr.	Artikel Nr.	Artikelbez.	Information

VW**GOLF IV (1J1)****1.8 4motion (92 kW | 1.8 Liter)**

05.98 → 05.99	AGN		246-083-002-022G	SWP-D-C	T1: 3
05.98 → 05.99	AGN		246-086-001-002C	HLWP	T1: 3
05.98 →	AGN		246-086-001-007C	HLWP	T1: 3b; T3: X11-246-003-014

1.8 T (110 kW | 1.8 Liter)

10.97 → 05.99	AGU / ARZ / AUM		246-083-002-022G	SWP-D-C	T1: 3
10.97 → 05.99	AGU / ARZ / AUM		246-086-001-002C	HLWP	T1: 3
08.97 →	AGU / ARZ / AUM		246-086-001-007C	HLWP	T1: 3b; T3: X11-246-003-014

1.8 T GTI (132 kW | 1.8 Liter)

08.01 →	AUQ		246-083-002-022G	SWP-D-C	T1: 3
08.01 →	AUQ		246-086-001-007C	HLWP	T1: 3b; T3: X11-246-003-014

2.0 (85 kW | 2.0 Liter)

08.98 →	APK / AQY / AZG / AZJ		246-083-002-022G	SWP-D-C	T1: 3
08.98 →	APK / AQY / AZG / AZJ		246-086-001-002C	HLWP	T1: 3
07.98 →	APK / AQY / AZG / AZJ		246-086-001-007C	HLWP	T1: 3b; T3: X11-246-003-014

2.0 4motion (85 kW | 2.0 Liter)

10.00 →	AZH / AZJ		246-083-002-022G	SWP-D-C	T1: 3
10.00 →	AZH / AZJ		246-086-001-007C	HLWP	T1: 3b; T3: X11-246-003-014

2.3 V5 (110 kW | 2.3 Liter)

08.97 → 10.00	AGZ		246-083-002-022G	SWP-D-C	T1: 3
08.97 → 10.00	AGZ		246-086-001-007C	HLWP	T1: 3b; T3: X11-246-003-014

2.3 V5 4motion (110 kW | 2.3 Liter)

12.98 → 05.99	AGZ		246-083-002-022G	SWP-D-C	T1: 3
12.98 → 05.99	AGZ		246-086-001-002C	HLWP	T1: 3
12.98 → 10.00	AGZ		246-086-001-007C	HLWP	T1: 3b; T3: X11-246-003-014

2.3 V5 (125 kW | 2.3 Liter)

10.00 →	AQN		246-083-002-022G	SWP-D-C	T1: 3
10.00 →	AQN		246-086-001-007C	HLWP	T1: 3b; T3: X11-246-003-014





2.3 V5 4motion (125 kW | 2.3 Liter)

10.00 →	AQN		246-083-002-022G	SWP-D-C	T1: 3
10.00 →	AQN		246-086-001-007C	HLWP	T1: 3b; T3: X11-246-003-014

2.8 V6 4motion (150 kW | 2.8 Liter)

03.99 →	AQP / AUE / BDE		246-083-002-022G	SWP-D-C	T1: 3
03.99 →	AQP / AUE / BDE		246-086-001-007C	HLWP	T1: 3b; T3: X11-246-003-014



			VDO		
Datum	Motorcode	Fahrgestell Nr.	Artikel Nr.	Artikelbez.	Information

VW**GOLF IV (1J1)**

3.2 R32 4motion (177 kW 3.2 Liter)					
09.02 →	BFH		246-082-008-025G	SWP-M-C	T1: 3
09.02 →	BFH		246-086-001-007C	HLWP	T1: 3b
1.9 SDI (50 kW 1.9 Liter)					
10.97 →	AGP / AQM		246-083-002-022G	SWP-D-C	T1: 3
10.97 →	AGP / AQM		246-086-001-002C	HLWP	T1: 3
08.97 →	AGP / AQM		246-086-001-007C	HLWP	T1: 3b; T3: X11-246-003-014
1.9 TDI (66 kW 1.9 Liter)					
08.97 → 06.01	AGR / ALH		246-083-002-022G	SWP-D-C	T1: 3
08.97 → 06.01	AGR / ALH		246-086-001-007C	HLWP	T1: 3b; T3: X11-246-003-014
1.9 TDI 4motion (66 kW 1.9 Liter)					
04.98 → 05.99	AGR / ALH		246-083-002-022G	SWP-D-C	T1: 3
04.98 → 05.99	AGR / ALH		246-086-001-002C	HLWP	T1: 3
04.98 → 06.01	AGR / ALH		246-086-001-007C	HLWP	T1: 3b; T3: X11-246-003-014
1.9 TDI (74 kW 1.9 Liter)					
09.00 →	ATD / AXR		246-083-002-022G	SWP-D-C	T1: 3
09.00 →	ATD / AXR		246-086-001-007C	HLWP	T1: 3b; T3: X11-246-003-014
1.9 TDI 4motion (74 kW 1.9 Liter)					
09.00 →	ATD		246-083-002-022G	SWP-D-C	T1: 3
09.00 →	ATD		246-086-001-007C	HLWP	T1: 3b; T3: X11-246-003-014
1.9 TDI (81 kW 1.9 Liter)					
08.97 → 05.04	AHF / ASV		246-083-002-022G	SWP-D-C	T1: 3
08.97 → 05.04	AHF / ASV		246-086-001-007C	HLWP	T1: 3b; T3: X11-246-003-014
1.9 TDI (85 kW 1.9 Liter)					
12.98 → 06.01	AJM / AUJ		246-083-002-022G	SWP-D-C	T1: 3
12.98 → 06.01	AJM / AUJ		246-086-001-002C	HLWP	T1: 3
12.98 → 06.01	AJM / AUJ		246-086-001-007C	HLWP	T1: 3b; T3: X11-246-003-014
1.9 TDI 4motion (85 kW 1.9 Liter)					
09.99 → 06.01	AJM / AUJ		246-083-002-022G	SWP-D-C	T1: 3
09.99 → 06.01	AJM / AUJ		246-086-001-007C	HLWP	T1: 3b; T3: X11-246-003-014
1.9 TDI (96 kW 1.9 Liter)					
11.00 →	ASZ		246-083-002-022G	SWP-D-C	T1: 3
11.00 →	ASZ		246-086-001-007C	HLWP	T1: 3b; T3: X11-246-003-014



			VDO		
Datum	Motorcode	Fahrgestell Nr.	Artikel Nr.	Artikelbez.	Information

VW**GOLF IV (1J1)****1.9 TDI 4motion (96 kW | 1.9 Liter)**

11.00 →	ASZ		246-083-002-022G	SWP-D-C	T1: 3
11.00 →	ASZ		246-086-001-007C	HLWP	T1: 3b; T3: X11-246-003-014

1.9 TDI (110 kW | 1.9 Liter)

05.00 →	ARL		246-083-002-022G	SWP-D-C	T1: 3
05.00 →	ARL		246-086-001-007C	HLWP	T1: 3b; T3: X11-246-003-014

1.9 TDI 4motion (110 kW | 1.9 Liter)

02.00 →	ARL		246-083-002-022G	SWP-D-C	T1: 3
02.00 →	ARL		246-086-001-007C	HLWP	T1: 3b; T3: X11-246-003-014

GOLF IV Variant (1J5)**1.4 16V (55 kW | 1.4 Liter)**

05.99 →	AHW / AKQ / APE / AXP / BCA		246-082-008-021G	SWP-M-C	T1: 6
05.99 →	AHW / AKQ / APE / AXP / BCA		246-083-002-022G	SWP-D-C	T1: 3
05.99 →	AHW / AKQ / APE / AXP / BCA		246-086-001-007C	HLWP	T1: 3b

1.6 (74 kW | 1.6 Liter)

05.99 → 02.00	AEH / AKL / APF		246-082-008-021G	SWP-M-C	T1: 6
05.99 → 02.00	AEH / AKL / APF		246-083-002-022G	SWP-D-C	T1: 3
05.99 → 02.00	AEH / AKL / APF		246-086-001-007C	HLWP	T1: 3b

1.6 (75 kW | 1.6 Liter)

08.00 →	AVU		246-083-002-022G	SWP-D-C	T1: 3
08.00 →	AVU		246-086-001-002C	HLWP	T1: 3

1.6 16V (77 kW | 1.6 Liter)

02.00 →	ATN / AUS / AZD / BCB		246-082-008-021G	SWP-M-C	T1: 6
02.00 →	ATN / AUS / AZD / BCB		246-083-002-022G	SWP-D-C	T1: 3
02.00 →	ATN / AUS / AZD / BCB		246-086-001-007C	HLWP	T1: 3b

1.6 FSI (81 kW | 1.6 Liter)

01.02 →	BAD		246-082-008-021G	SWP-M-C	T1: 6
01.02 →	BAD		246-083-002-022G	SWP-D-C	T1: 3
01.02 →	BAD		246-086-001-007C	HLWP	T1: 3b

1.8 4motion (92 kW | 1.8 Liter)

05.99 →	AGN		246-083-002-022G	SWP-D-C	T1: 3
05.99 →	AGN		246-086-001-002C	HLWP	T1: 3

1.8 T (110 kW | 1.8 Liter)

05.00 →	AGU / AUM		246-082-008-021G	SWP-M-C	T1: 6
05.00 →	AGU / AUM		246-083-002-022G	SWP-D-C	T1: 3
05.00 →	AGU / AUM		246-086-001-007C	HLWP	T1: 3b

2.0 (85 kW | 2.0 Liter)

05.99 →	APK / AQY / AZJ		246-082-008-021G	SWP-M-C	T1: 6
05.99 →	APK / AQY / AZJ		246-083-002-022G	SWP-D-C	T1: 3
05.99 →	APK / AQY / AZJ		246-086-001-007C	HLWP	T1: 3b



			VDO		
Datum	Motorcode	Fahrgestell Nr.	Artikel Nr.	Artikelbez.	Information

VW**GOLF IV Variant (1J5)**

2.0 4motion (85 kW 2.0 Liter)					
10.00 →	AZH / AZJ		246-082-008-021G	SWP-M-C	T1: 6
10.00 →	AZH / AZJ		246-083-002-022G	SWP-D-C	T1: 3
10.00 →	AZH / AZJ		246-086-001-007C	HLWP	T1: 3b
2.0 Bi-Fuel (85 kW 2.0 Liter)					
02.02 →	BEH		246-082-008-021G	SWP-M-C	T1: 6
02.02 →	BEH		246-083-002-022G	SWP-D-C	T1: 3
02.02 →	BEH		246-086-001-007C	HLWP	T1: 3b
2.3 V5 (110 kW 2.3 Liter)					
05.99 →	AGZ		246-083-002-022G	SWP-D-C	T1: 3
05.99 →	AGZ		246-086-001-002C	HLWP	T1: 3
2.3 V5 4motion (110 kW 2.3 Liter)					
05.99 →	AGZ		246-083-002-022G	SWP-D-C	T1: 3
05.99 →	AGZ		246-086-001-002C	HLWP	T1: 3
2.3 V5 (125 kW 2.3 Liter)					
10.00 →	AQN		246-082-008-021G	SWP-M-C	T1: 6
10.00 →	AQN		246-083-002-022G	SWP-D-C	T1: 3
10.00 →	AQN		246-086-001-007C	HLWP	T1: 3b
2.3 V5 4motion (125 kW 2.3 Liter)					
10.00 →	AQN		246-082-008-021G	SWP-M-C	T1: 6
10.00 →	AQN		246-083-002-022G	SWP-D-C	T1: 3
10.00 →	AQN		246-086-001-007C	HLWP	T1: 3b
2.8 V6 4motion (150 kW 2.8 Liter)					
05.99 →	AQP / AUE / BDE		246-083-002-022G	SWP-D-C	T1: 3
05.99 →	AQP / AUE / BDE		246-086-001-002C	HLWP	T1: 3
1.9 SDI (50 kW 1.9 Liter)					
05.99 →	AGP / AQM		246-082-008-021G	SWP-M-C	T1: 6
05.99 →	AGP / AQM		246-083-002-022G	SWP-D-C	T1: 3
05.99 →	AGP / AQM		246-086-001-007C	HLWP	T1: 3b
1.9 TDI (66 kW 1.9 Liter)					
05.99 → 06.01	AGR / ALH		246-082-008-021G	SWP-M-C	T1: 6
05.99 → 06.01	AGR / ALH		246-083-002-022G	SWP-D-C	T1: 3
05.99 → 06.01	AGR / ALH		246-086-001-007C	HLWP	T1: 3b
1.9 TDI 4motion (66 kW 1.9 Liter)					
05.99 → 06.01	AGR / ALH		246-082-008-021G	SWP-M-C	T1: 6
05.99 → 06.01	AGR / ALH		246-083-002-022G	SWP-D-C	T1: 3
05.99 → 06.01	AGR / ALH		246-086-001-007C	HLWP	T1: 3b
1.9 TDI (74 kW 1.9 Liter)					
09.00 →	ATD / AXR		246-083-002-022G	SWP-D-C	T1: 3
09.00 →	ATD / AXR		246-086-001-002C	HLWP	T1: 3
1.9 TDI 4motion (74 kW 1.9 Liter)					
09.00 →	ATD		246-082-008-021G	SWP-M-C	T1: 6
09.00 →	ATD		246-083-002-022G	SWP-D-C	T1: 3
09.00 →	ATD		246-086-001-007C	HLWP	T1: 3b



			VDO		
Datum	Motorcode	Fahrgestell Nr.	Artikel Nr.	Artikelbez.	Information

VW**GOLF IV Variant (1J5)****1.9 TDI (81 kW | 1.9 Liter)**

05.99 → 06.01	AHF / ASV		246-082-008-021G	SWP-M-C	T1: 6
05.99 → 06.01	AHF / ASV		246-083-002-022G	SWP-D-C	T1: 3
05.99 → 06.01	AHF / ASV		246-086-001-007C	HLWP	T1: 3b

1.9 TDI (85 kW | 1.9 Liter)

08.99 → 06.01	AJM / AUJ		246-082-008-021G	SWP-M-C	T1: 6
08.99 → 06.01	AJM / AUJ		246-083-002-022G	SWP-D-C	T1: 3
08.99 → 06.01	AJM / AUJ		246-086-001-007C	HLWP	T1: 3b

1.9 TDI 4motion (85 kW | 1.9 Liter)

09.99 → 06.01	AJM		246-083-002-022G	SWP-D-C	T1: 3
09.99 → 06.01	AJM		246-086-001-002C	HLWP	T1: 3

1.9 TDI (96 kW | 1.9 Liter)

11.00 →	ASZ		246-082-008-021G	SWP-M-C	T1: 6
11.00 →	ASZ		246-083-002-022G	SWP-D-C	T1: 3
11.00 →	ASZ		246-086-001-007C	HLWP	T1: 3b

1.9 TDI 4motion (96 kW | 1.9 Liter)

11.00 →	ASZ		246-082-008-021G	SWP-M-C	T1: 6
11.00 →	ASZ		246-083-002-022G	SWP-D-C	T1: 3
11.00 →	ASZ		246-086-001-007C	HLWP	T1: 3b

GOLF IV Cabriolet (1E7)**1.6 (74 kW | 1.6 Liter)**

06.98 →	AFT / AKS		246-069-056-001Z	N	
06.98 →	AFT / AKS		246-086-001-007C	HLWP	T1: 3b; T3: X11-246-003-014

1.8 (55 kW | 1.8 Liter)

06.98 →	AAM / ANN		246-069-056-001Z	N	
06.98 → 10.98	AAM / ANN	→ X - 017 970	246-082-008-021G	SWP-M-C	T1: 6
10.98 →	AAM / ANN	X - 017 971 →	246-082-008-025G	SWP-M-C	T1: 3
06.98 →	AAM / ANN		246-086-001-002C	HLWP	T1: 3
06.98 →	AAM / ANN		246-086-001-007C	HLWP	T1: 3b; T3: X11-246-003-014

1.8 (66 kW | 1.8 Liter)

06.98 →	ADZ / ANP		246-069-056-001Z	N	
06.98 → 10.98	ADZ / ANP	→ X - 017 970	246-082-008-021G	SWP-M-C	T1: 6
10.98 →	ADZ / ANP	X - 017 971 →	246-082-008-025G	SWP-M-C	T1: 3
06.98 →	ADZ / ANP		246-086-001-002C	HLWP	T1: 3
06.98 →	ADZ / ANP		246-086-001-007C	HLWP	T1: 3b; T3: X11-246-003-014

2.0 (85 kW | 2.0 Liter)

06.98 →	AGG / AKR / ATU / AWF / AWG		246-069-056-001Z	N	
06.98 →	AGG / AKR / ATU / AWF / AWG		246-086-001-007C	HLWP	T1: 3b; T3: X11-246-003-014



			VDO		
Datum	Motorcode	Fahrgestell Nr.	Artikel Nr.	Artikelbez.	Information

VW**GOLF IV Cabriolet (1E7)****1.9 TDI (66 kW | 1.9 Liter)**

06.98 →	AHU / ALE		246-069-056-001Z	N	
06.98 →	AHU / ALE		246-086-001-007C	HLWP	T1: 3b; T3: X11-246-003-014

1.9 TDI (81 kW | 1.9 Liter)

06.98 →	AFN / AVG		246-069-056-001Z	N	
06.98 → 10.98	AFN / AVG	→ X - 017 970	246-082-008-021G	SWP-M-C	T1: 6
10.98 →	AFN / AVG	X - 017 971 →	246-082-008-025G	SWP-M-C	T1: 3
06.98 →	AFN / AVG		246-086-001-002C	HLWP	T1: 3
06.98 →	AFN / AVG		246-086-001-007C	HLWP	T1: 3b; T3: X11-246-003-014

GOLF V (1K1)**1.4 16V (55 kW | 1.4 Liter)**

10.03 →	BCA	1J-3-450 001 →; 1J-3P066 446 →; 1J-3D015 733 →	246-082-008-025G	SWP-M-C	T1: 3
10.03 →	BCA		246-083-002-022G	SWP-D-C	T1: 3
10.03 →	BCA		246-086-001-007C	HLWP	T1: 3b

1.4 FSI (66 kW | 1.4 Liter)

10.03 →	BKG	1J-3-450 001 →; 1J-3P066 446 →; 1J-3D015 733 →	246-082-008-025G	SWP-M-C	T1: 3
10.03 →	BKG		246-083-002-022G	SWP-D-C	T1: 3
10.03 →	BKG		246-086-001-007C	HLWP	T1: 3b

1.4 TSI (125 kW | 1.4 Liter)

11.05 →	BLG	1J-3P066 446 →; 1J-3-450 001 →; 1J-3D015 733 →	246-082-008-025G	SWP-M-C	T1: 3
11.05 →	BLG		246-083-002-022G	SWP-D-C	T1: 3
11.05 →	BLG		246-086-001-007C	HLWP	T1: 3b

1.6 (75 kW | 1.6 Liter)

01.04 →	BGU	1J-3-450 001 →; 1J-3P066 446 →; 1J-3D015 733 →	246-082-008-025G	SWP-M-C	T1: 3
01.04 →	BGU		246-083-002-022G	SWP-D-C	T1: 3
01.04 →	BGU		246-086-001-007C	HLWP	T1: 3b

1.6 FSI (85 kW | 1.6 Liter)

10.03 →	BAG	1J-3-450 001 →; 1J-3P066 446 →; 1J-3D015 733 →	246-082-008-025G	SWP-M-C	T1: 3
10.03 →	BAG		246-083-002-022G	SWP-D-C	T1: 3
10.03 →	BAG		246-086-001-007C	HLWP	T1: 3b



			VDO		
Datum	Motorcode	Fahrgestell Nr.	Artikel Nr.	Artikelbez.	Information

VW**GOLF V (1K1)****2.0 FSI (110 kW | 2.0 Liter)**

01.04 →	AXW	1J-3-450 001 →; 1J-3P066 446 →; 1J-3D015 733 →	246-082-008-025G	SWP-M-C	T1: 3
01.04 →	AXW		246-083-002-022G	SWP-D-C	T1: 3
01.04 →	AXW		246-086-001-007C	HLWP	T1: 3b

2.0 FSI 4motion (110 kW | 2.0 Liter)

08.04 →	AXW	1J-3P066 446 →; 1J-3-450 001 →; 1J-3D015 733 →	246-082-008-025G	SWP-M-C	T1: 3
08.04 →	AXW		246-083-002-022G	SWP-D-C	T1: 3
08.04 →	AXW		246-086-001-007C	HLWP	T1: 3b

2.0 GTI (147 kW | 2.0 Liter)

10.04 →	AXX / BWA	1J-3P066 446 →; 1J-3-450 001 →; 1J-3D015 733 →	246-082-008-025G	SWP-M-C	T1: 3
10.04 →	AXX / BWA		246-083-002-022G	SWP-D-C	T1: 3
10.04 →	AXX / BWA		246-086-001-007C	HLWP	T1: 3b

3.2 R32 4motion (184 kW | 3.2 Liter)

11.05 →	BUB	1J-3P066 446 →; 1J-3-450 001 →; 1J-3D015 733 →	246-082-008-025G	SWP-M-C	T1: 3
11.05 →	BUB		246-083-002-022G	SWP-D-C	T1: 3
11.05 →	BUB		246-086-001-007C	HLWP	T1: 3b

1.9 TDI (66 kW | 1.9 Liter)

05.04 →	BRU	1J-3-450 001 →; 1J-3P066 446 →; 1J-3D015 733 →	246-082-008-025G	SWP-M-C	T1: 3
05.04 →	BRU		246-083-002-022G	SWP-D-C	T1: 3
05.04 →	BRU		246-086-001-007C	HLWP	T1: 3b

1.9 TDI (77 kW | 1.9 Liter)

10.03 →	BKC	1J-3-450 001 →; 1J-3P066 446 →; 1J-3D015 733 →	246-082-008-025G	SWP-M-C	T1: 3
10.03 →	BKC		246-083-002-022G	SWP-D-C	T1: 3
10.03 →	BKC		246-086-001-007C	HLWP	T1: 3b

1.9 TDI 4motion (77 kW | 1.9 Liter)

08.04 →	BKC	1J-3P066 446 →; 1J-3-450 001 →; 1J-3D015 733 →	246-082-008-025G	SWP-M-C	T1: 3
08.04 →	BKC		246-083-002-022G	SWP-D-C	T1: 3
08.04 →	BKC		246-086-001-007C	HLWP	T1: 3b



			VDO		
Datum	Motorcode	Fahrgestell Nr.	Artikel Nr.	Artikelbez.	Information

VW**GOLF V (1K1)****2.0 SDI (55 kW | 2.0 Liter)**

01.04 →	BDK	1J-3-450 001 →; 1J-3P066 446 →; 1J-3D015 733 →	246-082-008-025G	SWP-M-C	T1: 3
01.04 →	BDK		246-083-002-022G	SWP-D-C	T1: 3
01.04 →	BDK		246-086-001-007C	HLWP	T1: 3b

2.0 TDI (103 kW | 2.0 Liter)

10.03 →	BKD	1J-3-450 001 →; 1J-3P066 446 →; 1J-3D015 733 →	246-082-008-025G	SWP-M-C	T1: 3
10.03 →	BKD		246-083-002-022G	SWP-D-C	T1: 3
10.03 →	BKD		246-086-001-007C	HLWP	T1: 3b

2.0 TDI 4motion (103 kW | 2.0 Liter)

08.04 →	BKD	1J-3P066 446 →; 1J-3-450 001 →; 1J-3D015 733 →	246-082-008-025G	SWP-M-C	T1: 3
08.04 →	BKD		246-083-002-022G	SWP-D-C	T1: 3
08.04 →	BKD		246-086-001-007C	HLWP	T1: 3b

2.0 GTD (125 kW | 2.0 Liter)

11.05 →	BMN	1J-3P066 446 →; 1J-3-450 001 →; 1J-3D015 733 →	246-082-008-025G	SWP-M-C	T1: 3
11.05 →	BMN		246-083-002-022G	SWP-D-C	T1: 3
11.05 →	BMN		246-086-001-007C	HLWP	T1: 3b

GOLF V PLUS (5M1)**1.4 16V (55 kW | 1.4 Liter)**

01.05 →	BCA		246-083-002-022G	SWP-D-C	T1: 3
01.05 →	BCA		246-086-001-007C	HLWP	T1: 3b

1.6 (75 kW | 1.6 Liter)

05.05 →	BSE / BSF		246-083-002-022G	SWP-D-C	T1: 3
05.05 →	BSE / BSF		246-086-001-007C	HLWP	T1: 3b

1.6 FSI (85 kW | 1.6 Liter)

01.05 →	BLF		246-083-002-022G	SWP-D-C	T1: 3
01.05 →	BLF		246-086-001-007C	HLWP	T1: 3b

2.0 FSI (110 kW | 2.0 Liter)

05.05 →	BLR / BLY / BVY / BVZ		246-083-002-022G	SWP-D-C	T1: 3
05.05 →	BLR / BLY / BVY / BVZ		246-086-001-007C	HLWP	T1: 3b

1.9 TDI (66 kW | 1.9 Liter)

05.05 →	BRU		246-083-002-022G	SWP-D-C	T1: 3
05.05 →	BRU		246-086-001-007C	HLWP	T1: 3b

1.9 TDI (77 kW | 1.9 Liter)

01.05 →	BKC		246-083-002-022G	SWP-D-C	T1: 3
01.05 →	BKC		246-086-001-007C	HLWP	T1: 3b



			VDO		
Datum	Motorcode	Fahrgestell Nr.	Artikel Nr.	Artikelbez.	Information

VW**GOLF V PLUS (5M1)****2.0 TDI (103 kW | 2.0 Liter)**

01.05 →	BKD		246-083-002-022G	SWP-D-C	T1: 3
01.05 →	BKD		246-086-001-007C	HLWP	T1: 3b

ILTIS (183)**1.7 (55 kW | 1.7 Liter)**

03.79 → 12.88	WL / YX		246-082-008-014C	SWP-M-C	T1: 1
---------------	---------	--	------------------	---------	-------

1.6 TD (51 kW | 1.6 Liter)

08.87 → 12.88	1C		246-082-008-014C	SWP-M-C	T1: 1
---------------	----	--	------------------	---------	-------

JETTA I (16)**1.1 (37 kW | 1.1 Liter)**

08.78 → 02.84	FA / GG		246-075-021-006C	SWP-M-G	T1: 1; T2: B
08.80 → 07.83	FA / GG		246-082-008-014C	SWP-M-C	T1: 1
08.78 → 02.84	FA / GG		246-086-001-007C	HLWP	T1: 3b; T3: X11-246-003-014

1.3 (44 kW | 1.3 Liter)

08.79 → 02.84	GF		246-075-021-006C	SWP-M-G	T1: 1; T2: B
08.79 → 07.83	GF		246-082-008-014C	SWP-M-C	T1: 1
08.79 → 02.84	GF		246-086-001-007C	HLWP	T1: 3b; T3: X11-246-003-014

1.5 (51 kW | 1.5 Liter)

08.78 → 02.84	JB		246-075-021-006C	SWP-M-G	T1: 1; T2: B
08.78 → 07.83	JB		246-082-008-014C	SWP-M-C	T1: 1
08.78 → 02.84	JB		246-086-001-007C	HLWP	T1: 3b; T3: X11-246-003-014

1.6 (63 kW | 1.6 Liter)

08.78 → 02.84	FR		246-075-021-006C	SWP-M-G	T1: 1; T2: B
08.80 → 07.83	FR		246-082-008-014C	SWP-M-C	T1: 1
08.78 → 02.84	FR		246-086-001-007C	HLWP	T1: 3b; T3: X11-246-003-014

1.6 GLI (81 kW | 1.6 Liter)

08.78 → 07.82	EG		246-075-021-006C	SWP-M-G	T1: 1; T2: B
08.78 → 07.82	EG		246-082-008-014C	SWP-M-C	T1: 1
08.78 → 07.82	EG		246-086-001-007C	HLWP	T1: 3b; T3: X11-246-003-014

1.8 (82 kW | 1.8 Liter)

08.82 → 07.83	DX / JJ		246-082-008-014C	SWP-M-C	T1: 1
08.82 → 02.84	DX / JJ		246-086-001-007C	HLWP	T1: 3b; T3: X11-246-003-014



			VDO		
Datum	Motorcode	Fahrgestell Nr.	Artikel Nr.	Artikelbez.	Information

VW**JETTA I (16)****1.5 D (37 kW | 1.5 Liter)**

08.78 → 07.80	CK		246-075-021-006C	SWP-M-G	T1: 1; T2: B
08.78 → 07.80	CK		246-086-001-007C	HLWP	T1: 3b; T3: X11-246-003-014

1.6 D (40 kW | 1.6 Liter)

08.80 → 02.84	CR / JK		246-075-021-006C	SWP-M-G	T1: 1; T2: B
08.80 → 07.83	CR / JK		246-082-008-014C	SWP-M-C	T1: 1
08.80 → 02.84	CR / JK		246-086-001-007C	HLWP	T1: 3b; T3: X11-246-003-014

1.6 TD (51 kW | 1.6 Liter)

03.82 → 02.84	CY		246-082-008-014C	SWP-M-C	T1: 1
03.82 → 02.84	CY		246-086-001-007C	HLWP	T1: 3b; T3: X11-246-003-014

JETTA II (19E, 1G2)**1.3 (40 kW | 1.3 Liter)**

01.84 → 06.87	HK / MH		246-082-008-014C	SWP-M-C	T1: 1
01.84 → 06.87	HK / MH		246-086-001-007C	HLWP	T1: 3b; T3: X11-246-003-014; T7: C →

1.3 KAT (40 kW | 1.3 Liter)

08.88 → 07.90	2G / MH / NZ		246-082-008-014C	SWP-M-C	T1: 1
06.87 → 12.91	2G / MH / NZ		246-086-001-007C	HLWP	T1: 3b; T3: X11-246-003-014; T7: C →

1.3 (44 kW | 1.3 Liter)

01.84 → 10.86	GT		246-082-008-014C	SWP-M-C	T1: 1
01.84 → 10.86	GT		246-086-001-007C	HLWP	T1: 3b; T3: X11-246-003-014; T7: C →

1.6 (51 kW | 1.6 Liter)

10.86 → 10.91	PN		246-082-008-014C	SWP-M-C	T1: 1
10.86 → 10.91	PN		246-086-001-007C	HLWP	T1: 3b; T3: X11-246-003-014; T7: C →

1.6 (53 kW | 1.6 Liter)

08.86 → 10.91	RF		246-082-008-014C	SWP-M-C	T1: 1
03.86 → 10.91	RF		246-086-001-007C	HLWP	T1: 3b; T3: X11-246-003-014; T7: C →



			VDO		
Datum	Motorcode	Fahrgestell Nr.	Artikel Nr.	Artikelbez.	Information

VW**JETTA II (19E, 1G2)****1.6 (55 kW | 1.6 Liter)**

01.84 → 07.91	ABN / EZ / HM		246-082-008-014C	SWP-M-C	T1: 1
01.84 → 07.92	ABN / EZ / HM		246-086-001-007C	HLWP	T1: 3b; T3: X11-246-003-014; T7: C →

1.8 (62 kW | 1.8 Liter)

08.88 → 01.90	RH		246-082-008-014C	SWP-M-C	T1: 1
08.86 → 01.90	RH		246-086-001-007C	HLWP	T1: 3b; T3: X11-246-003-014; T7: C →

1.8 (66 kW | 1.8 Liter)

08.88 → 10.91	GU / GX / HV		246-082-008-014C	SWP-M-C	T1: 1
08.87 → 10.91	GU / GX / HV		246-083-002-014G	SWP-D-C	T1: 6
08.84 → 10.91	GU / GX / HV		246-086-001-007C	HLWP	T1: 3b; T3: X11-246-003-014; T7: C →

1.8 KAT (66 kW | 1.8 Liter)

08.87 → 10.91	GX / RP		246-082-008-014C	SWP-M-C	T1: 1
08.87 → 10.91	GX / RP		246-086-001-007C	HLWP	T1: 3b; T3: X11-246-003-014; T7: C →

1.8 Syncro (66 kW | 1.8 Liter)

08.87 → 07.88	RP		246-083-002-014G	SWP-D-C	T1: 6
08.87 → 12.88	RP		246-086-001-007C	HLWP	T1: 3b; T3: X11-246-003-014; T7: C →

1.8 Syncro (72 kW | 1.8 Liter)

08.88 → 07.91	1P		246-083-002-014G	SWP-D-C	T1: 6
08.88 → 07.91	1P		246-086-001-007C	HLWP	T1: 3b; T3: X11-246-003-014; T7: C →

1.8 (79 kW | 1.8 Liter)

08.85 → 10.87	RD		246-086-001-007C	HLWP	T1: 3b; T3: X11-246-003-014; T7: C →
---------------	----	--	------------------	------	--------------------------------------------

1.8 KAT (79 kW | 1.8 Liter)

01.87 → 10.91	PF		246-082-008-014C	SWP-M-C	T1: 1
01.87 → 10.91	PF		246-086-001-007C	HLWP	T1: 3b; T3: X11-246-003-014; T7: C →

1.8 (82 kW | 1.8 Liter)

01.84 → 07.88	EV / GZ / PB		246-082-008-014C	SWP-M-C	T1: 1
01.84 → 10.91	EV / GZ / PB		246-086-001-007C	HLWP	T1: 3b; T3: X11-246-003-014; T7: C →



			VDO		
Datum	Motorcode	Fahrgestell Nr.	Artikel Nr.	Artikelbez.	Information

VW**JETTA II (19E, 1G2)****1.8 16V (95 kW | 1.8 Liter)**

08.86 → 10.91	PL		246-082-008-014C	SWP-M-C	T1: 1
08.86 → 10.91	PL		246-086-001-007C	HLWP	T1: 3b; T3: X11-246-003-014; T7: C →

1.8 16V (102 kW | 1.8 Liter)

06.87 → 12.89	KR		246-082-008-014C	SWP-M-C	T1: 1
06.87 → 12.89	KR		246-086-001-007C	HLWP	T1: 3b; T3: X11-246-003-014; T7: C →

1.6 D (40 kW | 1.6 Liter)

01.84 → 10.91	JP / ME		246-082-008-014C	SWP-M-C	T1: 1
01.84 → 10.91	JP / ME		246-086-001-007C	HLWP	T1: 3b; T3: X11-246-003-014; T7: C →

1.6 TD (44 kW | 1.6 Liter)

01.90 → 10.91	1V		246-086-001-007C	HLWP	T1: 3b; T3: X11-246-003-014; T7: C →
---------------	----	--	------------------	------	--------------------------------------------

1.6 TD (51 kW | 1.6 Liter)

08.84 → 10.91	JR / MF		246-082-008-014C	SWP-M-C	T1: 1
01.84 → 10.91	JR / MF		246-086-001-007C	HLWP	T1: 3b; T3: X11-246-003-014; T7: C →

1.6 TD (59 kW | 1.6 Liter)

04.89 → 10.91	RA / SB		246-082-008-014C	SWP-M-C	T1: 1
04.89 → 10.91	RA / SB		246-086-001-007C	HLWP	T1: 3b; T3: X11-246-003-014; T7: C →

JETTA III (1K2)**1.6 (75 kW | 1.6 Liter)**

10.05 →	BSE / BSF		246-086-001-007C	HLWP	T1: 3b
---------	-----------	--	------------------	------	--------

1.6 FSI (85 kW | 1.6 Liter)

09.05 →	BLF		246-086-001-007C	HLWP	T1: 3b
---------	-----	--	------------------	------	--------

2.0 FSI (110 kW | 2.0 Liter)

08.05 →	BLR / BLY		246-086-001-007C	HLWP	T1: 3b
---------	-----------	--	------------------	------	--------

1.9 TDI (77 kW | 1.9 Liter)

09.05 →	BKC / BLS		246-086-001-007C	HLWP	T1: 3b
---------	-----------	--	------------------	------	--------

2.0 TDI (103 kW | 2.0 Liter)

08.05 →	BKD / BMM		246-086-001-007C	HLWP	T1: 3b
---------	-----------	--	------------------	------	--------



			VDO		
Datum	Motorcode	Fahrgestell Nr.	Artikel Nr.	Artikelbez.	Information

VW**KAEFER****1200 1.2 (11) (25 kW | 1.2 Liter)**

01.60 → 12.85	D	F114 2000 001 →	246-075-021-006C	SWP-M-G	T1: 1; T2: B
---------------	---	-----------------	------------------	---------	--------------

KARMANN GHIA Cabriolet (14, 34)**1200 (25 kW | 1.2 Liter)**

01.60 → 12.64	D	F114 2000 001 →	246-075-021-006C	SWP-M-G	T1: 1; T2: B
---------------	---	-----------------	------------------	---------	--------------

K 70 (48)**1.8 (74 kW | 1.8 Liter)**

08.73 → 10.74	DC		246-075-021-006C	SWP-M-G	T1: 1; T2: B
---------------	----	--	------------------	---------	--------------

LUPO (6X1, 6E1)**1.0 (37 kW | 1.0 Liter)**

10.98 →	AER / AHT / ALD / ALL / ANV / AUC		246-083-002-022G	SWP-D-C	T1: 3
---------	-----------------------------------	--	------------------	---------	-------

09.98 →	AER / AHT / ALD / ALL / ANV / AUC		246-086-001-007C	HLWP	T1: 3b; T3: X11-246-003-014
---------	-----------------------------------	--	------------------	------	--------------------------------

1.4 (44 kW | 1.4 Liter)

10.00 →	AUD		246-083-002-022G	SWP-D-C	T1: 3
---------	-----	--	------------------	---------	-------

10.00 →	AUD		246-086-001-007C	HLWP	T1: 3b; T3: X11-246-003-014
---------	-----	--	------------------	------	--------------------------------

1.4 16V (55 kW | 1.4 Liter)

10.98 →	AHW / AKQ / APE / AUA / BBY		246-083-002-022G	SWP-D-C	T1: 3
---------	-----------------------------	--	------------------	---------	-------

09.98 →	AHW / AKQ / APE / AUA / BBY		246-086-001-007C	HLWP	T1: 3b; T3: X11-246-003-014
---------	-----------------------------	--	------------------	------	--------------------------------

1.4 16V (74 kW | 1.4 Liter)

08.99 →	AFK / ANM / AQQ / AUB		246-083-002-022G	SWP-D-C	T1: 3
---------	-----------------------	--	------------------	---------	-------

08.99 →	AFK / ANM / AQQ / AUB		246-086-001-007C	HLWP	T1: 3b; T3: X11-246-003-014
---------	-----------------------	--	------------------	------	--------------------------------

1.4 FSI (77 kW | 1.4 Liter)

02.01 →	ARR		246-083-002-022G	SWP-D-C	T1: 3
---------	-----	--	------------------	---------	-------

02.01 →	ARR		246-086-001-007C	HLWP	T1: 3b; T3: X11-246-003-014
---------	-----	--	------------------	------	--------------------------------

1.6 GTI (92 kW | 1.6 Liter)

09.00 →	AVY		246-083-002-022G	SWP-D-C	T1: 3
---------	-----	--	------------------	---------	-------

09.00 →	AVY		246-086-001-007C	HLWP	T1: 3b; T3: X11-246-003-014
---------	-----	--	------------------	------	--------------------------------

1.2 TDI 3L (45 kW | 1.2 Liter)

07.99 →	ANY / AYZ		246-083-002-022G	SWP-D-C	T1: 3
---------	-----------	--	------------------	---------	-------

07.99 →	ANY / AYZ		246-086-001-007C	HLWP	T1: 3b; T3: X11-246-003-014
---------	-----------	--	------------------	------	--------------------------------



			VDO		
Datum	Motorcode	Fahrgestell Nr.	Artikel Nr.	Artikelbez.	Information

VW**LUPO (6X1, 6E1)****1.4 TDI (55 kW | 1.4 Liter)**

05.99 →	AMF		246-083-002-022G	SWP-D-C	T1: 3
01.99 →	AMF		246-086-001-007C	HLWP	T1: 3b; T3: X11-246-003-014

1.7 SDI (44 kW | 1.7 Liter)

10.98 →	AKU		246-083-002-022G	SWP-D-C	T1: 3
09.98 →	AKU		246-086-001-007C	HLWP	T1: 3b; T3: X11-246-003-014

NEW BEETLE (9C1, 1C1)**1.4 (55 kW | 1.4 Liter)**

11.01 →	BCA		246-086-001-007C	HLWP	T1: 3b
---------	-----	--	------------------	------	--------

1.6 (74 kW | 1.6 Liter)

10.99 → 09.00	AWH		246-086-001-007C	HLWP	T1: 3b
---------------	-----	--	------------------	------	--------

1.6 (75 kW | 1.6 Liter)

09.00 →	AYD		246-086-001-007C	HLWP	T1: 3b
---------	-----	--	------------------	------	--------

1.8 T (110 kW | 1.8 Liter)

10.99 →	APH / AVC / AWU / AWV		246-086-001-007C	HLWP	T1: 3b
---------	-----------------------	--	------------------	------	--------

2.0 (85 kW | 2.0 Liter)

11.98 →	AEG / APK / AQY / AZG		246-082-008-025G	SWP-M-C	T1: 3
---------	-----------------------	--	------------------	---------	-------

11.98 →	AEG / APK / AQY / AZG		246-086-001-002C	HLWP	T1: 3
---------	-----------------------	--	------------------	------	-------

2.3 V5 (125 kW | 2.3 Liter)

10.00 →	AQN		246-086-001-007C	HLWP	T1: 3b
---------	-----	--	------------------	------	--------

RSI 3.2 (1C9) (165 kW | 3.2 Liter)

04.00 →	AXJ		246-086-001-007C	HLWP	T1: 3b
---------	-----	--	------------------	------	--------

1.9 TDI (66 kW | 1.9 Liter)

11.98 → 02.01	ALH		246-082-008-025G	SWP-M-C	T1: 3
---------------	-----	--	------------------	---------	-------

11.98 → 02.01	ALH		246-086-001-002C	HLWP	T1: 3
---------------	-----	--	------------------	------	-------

1.9 TDI (74 kW | 1.9 Liter)

02.01 →	ATD		246-086-001-007C	HLWP	T1: 3b
---------	-----	--	------------------	------	--------

NEW BEETLE Cabriolet (1Y7)**1.4 (55 kW | 1.4 Liter)**

01.03 →	BCA		246-082-008-025G	SWP-M-C	T1: 3
---------	-----	--	------------------	---------	-------

01.03 →	BCA		246-086-001-007C	HLWP	T1: 3b
---------	-----	--	------------------	------	--------

1.6 (75 kW | 1.6 Liter)

01.03 →	BFS		246-082-008-025G	SWP-M-C	T1: 3
---------	-----	--	------------------	---------	-------

01.03 →	BFS		246-086-001-007C	HLWP	T1: 3b
---------	-----	--	------------------	------	--------

1.8 T (110 kW | 1.8 Liter)

01.04 →	AWU		246-082-008-025G	SWP-M-C	T1: 3
---------	-----	--	------------------	---------	-------

01.04 →	AWU		246-086-001-007C	HLWP	T1: 3b
---------	-----	--	------------------	------	--------



			VDO		
Datum	Motorcode	Fahrgestell Nr.	Artikel Nr.	Artikelbez.	Information

VW**NEW BEETLE Cabriolet (1Y7)****2.0 (85 kW | 2.0 Liter)**

01.03 →	AZJ / BDC / BGD		246-082-008-025G	SWP-M-C	T1: 3
01.03 →	AZJ / BDC / BGD		246-086-001-007C	HLWP	T1: 3b
1.9 TDI (74 kW 1.9 Liter)					
03.03 →	AXR		246-082-008-025G	SWP-M-C	T1: 3
03.03 →	AXR		246-086-001-007C	HLWP	T1: 3b

PASSAT (32)**1.3 (40 kW | 1.3 Liter)**

05.73 → 12.76	FY	→ 327 2088 829	246-075-021-006C	SWP-M-G	T1: 1; T2: B
12.76 → 07.80	FY	327 2088 830 →	246-082-008-014C	SWP-M-C	T1: 1

1.3 (40 kW | 1.3 Liter)

05.73 → 01.78	ZA		246-075-021-006C	SWP-M-G	T1: 1; T2: B
05.73 → 01.78	ZA		246-082-008-014C	SWP-M-C	T1: 1

1.3 (44 kW | 1.3 Liter)

05.73 → 12.76	ZF	→ 327 2088 829	246-075-021-006C	SWP-M-G	T1: 1; T2: B
12.76 → 01.78	ZF	327 2088 830 →	246-082-008-014C	SWP-M-C	T1: 1

1.5 (55 kW | 1.5 Liter)

07.73 → 12.75	YJ / ZB		246-075-021-006C	SWP-M-G	T1: 1; T2: B
---------------	---------	--	------------------	---------	--------------

1.5 (63 kW | 1.5 Liter)

05.73 → 12.75	ZC		246-075-021-006C	SWP-M-G	T1: 1; T2: B
---------------	----	--	------------------	---------	--------------

1.6 (53 kW | 1.6 Liter)

08.75 → 07.80	FS		246-082-008-014C	SWP-M-C	T1: 1
---------------	----	--	------------------	---------	-------

1.6 (63 kW | 1.6 Liter)

09.75 → 12.76	YP	→ 327 2088 829	246-075-021-006C	SWP-M-G	T1: 1; T2: B
12.76 → 07.80	YP	327 2088 830 →	246-082-008-014C	SWP-M-C	T1: 1

1.5 D (37 kW | 1.5 Liter)

08.77 → 07.80	CK		246-082-008-014C	SWP-M-C	T1: 1
---------------	----	--	------------------	---------	-------

PASSAT Variant (33)**1.3 (40 kW | 1.3 Liter)**

05.73 → 07.80	FY		246-075-021-006C	SWP-M-G	T1: 1; T2: B
---------------	----	--	------------------	---------	--------------

1.3 (40 kW | 1.3 Liter)

05.73 → 01.78	ZA		246-075-021-006C	SWP-M-G	T1: 1; T2: B
---------------	----	--	------------------	---------	--------------

1.3 (44 kW | 1.3 Liter)

10.73 → 01.78	ZF		246-075-021-006C	SWP-M-G	T1: 1; T2: B
---------------	----	--	------------------	---------	--------------

1.5 (55 kW | 1.5 Liter)

10.73 → 08.75	YJ / ZB		246-075-021-006C	SWP-M-G	T1: 1; T2: B
---------------	---------	--	------------------	---------	--------------

1.5 (63 kW | 1.5 Liter)

10.73 → 12.75	ZC		246-075-021-006C	SWP-M-G	T1: 1; T2: B
---------------	----	--	------------------	---------	--------------

1.6 (55 kW | 1.6 Liter)

08.77 → 07.80	YN		246-082-008-014C	SWP-M-C	T1: 1
---------------	----	--	------------------	---------	-------



			VDO		
Datum	Motorcode	Fahrgestell Nr.	Artikel Nr.	Artikelbez.	Information

VW**PASSAT Variant (33)****1.6 (63 kW | 1.6 Liter)**

08.75 → 07.80	YP		246-075-021-006C	SWP-M-G	T1: 1; T2: B
---------------	----	--	------------------	---------	--------------

1.5 D (37 kW | 1.5 Liter)

02.77 → 07.80	CK		246-075-021-006C	SWP-M-G	T1: 1; T2: B
---------------	----	--	------------------	---------	--------------

PASSAT (32B)**1.3 (40 kW | 1.3 Liter)**

08.82 → 07.83	FY		246-082-008-014C	SWP-M-C	T1: 1
---------------	----	--	------------------	---------	-------

08.80 → 07.83	FY		246-086-001-007C	HLWP	T1: 3b; T3: X11-246-003-014
---------------	----	--	------------------	------	--------------------------------

1.3 (44 kW | 1.3 Liter)

01.85 → 07.86	FZ		246-082-008-014C	SWP-M-C	T1: 1
---------------	----	--	------------------	---------	-------

08.80 → 07.86	FZ		246-086-001-007C	HLWP	T1: 3b; T3: X11-246-003-014
---------------	----	--	------------------	------	--------------------------------

1.3 (44 kW | 1.3 Liter)

08.80 → 07.86	EP / EU		246-082-008-014C	SWP-M-C	T1: 1
---------------	---------	--	------------------	---------	-------

08.80 → 07.86	EP / EU		246-086-001-007C	HLWP	T1: 3b
---------------	---------	--	------------------	------	--------

1.6 (51 kW | 1.6 Liter)

08.87 → 03.88	PP		246-082-008-014C	SWP-M-C	T1: 1
---------------	----	--	------------------	---------	-------

08.87 → 03.88	PP		246-086-001-007C	HLWP	T1: 3b; T3: X11-246-003-014
---------------	----	--	------------------	------	--------------------------------

1.6 (53 kW | 1.6 Liter)

02.86 → 03.88	RF / RL		246-082-008-014C	SWP-M-C	T1: 1
---------------	---------	--	------------------	---------	-------

02.86 → 03.88	RF / RL		246-086-001-007C	HLWP	T1: 3b; T3: X11-246-003-014
---------------	---------	--	------------------	------	--------------------------------

1.6 (55 kW | 1.6 Liter)

08.80 → 03.88	WV / YN		246-086-001-007C	HLWP	T1: 3b; T3: X11-246-003-014
---------------	---------	--	------------------	------	--------------------------------

08.80 → 03.88	DT		246-082-008-014C	SWP-M-C	T1: 1
---------------	----	--	------------------	---------	-------

08.80 → 03.88	DT		246-086-001-007C	HLWP	T1: 3b
---------------	----	--	------------------	------	--------

1.6 (63 kW | 1.6 Liter)

08.82 → 12.82	YP		246-082-008-014C	SWP-M-C	T1: 1
---------------	----	--	------------------	---------	-------

01.81 → 02.83	YP		246-086-001-007C	HLWP	T1: 3b; T3: X11-246-003-014
---------------	----	--	------------------	------	--------------------------------

1.8 (64 kW | 1.8 Liter)





05.86 → 03.88	RM		246-082-008-014C	SWP-M-C	T1: 1
---------------	----	--	------------------	---------	-------

05.86 → 03.88	RM		246-086-001-007C	HLWP	T1: 3b; T3: X11-246-003-014
---------------	----	--	------------------	------	--------------------------------

1.8 (66 kW | 1.8 Liter)

01.83 → 03.88	DS / JN		246-086-001-007C	HLWP	T1: 3b; T3: X11-246-003-014
---------------	---------	--	------------------	------	--------------------------------



			VDO		
Datum	Motorcode	Fahrgestell Nr.	Artikel Nr.	Artikelbez.	Information

VW**PASSAT (32B)****1.8 (82 kW | 1.8 Liter)**

12.83 → 03.88	DZ		246-086-001-007C	HLWP	T1: 3b; T3: X11-246-003-014
---------------	----	--	------------------	------	--------------------------------

1.9 (85 kW | 1.9 Liter)

08.82 → 07.83	WN		246-082-008-014C	SWP-M-C	T1: 1
01.81 → 07.83	WN		246-086-001-007C	HLWP	T1: 3b; T3: X11-246-003-014

2.0 (85 kW | 2.0 Liter)

01.85 → 03.88	HP / JS		246-082-008-014C	SWP-M-C	T1: 1
08.83 → 03.88	HP / JS		246-086-001-007C	HLWP	T1: 3b; T3: X11-246-003-014

2.1 (85 kW | 2.1 Liter)

01.81 → 07.83	WE		246-086-001-007C	HLWP	T1: 3b; T3: X11-246-003-014
---------------	----	--	------------------	------	--------------------------------

2.2 (85 kW | 2.2 Liter)

08.85 → 03.88	KX		246-082-008-014C	SWP-M-C	T1: 1
08.85 → 03.88	KX		246-086-001-007C	HLWP	T1: 3b; T3: X11-246-003-014

2.2 (100 kW | 2.2 Liter)

01.85 → 03.88	KV		246-086-001-007C	HLWP	T1: 3b; T3: X11-246-003-014
---------------	----	--	------------------	------	--------------------------------

1.6 D (40 kW | 1.6 Liter)

01.85 → 03.88	CR / JK		246-082-008-014C	SWP-M-C	T1: 1
08.80 → 03.88	CR / JK		246-086-001-007C	HLWP	T1: 3b; T3: X11-246-003-014

1.6 TD (51 kW | 1.6 Liter)

04.82 → 03.88	CY		246-086-001-007C	HLWP	T1: 3b; T3: X11-246-003-014
---------------	----	--	------------------	------	--------------------------------

1.6 TD (59 kW | 1.6 Liter)

05.86 → 03.88	RA		246-086-001-007C	HLWP	T1: 3b; T3: X11-246-003-014
---------------	----	--	------------------	------	--------------------------------

PASSAT Stufenheck (32B)**1.6 (51 kW | 1.6 Liter)**

08.87 → 03.88	PP		246-082-008-014C	SWP-M-C	T1: 1
08.87 → 03.88	PP		246-086-001-007C	HLWP	T1: 3b; T3: X11-246-003-014

1.6 (53 kW | 1.6 Liter)

01.85 → 03.88	RF / RL		246-086-001-007C	HLWP	T1: 3b; T3: X11-246-003-014
---------------	---------	--	------------------	------	--------------------------------

1.6 (55 kW | 1.6 Liter)

01.85 → 03.88	DT		246-082-008-014C	SWP-M-C	T1: 1
01.85 → 03.88	DT		246-086-001-007C	HLWP	T1: 3b; T3: X11-246-003-014



			VDO		
Datum	Motorcode	Fahrgestell Nr.	Artikel Nr.	Artikelbez.	Information

VW**PASSAT Stufenheck (32B)****1.8 (64 kW | 1.8 Liter)**

05.86 → 03.88	RM		246-086-001-007C	HLWP	T1: 3b; T3: X11-246-003-014
---------------	----	--	------------------	------	--------------------------------

1.8 (66 kW | 1.8 Liter)

01.85 → 03.88	DS / JN		246-082-008-014C	SWP-M-C	T1: 1
01.85 → 03.88	DS / JN		246-086-001-007C	HLWP	T1: 3b; T3: X11-246-003-014

2.2 (85 kW | 2.2 Liter)

07.86 → 03.88	KX		246-082-008-014C	SWP-M-C	T1: 1
01.85 → 03.88	KX		246-086-001-007C	HLWP	T1: 3b; T3: X11-246-003-014

1.6 TD (51 kW | 1.6 Liter)

01.85 → 03.88	CY		246-082-008-014C	SWP-M-C	T1: 1
01.85 → 03.88	CY		246-086-001-007C	HLWP	T1: 3b; T3: X11-246-003-014

PASSAT Variant (32B)**1.3 (40 kW | 1.3 Liter)**

08.81 → 07.83	FY		246-082-008-014C	SWP-M-C	T1: 1
---------------	----	--	------------------	---------	-------

1.3 (44 kW | 1.3 Liter)

08.83 → 07.86	FZ		246-082-008-014C	SWP-M-C	T1: 1
---------------	----	--	------------------	---------	-------

1.3 (44 kW | 1.3 Liter)

08.80 → 07.86	EP / EU		246-082-008-014C	SWP-M-C	T1: 1
08.80 → 07.86	EP / EU		246-086-001-007C	HLWP	T1: 3b

1.6 (51 kW | 1.6 Liter)

08.87 → 03.88	PP		246-086-001-007C	HLWP	T1: 3b; T3: X11-246-003-014
---------------	----	--	------------------	------	--------------------------------

1.6 (53 kW | 1.6 Liter)

02.86 → 03.88	RL		246-082-008-014C	SWP-M-C	T1: 1
03.87 → 03.88	RL		246-086-001-007C	HLWP	T1: 3b; T3: X11-246-003-014

1.6 (55 kW | 1.6 Liter)

08.81 → 07.86	WV / YN		246-082-008-014C	SWP-M-C	T1: 1
03.87 → 03.88	WV / YN		246-086-001-007C	HLWP	T1: 3b; T3: X11-246-003-014

1.6 (55 kW | 1.6 Liter)

08.80 → 03.88	DT		246-082-008-014C	SWP-M-C	T1: 1
08.80 → 03.88	DT		246-086-001-007C	HLWP	T1: 3b

1.6 (63 kW | 1.6 Liter)

08.81 → 12.82	YP		246-082-008-014C	SWP-M-C	T1: 1
---------------	----	--	------------------	---------	-------



			VDO		
Datum	Motorcode	Fahrgestell Nr.	Artikel Nr.	Artikelbez.	Information

VW**PASSAT Variant (32B)****1.8 (64 kW | 1.8 Liter)**

05.86 → 03.88	RM	→ H - 175 000	246-082-008-014C	SWP-M-C	T1: 1
06.87 → 03.88	RM	H - 175 001 →	246-083-002-006G	SWP-D-C	T1: 1
03.87 → 03.88	RM		246-086-001-007C	HLWP	T1: 3b; T3: X11-246-003-014

1.8 (66 kW | 1.8 Liter)

08.84 → 07.86	DS / JN		246-082-008-014C	SWP-M-C	T1: 1
03.87 → 03.88	DS / JN		246-086-001-007C	HLWP	T1: 3b; T3: X11-246-003-014

1.8 Syncro (66 kW | 1.8 Liter)

03.87 → 03.88	DS / JN		246-086-001-007C	HLWP	T1: 3b; T3: X11-246-003-014
---------------	---------	--	------------------	------	--------------------------------

1.8 (82 kW | 1.8 Liter)

03.87 → 03.88	DZ		246-086-001-007C	HLWP	T1: 3b; T3: X11-246-003-014
---------------	----	--	------------------	------	--------------------------------

1.9 (85 kW | 1.9 Liter)

08.81 → 07.83	WN		246-082-008-014C	SWP-M-C	T1: 1
---------------	----	--	------------------	---------	-------

2.0 (85 kW | 2.0 Liter)

08.84 → 03.88	HP / JS		246-082-008-014C	SWP-M-C	T1: 1
03.87 → 03.88	HP / JS		246-086-001-007C	HLWP	T1: 3b; T3: X11-246-003-014

2.0 Syncro (85 kW | 2.0 Liter)

08.84 → 06.87	JS	→ H - 175 000	246-082-008-014C	SWP-M-C	T1: 1
06.87 → 03.88	JS	H - 175 001 →	246-083-002-006G	SWP-D-C	T1: 1
03.87 → 03.88	JS		246-086-001-007C	HLWP	T1: 3b; T3: X11-246-003-014

2.1 (85 kW | 2.1 Liter)

01.81 → 07.83	WE		246-082-008-014C	SWP-M-C	T1: 1
01.81 → 07.83	WE		246-086-001-007C	HLWP	T1: 3b

2.2 (85 kW | 2.2 Liter)

08.85 → 03.88	KX		246-082-008-014C	SWP-M-C	T1: 1
03.87 → 03.88	KX		246-086-001-007C	HLWP	T1: 3b; T3: X11-246-003-014

2.2 Syncro (88 kW | 2.2 Liter)

08.85 → 06.87	JT	→ H - 175 000	246-082-008-014C	SWP-M-C	T1: 1
06.87 → 03.88	JT	H - 175 001 →	246-083-002-006G	SWP-D-C	T1: 1
03.87 → 03.88	JT		246-086-001-007C	HLWP	T1: 3b; T3: X11-246-003-014

2.2 (100 kW | 2.2 Liter)

01.85 → 03.88	KV		246-082-008-014C	SWP-M-C	T1: 1
03.87 → 03.88	KV		246-086-001-007C	HLWP	T1: 3b; T3: X11-246-003-014



			VDO		
Datum	Motorcode	Fahrgestell Nr.	Artikel Nr.	Artikelbez.	Information

VW**PASSAT Variant (32B)****1.6 D (40 kW | 1.6 Liter)**

08.81 → 03.88	CR / JK		246-082-008-014C	SWP-M-C	T1: 1
03.87 → 03.88	CR / JK		246-086-001-007C	HLWP	T1: 3b; T3: X11-246-003-014

1.6 TD (51 kW | 1.6 Liter)

04.82 → 03.88	CY		246-082-008-014C	SWP-M-C	T1: 1
03.87 → 03.88	CY		246-086-001-007C	HLWP	T1: 3b; T3: X11-246-003-014

PASSAT (3A2, 35I)**1.6 (53 kW | 1.6 Liter)**

02.88 → 09.91	1F / EZ		246-069-056-001Z	N	
04.88 → 09.91	1F / EZ		246-080-010-002Z	N-H	T7: CL →
08.88 → 07.90	1F / EZ		246-082-008-014C	SWP-M-C	T1: 1
08.88 → 07.90	1F / EZ		246-086-001-007C	HLWP	T1: 3b; T3: X11-246-003-014

1.6 (55 kW | 1.6 Liter)

02.88 → 12.88	EZ		246-069-056-001Z	N	
04.88 → 12.88	EZ		246-080-010-002Z	N-H	T7: CL →
02.88 → 12.88	EZ	→ M - 400 000	246-082-008-014C	SWP-M-C	T1: 1
04.88 → 12.88	EZ	→ M - 400 000	246-086-001-007C	HLWP	T1: 3b; T3: X11-246-003-014

1.6 (74 kW | 1.6 Liter)

10.94 → 08.96	AEK / AFT		246-069-056-001Z	N	
10.94 → 08.96	AEK / AFT		246-080-010-002Z	N-H	T7: CL →
10.94 → 11.95	AEK / AFT		246-082-008-021G	SWP-M-C	T1: 6
10.94 → 11.95	AEK / AFT		246-083-002-014G	SWP-D-C	T1: 6
10.94 → 11.95	AEK / AFT		246-086-001-002C	HLWP	T1: 3
10.94 → 08.96	AEK / AFT		246-086-001-007C	HLWP	T1: 3b; T3: X11-246-003-014

1.8 (55 kW | 1.8 Liter)

08.90 → 08.96	AAM		246-069-056-001Z	N	
08.90 → 08.96	AAM		246-080-010-002Z	N-H	T7: CL →
08.90 → 08.91	AAM	→ M - 400 000	246-082-008-014C	SWP-M-C	T1: 1
08.91 → 08.96	AAM	N - 000 001 →	246-082-008-021G	SWP-M-C	T1: 6
10.93 → 08.96	AAM		246-083-002-014G	SWP-D-C	T1: 6
08.91 → 08.96	AAM	N - 000 001 →	246-086-001-002C	HLWP	T1: 3
08.90 → 08.91	AAM	→ M - 400 000	246-086-001-007C	HLWP	T1: 3b; T3: X11-246-003-014

1.8 (66 kW | 1.8 Liter)

02.88 → 08.96	ABS / ADZ / RP		246-069-056-001Z	N	
04.88 → 08.96	ABS / ADZ / RP		246-080-010-002Z	N-H	T7: CL →
04.88 → 08.91	ABS / ADZ / RP	→ M - 400 000	246-082-008-014C	SWP-M-C	T1: 1
08.91 → 09.94	ABS / ADZ / RP	N - 000 001 →	246-082-008-021G	SWP-M-C	T1: 6



			VDO		
Datum	Motorcode	Fahrgestell Nr.	Artikel Nr.	Artikelbez.	Information

VW**PASSAT (3A2, 35I)****1.8 (66 kW | 1.8 Liter)**

10.93 → 09.94	ABS / ADZ / RP		246-083-002-014G	SWP-D-C	T1: 6
08.91 → 09.94	ABS / ADZ / RP	N - 000 001 →	246-086-001-002C	HLWP	T1: 3
04.88 → 08.91	ABS / ADZ / RP	→ M - 400 000	246-086-001-007C	HLWP	T1: 3b; T3: X11-246-003-014

1.8 (79 kW | 1.8 Liter)

04.88 → 07.93	PF		246-069-056-001Z	N	
04.88 → 07.93	PF		246-080-010-002Z	N-H	T7: CL →
04.88 → 07.90	PF		246-082-008-014C	SWP-M-C	T1: 1
04.88 → 07.90	PF		246-086-001-007C	HLWP	T1: 3b; T3: X11-246-003-014

1.8 (82 kW | 1.8 Liter)

04.88 → 07.92	PB		246-069-056-001Z	N	
04.88 → 07.92	PB		246-080-010-002Z	N-H	T7: CL →
04.88 → 07.90	PB		246-082-008-014C	SWP-M-C	T1: 1
04.88 → 07.90	PB		246-086-001-007C	HLWP	T1: 3b; T3: X11-246-003-014

1.8 16V (100 kW | 1.8 Liter)

04.88 → 12.89	KR		246-069-056-001Z	N	
04.88 → 12.89	KR		246-080-010-002Z	N-H	T7: CL →
04.88 → 12.89	KR	→ M - 400 000	246-082-008-014C	SWP-M-C	T1: 1
04.88 → 12.89	KR	→ M - 400 000	246-086-001-007C	HLWP	T1: 3b; T3: X11-246-003-014

1.8 G60 Syncro (118 kW | 1.8 Liter)

08.88 → 08.96	PG		246-069-056-001Z	N	
08.88 → 08.96	PG		246-080-010-002Z	N-H	T7: CL →
08.90 → 08.91	PG	→ M - 500 000	246-082-008-014C	SWP-M-C	T1: 1
08.91 → 10.93	PG	N - 000 001 →	246-082-008-021G	SWP-M-C	T1: 6
08.91 → 10.93	PG	N - 000 001 →	246-086-001-002C	HLWP	T1: 3
08.91 → 08.96	PG		246-086-001-007C	HLWP	T1: 3b; T3: X11-246-003-014

2.0 (79 kW | 2.0 Liter)

03.95 → 08.96	AEP		246-069-056-001Z	N	
03.95 → 08.96	AEP		246-080-010-002Z	N-H	T7: CL →
03.95 → 08.96	AEP		246-082-008-021G	SWP-M-C	T1: 6
03.95 → 08.96	AEP		246-083-002-014G	SWP-D-C	T1: 6
03.95 → 08.96	AEP		246-086-001-002C	HLWP	T1: 3
03.95 → 08.96	AEP		246-086-001-007C	HLWP	T1: 3b; T3: X11-246-003-014

2.0 (85 kW | 2.0 Liter)

02.90 → 08.96	2E / ADY / AGG		246-069-056-001Z	N	
02.90 → 08.96	2E / ADY / AGG		246-080-010-002Z	N-H	T7: CL →
02.90 → 09.91	2E / ADY / AGG	→ M - 500 000; → M - 400 000	246-082-008-014C	SWP-M-C	T1: 1
08.91 → 09.94	2E / ADY / AGG	N - 000 001 →	246-082-008-021G	SWP-M-C	T1: 6



			VDO		
Datum	Motorcode	Fahrgestell Nr.	Artikel Nr.	Artikelbez.	Information

VW**PASSAT (3A2, 35I)****2.0 (85 kW | 2.0 Liter)**

10.93 → 09.94	2E / ADY / AGG		246-083-002-014G	SWP-D-C	T1: 6
08.91 → 09.94	2E / ADY / AGG	N - 000 001 →	246-086-001-002C	HLWP	T1: 3
03.90 → 08.91	2E / ADY / AGG	→ M - 400 000	246-086-001-007C	HLWP	T1: 3b; T3: X11-246-003-014

2.0 Syncro (85 kW | 2.0 Liter)

10.90 → 08.96	2E / ADY / AGG		246-069-056-001Z	N	
10.90 → 08.96	2E / ADY / AGG		246-080-010-002Z	N-H	T7: CL →
08.91 → 08.96	2E / ADY / AGG		246-086-001-007C	HLWP	T1: 3b; T3: X11-246-003-014

2.0 16V (100 kW | 2.0 Liter)

08.88 → 09.93	9A		246-069-056-001Z	N	
08.88 → 09.93	9A		246-080-010-002Z	N-H	T7: CL →
08.88 → 08.91	9A	→ M - 400 000	246-082-008-014C	SWP-M-C	T1: 1
08.91 → 09.91	9A	N - 000 001 →	246-082-008-021G	SWP-M-C	T1: 6
08.91 → 09.91	9A	N - 000 001 →	246-086-001-002C	HLWP	T1: 3
08.88 → 08.91	9A	→ M - 400 000	246-086-001-007C	HLWP	T1: 3b; T3: X11-246-003-014

2.0 16V (110 kW | 2.0 Liter)

01.94 → 08.96	ABF		246-069-056-001Z	N	
01.94 → 08.96	ABF		246-080-010-002Z	N-H	T7: CL →
01.94 → 08.96	ABF		246-082-008-021G	SWP-M-C	T1: 6
01.94 → 08.96	ABF		246-083-002-014G	SWP-D-C	T1: 6
01.94 → 08.96	ABF		246-086-001-002C	HLWP	T1: 3
01.94 → 08.96	ABF		246-086-001-007C	HLWP	T1: 3b; T3: X11-246-003-014

2.8 VR6 (128 kW | 2.8 Liter)

06.91 → 08.96	AAA		246-069-056-001Z	N	
06.91 → 08.96	AAA		246-080-010-002Z	N-H	T7: CL →
06.91 → 08.91	AAA	→ M - 400 000	246-082-008-014C	SWP-M-C	T1: 1
08.91 → 08.96	AAA	N - 000 001 →	246-082-008-021G	SWP-M-C	T1: 6
10.93 → 08.96	AAA		246-083-002-014G	SWP-D-C	T1: 6
08.91 → 08.96	AAA	N - 000 001 →	246-086-001-002C	HLWP	T1: 3
06.91 → 08.91	AAA	→ M - 400 000	246-086-001-007C	HLWP	T1: 3b; T3: X11-246-003-014

1.6 TD (59 kW | 1.6 Liter)

08.88 → 09.93	RA / SB		246-069-056-001Z	N	
08.88 → 09.93	RA / SB		246-080-010-002Z	N-H	T7: CL →
08.88 → 07.91	RA / SB		246-082-008-014C	SWP-M-C	T1: 1
08.91 → 09.93	RA / SB		246-082-008-021G	SWP-M-C	T1: 6
08.91 → 09.93	RA / SB		246-086-001-002C	HLWP	T1: 3
08.88 → 07.91	RA / SB		246-086-001-007C	HLWP	T1: 3b; T3: X11-246-003-014



			VDO		
Datum	Motorcode	Fahrgestell Nr.	Artikel Nr.	Artikelbez.	Information

VW**PASSAT (3A2, 35I)****1.9 D (50 kW | 1.9 Liter)**

05.89 → 10.93	1Y		246-069-056-001Z	N	
05.89 → 10.93	1Y		246-080-010-002Z	N-H	T7: CL →
05.89 → 09.91	1Y	→ M - 400 000	246-082-008-014C	SWP-M-C	T1: 1
08.91 → 10.93	1Y	N - 000 001 →	246-082-008-021G	SWP-M-C	T1: 6
08.91 → 10.93	1Y	N - 000 001 →	246-086-001-002C	HLWP	T1: 3
05.89 → 08.91	1Y	→ M - 400 000	246-086-001-007C	HLWP	T1: 3b; T3: X11-246-003-014

1.9 TD (55 kW | 1.9 Liter)

03.91 → 08.96	AAZ		246-069-056-001Z	N	
03.91 → 08.96	AAZ		246-080-010-002Z	N-H	T7: CL →
03.91 → 08.91	AAZ	→ M - 400 000	246-082-008-014C	SWP-M-C	T1: 1
08.91 → 08.96	AAZ	N - 000 001 →	246-082-008-021G	SWP-M-C	T1: 6
10.93 → 08.96	AAZ		246-083-002-014G	SWP-D-C	T1: 6
08.91 → 08.96	AAZ	N - 000 001 →	246-086-001-002C	HLWP	T1: 3
03.91 → 08.91	AAZ	→ M - 400 000	246-086-001-007C	HLWP	T1: 3b; T3: X11-246-003-014

1.9 TDI (66 kW | 1.9 Liter)

10.93 → 08.96	1Z		246-069-056-001Z	N	
10.93 → 08.96	1Z		246-080-010-002Z	N-H	T7: CL →
10.93 → 07.96	1Z		246-082-008-021G	SWP-M-C	T1: 6
10.93 → 07.96	1Z		246-083-002-014G	SWP-D-C	T1: 6
10.93 → 07.96	1Z		246-086-001-002C	HLWP	T1: 3
10.93 → 08.96	1Z		246-086-001-007C	HLWP	T1: 3b; T3: X11-246-003-014

1.9 TDI (81 kW | 1.9 Liter)

03.96 → 08.96	AFN		246-069-056-001Z	N	
03.96 → 08.96	AFN		246-080-010-002Z	N-H	T7: CL →
03.96 → 08.96	AFN		246-082-008-021G	SWP-M-C	T1: 6
03.96 → 08.96	AFN		246-083-002-014G	SWP-D-C	T1: 6
03.96 → 08.96	AFN		246-086-001-002C	HLWP	T1: 3
03.96 → 08.96	AFN		246-086-001-007C	HLWP	T1: 3b; T3: X11-246-003-014

PASSAT Variant (3A5, 35I)**1.6 (53 kW | 1.6 Liter)**

04.88 → 09.91	1F / EZ		246-069-056-001Z	N	
06.88 → 09.91	1F / EZ		246-080-010-002Z	N-H	T7: CL →
08.88 → 07.90	1F / EZ		246-083-002-014G	SWP-D-C	T1: 6
08.88 → 07.90	1F / EZ		246-086-001-007C	HLWP	T1: 3b; T3: X11-246-003-014



			VDO		
Datum	Motorcode	Fahrgestell Nr.	Artikel Nr.	Artikelbez.	Information

VW**PASSAT Variant (3A5, 35I)****1.6 (55 kW | 1.6 Liter)**

04.88 → 12.88	EZ		246-069-056-001Z	N	
06.88 → 12.88	EZ		246-080-010-002Z	N-H	T7: CL →
04.88 → 12.88	EZ		246-083-002-014G	SWP-D-C	T1: 6
04.88 → 12.88	EZ	→ M - 400 000	246-086-001-007C	HLWP	T1: 3b; T3: X11-246-003-014

1.6 (74 kW | 1.6 Liter)

07.94 → 12.95	AEK / AFT		246-069-056-001Z	N	
07.94 → 12.95	AEK / AFT		246-080-010-002Z	N-H	T7: CL →
10.94 → 11.95	AEK / AFT		246-083-002-014G	SWP-D-C	T1: 6
10.94 → 11.95	AEK / AFT		246-086-001-002C	HLWP	T1: 3
07.94 → 12.95	AEK / AFT	- N - 000 001 →	246-086-001-007C	HLWP	T1: 3b; T3: X11-246-003-014

1.8 (55 kW | 1.8 Liter)

08.90 → 05.97	AAM		246-069-056-001Z	N	
08.90 → 05.97	AAM		246-080-010-002Z	N-H	T7: CL →
08.90 → 12.96	AAM		246-083-002-014G	SWP-D-C	T1: 6
08.91 → 12.96	AAM	N - 000 001 →	246-086-001-002C	HLWP	T1: 3
08.90 → 08.91	AAM	→ M - 400 000	246-086-001-007C	HLWP	T1: 3b; T3: X11-246-003-014

1.8 (66 kW | 1.8 Liter)

02.88 → 05.97	ABS / ADZ / RP		246-069-056-001Z	N	
06.88 → 05.97	ABS / ADZ / RP		246-080-010-002Z	N-H	T7: CL →
04.88 → 09.94	ABS / ADZ / RP		246-083-002-014G	SWP-D-C	T1: 6
08.91 → 09.94	ABS / ADZ / RP	N - 000 001 →	246-086-001-002C	HLWP	T1: 3
04.88 → 08.91	ABS / ADZ / RP	→ M - 400 000	246-086-001-007C	HLWP	T1: 3b; T3: X11-246-003-014

1.8 (79 kW | 1.8 Liter)

04.88 → 07.90	PF		246-069-056-001Z	N	
06.88 → 07.90	PF		246-080-010-002Z	N-H	T7: CL →
08.88 → 07.90	PF		246-083-002-014G	SWP-D-C	T1: 6
08.88 → 07.90	PF		246-086-001-007C	HLWP	T1: 3b; T3: X11-246-003-014

1.8 (82 kW | 1.8 Liter)

04.88 → 07.92	PB		246-069-056-001Z	N	
06.88 → 07.92	PB		246-080-010-002Z	N-H	T7: CL →

1.8 16V (100 kW | 1.8 Liter)

04.88 → 12.89	KR		246-069-056-001Z	N	
06.88 → 12.89	KR		246-080-010-002Z	N-H	T7: CL →
09.89 → 12.89	KR		246-083-002-006G	SWP-D-C	T1: 1
08.88 → 12.89	KR		246-083-002-014G	SWP-D-C	T1: 6
08.88 → 12.89	KR	→ M - 400 000	246-086-001-007C	HLWP	T1: 3b; T3: X11-246-003-014



			VDO		
Datum	Motorcode	Fahrgestell Nr.	Artikel Nr.	Artikelbez.	Information

VW**PASSAT Variant (3A5, 35I)****1.8 G60 Syncro (118 kW | 1.8 Liter)**

08.88 → 05.97	PG		246-069-056-001Z	N	
08.88 → 05.97	PG		246-080-010-002Z	N-H	T7: CL →
08.91 → 05.97	PG	- N - 000 001 →	246-086-001-007C	HLWP	T1: 3b; T3: X11-246-003-014

2.0 (79 kW | 2.0 Liter)

03.95 → 08.96	AEP		246-069-056-001Z	N	
03.95 → 08.96	AEP		246-080-010-002Z	N-H	T7: CL →
03.95 → 08.96	AEP		246-083-002-014G	SWP-D-C	T1: 6
03.95 → 08.96	AEP		246-086-001-002C	HLWP	T1: 3
03.95 → 08.96	AEP	- N - 000 001 →	246-086-001-007C	HLWP	T1: 3b; T3: X11-246-003-014

2.0 (85 kW | 2.0 Liter)

02.90 → 05.97	2E / ADY / AGG		246-069-056-001Z	N	
02.90 → 05.97	2E / ADY / AGG		246-080-010-002Z	N-H	T7: CL →
08.90 → 08.91	2E / ADY / AGG	→ M - 500 000	246-083-002-006G	SWP-D-C	T1: 1
03.90 → 07.95	2E / ADY / AGG	N - 000 001 →	246-083-002-014G	SWP-D-C	T1: 6
08.91 → 07.95	2E / ADY / AGG	N - 000 001 →	246-086-001-002C	HLWP	T1: 3
03.90 → 08.91	2E / ADY / AGG		246-086-001-007C	HLWP	T1: 3b; T3: X11-246-003-014

2.0 Syncro (85 kW | 2.0 Liter)

10.90 → 05.97	2E / ADY / AGG		246-069-056-001Z	N	
10.90 → 05.97	2E / ADY / AGG		246-080-010-002Z	N-H	T7: CL →
01.94 → 09.94	2E / ADY / AGG		246-083-002-014G	SWP-D-C	T1: 6
01.94 → 09.94	2E / ADY / AGG		246-086-001-002C	HLWP	T1: 3
08.91 → 05.97	2E / ADY / AGG	- N - 000 001 →	246-086-001-007C	HLWP	T1: 3b; T3: X11-246-003-014

2.0 16V (100 kW | 2.0 Liter)

08.88 → 09.93	9A		246-069-056-001Z	N	
08.88 → 09.93	9A		246-080-010-002Z	N-H	T7: CL →
08.88 → 09.91	9A		246-083-002-014G	SWP-D-C	T1: 6
08.91 → 09.91	9A	N - 000 001 →	246-086-001-002C	HLWP	T1: 3
08.88 → 08.91	9A	→ M - 400 000	246-086-001-007C	HLWP	T1: 3b; T3: X11-246-003-014





2.0 16V (110 kW | 2.0 Liter)

01.94 → 05.97	ABF		246-069-056-001Z	N	
01.94 → 05.97	ABF		246-080-010-002Z	N-H	T7: CL →
01.94 → 12.96	ABF		246-083-002-014G	SWP-D-C	T1: 6
01.94 → 12.96	ABF		246-086-001-002C	HLWP	T1: 3
01.94 → 05.97	ABF	- N - 000 001 →	246-086-001-007C	HLWP	T1: 3b; T3: X11-246-003-014

2.8 VR6 (128 kW | 2.8 Liter)

06.91 → 05.97	AAA		246-069-056-001Z	N	
06.91 → 05.97	AAA		246-080-010-002Z	N-H	T7: CL →
06.91 → 12.96	AAA		246-083-002-014G	SWP-D-C	T1: 6



			VDO		
Datum	Motorcode	Fahrgestell Nr.	Artikel Nr.	Artikelbez.	Information

VW**PASSAT Variant (3A5, 35I)****2.8 VR6 (128 kW | 2.8 Liter)**

08.91 → 12.96	AAA	N - 000 001 →	246-086-001-002C	HLWP	T1: 3
06.91 → 05.97	AAA	→ M - 400 000	246-086-001-007C	HLWP	T1: 3b; T3: X11-246-003-014

2.9 VR6 Syncro (135 kW | 2.9 Liter)

01.94 → 05.97	ABV		246-069-056-001Z	N	
01.94 → 05.97	ABV		246-080-010-002Z	N-H	T7: CL →
01.94 → 05.97	ABV		246-083-002-014G	SWP-D-C	T1: 6
01.94 → 05.97	ABV		246-086-001-002C	HLWP	T1: 3
01.94 → 05.97	ABV	- N - 000 001 →	246-086-001-007C	HLWP	T1: 3b; T3: X11-246-003-014

1.6 TD (59 kW | 1.6 Liter)

08.88 → 09.93	RA / SB		246-069-056-001Z	N	
08.88 → 09.93	RA / SB		246-080-010-002Z	N-H	T7: CL →
08.88 → 09.93	RA / SB		246-083-002-014G	SWP-D-C	T1: 6
08.88 → 08.91	RA / SB		246-086-001-007C	HLWP	T1: 3b; T3: X11-246-003-014

1.9 D (50 kW | 1.9 Liter)

05.89 → 10.93	1Y		246-069-056-001Z	N	
05.89 → 10.93	1Y		246-080-010-002Z	N-H	T7: CL →
05.89 → 07.90	1Y		246-083-002-014G	SWP-D-C	T1: 6
05.89 → 07.90	1Y		246-086-001-007C	HLWP	T1: 3b; T3: X11-246-003-014

1.9 TD (55 kW | 1.9 Liter)

03.91 → 05.97	AAZ		246-069-056-001Z	N	
03.91 → 05.97	AAZ		246-080-010-002Z	N-H	T7: CL →
03.91 → 12.96	AAZ		246-083-002-014G	SWP-D-C	T1: 6
08.91 → 12.96	AAZ	N - 000 001 →	246-086-001-002C	HLWP	T1: 3
03.91 → 08.91	AAZ	→ M - 400 000	246-086-001-007C	HLWP	T1: 3b; T3: X11-246-003-014

1.9 TDI (66 kW | 1.9 Liter)

10.93 → 05.97	1Z / AHU		246-069-056-001Z	N	
10.93 → 05.97	1Z / AHU		246-080-010-002Z	N-H	T7: CL →
10.93 → 12.96	1Z / AHU		246-083-002-014G	SWP-D-C	T1: 6
10.93 → 12.96	1Z / AHU		246-086-001-002C	HLWP	T1: 3
10.93 → 05.97	1Z / AHU	- N - 000 001 →	246-086-001-007C	HLWP	T1: 3b; T3: X11-246-003-014

1.9 TDI (81 kW | 1.9 Liter)

03.96 → 05.97	AFN		246-069-056-001Z	N	
03.96 → 05.97	AFN		246-080-010-002Z	N-H	T7: CL →
03.96 → 12.96	AFN		246-083-002-014G	SWP-D-C	T1: 6
03.96 → 12.96	AFN		246-086-001-002C	HLWP	T1: 3
03.96 → 05.97	AFN	- N - 000 001 →	246-086-001-007C	HLWP	T1: 3b; T3: X11-246-003-014



			VDO		
Datum	Motorcode	Fahrgestell Nr.	Artikel Nr.	Artikelbez.	Information

VW**PASSAT (3B2)****1.6 (74 kW | 1.6 Liter)**

10.96 → 12.96	ADP / AHL / ANA / ARM		246-082-008-021G	SWP-M-C	T1: 6
10.96 → 10.97	ADP / AHL / ANA / ARM		246-082-008-025G	SWP-M-C	T1: 3
10.96 → 12.96	ADP / AHL / ANA / ARM		246-083-002-014G	SWP-D-C	T1: 6
10.96 → 10.97	ADP / AHL / ANA / ARM		246-083-002-022G	SWP-D-C	T1: 3
10.96 → 10.97	ADP / AHL / ANA / ARM		246-086-001-002C	HLWP	T1: 3
10.96 → 11.00	ADP / AHL / ANA / ARM		246-086-001-007C	HLWP	T1: 3b; T3: X11-246-003-014

1.8 (85 kW | 1.8 Liter)

01.97 → 11.00	AFY		246-086-001-007C	HLWP	T1: 3b; T3: X11-246-003-014
---------------	-----	--	------------------	------	--------------------------------

1.8 (92 kW | 1.8 Liter)

10.96 → 01.99	ADR / APT / ARG		246-082-008-025G	SWP-M-C	T1: 3
10.96 → 01.99	ADR / APT / ARG		246-083-002-022G	SWP-D-C	T1: 3
10.96 → 01.99	ADR / APT / ARG		246-086-001-002C	HLWP	T1: 3
10.96 → 11.00	ADR / APT / ARG		246-086-001-007C	HLWP	T1: 3b; T3: X11-246-003-014

1.8 Syncro/4motion (92 kW | 1.8 Liter)

10.96 → 11.00	ADR / APT / ARG		246-086-001-007C	HLWP	T1: 3b; T3: X11-246-003-014
---------------	-----------------	--	------------------	------	--------------------------------

1.8 T (110 kW | 1.8 Liter)

10.96 → 12.98	AEB / ANB / APU		246-082-008-025G	SWP-M-C	T1: 3
10.96 → 12.98	AEB / ANB / APU		246-083-002-022G	SWP-D-C	T1: 3
10.96 → 12.98	AEB / ANB / APU		246-086-001-002C	HLWP	T1: 3
10.96 → 11.00	AEB / ANB / APU		246-086-001-007C	HLWP	T1: 3b; T3: X11-246-003-014

2.0 (88 kW | 2.0 Liter)

04.00 → 11.00	ASU / AUZ		246-086-001-007C	HLWP	T1: 3b; T3: X11-246-003-014
---------------	-----------	--	------------------	------	--------------------------------

2.0 4motion (88 kW | 2.0 Liter)

04.00 → 11.00			246-086-001-007C	HLWP	T1: 3b; T3: X11-246-003-014
---------------	--	--	------------------	------	--------------------------------





2.3 VR5 (110 kW | 2.3 Liter)

10.96 → 04.98	AGZ		246-082-008-025G	SWP-M-C	T1: 3
10.96 → 04.98	AGZ		246-083-002-022G	SWP-D-C	T1: 3
10.96 → 04.98	AGZ		246-086-001-002C	HLWP	T1: 3
10.96 → 11.00	AGZ		246-086-001-007C	HLWP	T1: 3b; T3: X11-246-003-014

2.3 VR5 Syncro/4motion (110 kW | 2.3 Liter)

10.97 → 04.99	AGZ		246-082-008-025G	SWP-M-C	T1: 3
10.97 → 04.99	AGZ		246-083-002-022G	SWP-D-C	T1: 3
10.97 → 04.99	AGZ		246-086-001-002C	HLWP	T1: 3
10.97 → 11.00	AGZ		246-086-001-007C	HLWP	T1: 3b; T3: X11-246-003-014



			VDO		
Datum	Motorcode	Fahrgestell Nr.	Artikel Nr.	Artikelbez.	Information

VW**PASSAT (3B2)****2.8 V6 (132 kW | 2.8 Liter)**

05.97 → 09.99	AGE		246-086-001-007C	HLWP	T1: 3b; T3: X11-246-003-014
---------------	-----	--	------------------	------	--------------------------------

2.8 V6 (140 kW | 2.8 Liter)

09.99 → 11.00	ATX		246-086-001-007C	HLWP	T1: 3b; T3: X11-246-003-014
---------------	-----	--	------------------	------	--------------------------------

2.8 V6 4motion (140 kW | 2.8 Liter)

09.99 → 11.00	ATX		246-086-001-007C	HLWP	T1: 3b; T3: X11-246-003-014
---------------	-----	--	------------------	------	--------------------------------

2.8 V6 (142 kW | 2.8 Liter)

06.97 → 04.99	ACK / APR / AQD		246-082-008-025G	SWP-M-C	T1: 3
06.97 → 04.99	ACK / APR / AQD		246-083-002-022G	SWP-D-C	T1: 3
06.97 → 04.99	ACK / APR / AQD		246-086-001-002C	HLWP	T1: 3
08.96 → 11.00	ACK / APR / AQD		246-086-001-007C	HLWP	T1: 3b; T3: X11-246-003-014

2.8 V6 Syncro/4motion (142 kW | 2.8 Liter)

01.97 → 09.99	ACK / ALG / APR / AQD		246-082-008-025G	SWP-M-C	T1: 3
01.97 → 09.99	ACK / ALG / APR / AQD		246-083-002-022G	SWP-D-C	T1: 3
01.97 → 09.99	ACK / ALG / APR / AQD		246-086-001-002C	HLWP	T1: 3
10.96 → 11.00	ACK / ALG / APR / AQD		246-086-001-007C	HLWP	T1: 3b; T3: X11-246-003-014

1.9 TDI (66 kW | 1.9 Liter)

10.96 → 12.96	AHH / AHU		246-082-008-021G	SWP-M-C	T1: 6
10.96 → 12.96	AHH / AHU		246-083-002-014G	SWP-D-C	T1: 6
10.96 → 12.96	AHH / AHU		246-086-001-002C	HLWP	T1: 3
10.96 → 11.00	AHH / AHU		246-086-001-007C	HLWP	T1: 3b; T3: X11-246-003-014

1.9 TDI (74 kW | 1.9 Liter)

02.00 → 11.00	AVB		246-086-001-007C	HLWP	T1: 3b; T3: X11-246-003-014
---------------	-----	--	------------------	------	--------------------------------

1.9 TDI (81 kW | 1.9 Liter)

10.96 → 11.00	AFN / AVG		246-086-001-007C	HLWP	T1: 3b; T3: X11-246-003-014
---------------	-----------	--	------------------	------	--------------------------------

1.9 TDI Syncro/4motion (81 kW | 1.9 Liter)

10.96 → 11.00	AFN / AVG		246-086-001-007C	HLWP	T1: 3b; T3: X11-246-003-014
---------------	-----------	--	------------------	------	--------------------------------

1.9 TDI (85 kW | 1.9 Liter)

08.98 → 04.99	AJM / ATJ		246-082-008-025G	SWP-M-C	T1: 3
08.98 → 04.99	AJM / ATJ		246-083-002-022G	SWP-D-C	T1: 3
08.98 → 04.99	AJM / ATJ		246-086-001-002C	HLWP	T1: 3
08.98 → 11.00	AJM / ATJ		246-086-001-007C	HLWP	T1: 3b; T3: X11-246-003-014



			VDO		
Datum	Motorcode	Fahrgestell Nr.	Artikel Nr.	Artikelbez.	Information

VW**PASSAT (3B2)****1.9 TDI 4motion (85 kW | 1.9 Liter)**

09.99 → 11.00	AJM / ATJ		246-082-008-025G	SWP-M-C	T1: 3
09.99 → 11.00	AJM / ATJ		246-083-002-022G	SWP-D-C	T1: 3
09.99 → 11.00	AJM / ATJ		246-086-001-002C	HLWP	T1: 3
08.99 → 11.00	AJM / ATJ		246-086-001-007C	HLWP	T1: 3b; T3: X11-246-003-014

2.5 TDI (110 kW | 2.5 Liter)

08.98 → 11.00	AFB / AKN		246-082-008-025G	SWP-M-C	T1: 3
08.98 → 11.00	AFB / AKN		246-083-002-022G	SWP-D-C	T1: 3
08.98 → 11.00	AFB / AKN		246-086-001-002C	HLWP	T1: 3
07.98 → 11.00	AFB / AKN		246-086-001-007C	HLWP	T1: 3b; T3: X11-246-003-014

2.5 TDI Syncro/4motion (110 kW | 2.5 Liter)

02.99 → 04.99	AFB / AKN		246-082-008-025G	SWP-M-C	T1: 3
02.99 → 04.99	AFB / AKN		246-083-002-022G	SWP-D-C	T1: 3
02.99 → 04.99	AFB / AKN		246-086-001-002C	HLWP	T1: 3
12.98 → 11.00	AFB / AKN		246-086-001-007C	HLWP	T1: 3b; T3: X11-246-003-014

PASSAT Variant (3B5)**1.6 (74 kW | 1.6 Liter)**

06.97 → 05.99	ADP / AHL / ANA / ARM		246-083-002-022G	SWP-D-C	T1: 3
06.97 → 05.99	ADP / AHL / ANA / ARM		246-086-001-002C	HLWP	T1: 3

1.8 (85 kW | 1.8 Liter)

06.97 → 11.00	AFY		246-083-002-022G	SWP-D-C	T1: 3
---------------	-----	--	------------------	---------	-------

1.8 (92 kW | 1.8 Liter)

06.97 → 12.98	ADR / APT / ARG		246-083-002-022G	SWP-D-C	T1: 3
06.97 → 12.98	ADR / APT / ARG		246-086-001-002C	HLWP	T1: 3

1.8 Syncro/4motion (92 kW | 1.8 Liter)

08.97 → 01.99	ADR / APT / ARG		246-083-002-022G	SWP-D-C	T1: 3
08.97 → 01.99	ADR / APT / ARG		246-086-001-002C	HLWP	T1: 3

1.8 T (110 kW | 1.8 Liter)

06.97 → 12.98	AEB / ANB / APU		246-083-002-022G	SWP-D-C	T1: 3
06.97 → 12.98	AEB / ANB / APU		246-086-001-002C	HLWP	T1: 3

2.0 (88 kW | 2.0 Liter)

04.00 → 11.00	ASU / AUZ		246-083-002-022G	SWP-D-C	T1: 3
---------------	-----------	--	------------------	---------	-------

2.0 4motion (88 kW | 2.0 Liter)

04.00 → 11.00	ASU / AUZ		246-083-002-022G	SWP-D-C	T1: 3
---------------	-----------	--	------------------	---------	-------

2.3 VR5 (110 kW | 2.3 Liter)

06.97 → 04.98	AGZ		246-083-002-022G	SWP-D-C	T1: 3
06.97 → 04.98	AGZ		246-086-001-002C	HLWP	T1: 3

2.3 VR5 Syncro/4motion (110 kW | 2.3 Liter)

10.97 → 04.99	AGZ		246-083-002-022G	SWP-D-C	T1: 3
10.97 → 04.99	AGZ		246-086-001-002C	HLWP	T1: 3



			VDO		
Datum	Motorcode	Fahrgestell Nr.	Artikel Nr.	Artikelbez.	Information

VW**PASSAT Variant (3B5)**

2.8 V6 (132 kW 2.8 Liter)					
09.97 → 09.99	AGE		246-083-002-022G	SWP-D-C	T1: 3
2.8 V6 (140 kW 2.8 Liter)					
09.99 → 11.00	ATX		246-083-002-022G	SWP-D-C	T1: 3
2.8 V6 4motion (140 kW 2.8 Liter)					
09.99 → 11.00	ATX		246-083-002-022G	SWP-D-C	T1: 3
2.8 V6 (142 kW 2.8 Liter)					
08.97 → 12.98	ACK / APR / AQD		246-083-002-022G	SWP-D-C	T1: 3
08.97 → 12.98	ACK / APR / AQD		246-086-001-002C	HLWP	T1: 3
2.8 V6 Syncro/4motion (142 kW 2.8 Liter)					
06.97 → 09.99	ACK / ALG / APR / AQD		246-083-002-022G	SWP-D-C	T1: 3
06.97 → 09.99	ACK / ALG / APR / AQD		246-086-001-002C	HLWP	T1: 3
1.9 TDI (66 kW 1.9 Liter)					
06.97 → 08.98	AHH / AHU		246-083-002-022G	SWP-D-C	T1: 3
06.97 → 08.98	AHH / AHU		246-086-001-002C	HLWP	T1: 3
1.9 TDI (74 kW 1.9 Liter)					
02.00 → 11.00	AVB		246-083-002-022G	SWP-D-C	T1: 3
1.9 TDI (81 kW 1.9 Liter)					
06.97 → 04.99	AFN / AVG		246-083-002-022G	SWP-D-C	T1: 3
06.97 → 04.99	AFN / AVG		246-086-001-002C	HLWP	T1: 3
1.9 TDI Syncro/4motion (81 kW 1.9 Liter)					
06.97 → 11.00	AFN / AVG		246-083-002-022G	SWP-D-C	T1: 3
1.9 TDI (85 kW 1.9 Liter)					
08.98 → 11.00	AJM / ATJ		246-083-002-022G	SWP-D-C	T1: 3
08.98 → 11.00	AJM / ATJ		246-086-001-002C	HLWP	T1: 3
1.9 TDI 4motion (85 kW 1.9 Liter)					
09.99 → 11.00	ATJ		246-083-002-022G	SWP-D-C	T1: 3
09.99 → 11.00	ATJ		246-086-001-002C	HLWP	T1: 3
2.5 TDI (110 kW 2.5 Liter)					
08.98 → 11.00	AFB / AKN		246-083-002-022G	SWP-D-C	T1: 3
08.98 → 11.00	AFB / AKN		246-086-001-002C	HLWP	T1: 3
2.5 TDI Syncro/4motion (110 kW 2.5 Liter)					
05.99 → 11.00	AFB / AKN		246-083-002-022G	SWP-D-C	T1: 3
05.99 → 11.00	AFB / AKN		246-086-001-002C	HLWP	T1: 3

PASSAT (3B3)

1.6 (75 kW 1.6 Liter)					
02.03 →	ALZ	-3-450 001 →; -3E420 001 →	246-082-008-025G	SWP-M-C	T1: 3
11.00 →	ALZ		246-086-001-007C	HLWP	T1: 3b; T3: X11-246-003-014



			VDO		
Datum	Motorcode	Fahrgestell Nr.	Artikel Nr.	Artikelbez.	Information

VW**PASSAT (3B3)****1.8 T 20V (110 kW | 1.8 Liter)**

11.00 →	AWT		246-082-008-025G	SWP-M-C	T1: 3
11.00 →	AWT		246-083-002-022G	SWP-D-C	T1: 3
11.00 →	AWT		246-086-001-007C	HLWP	T1: 3b; T3: X11-246-003-014

1.8 T (125 kW | 1.8 Liter)

02.03 →	AWM	-3-450 001 →; -3E420 001 →	246-082-008-025G	SWP-M-C	T1: 3
02.01 →	AWM		246-086-001-007C	HLWP	T1: 3b; T3: X11-246-003-014

2.0 (85 kW | 2.0 Liter)

02.03 →	AZM	-3-450 001 →; -3E420 001 →	246-082-008-025G	SWP-M-C	T1: 3
11.00 →	AZM		246-086-001-007C	HLWP	T1: 3b; T3: X11-246-003-014

2.0 4motion (85 kW | 2.0 Liter)

02.03 →	AZM	-3-450 001 →; -3E420 001 →	246-082-008-025G	SWP-M-C	T1: 3
11.00 →	AZM		246-086-001-007C	HLWP	T1: 3b; T3: X11-246-003-014

2.0 (96 kW | 2.0 Liter)

02.03 →	ALT	-3-450 001 →; -3E420 001 →	246-082-008-025G	SWP-M-C	T1: 3
11.01 →	ALT		246-086-001-007C	HLWP	T1: 3b; T3: X11-246-003-014

2.3 V5 (125 kW | 2.3 Liter)

02.03 →	AZX	-3-450 001 →; -3E420 001 →	246-082-008-025G	SWP-M-C	T1: 3
11.00 →	AZX		246-086-001-007C	HLWP	T1: 3b; T3: X11-246-003-014

2.3 V5 4motion (125 kW | 2.3 Liter)

02.03 →	AZX	-3-450 001 →; -3E420 001 →	246-082-008-025G	SWP-M-C	T1: 3
11.00 →	AZX		246-086-001-007C	HLWP	T1: 3b; T3: X11-246-003-014

2.8 4motion (142 kW | 2.8 Liter)

11.00 →	AMX / ATQ		246-082-008-025G	SWP-M-C	T1: 3
11.00 →	AMX / ATQ		246-083-002-022G	SWP-D-C	T1: 3
11.00 →	AMX / ATQ		246-086-001-007C	HLWP	T1: 3b; T3: X11-246-003-014

4.0 W8 4motion (202 kW | 4.0 Liter)

02.03 →	BDN / BDP	-3-450 001 →; -3E420 001 →	246-082-008-025G	SWP-M-C	T1: 3
09.01 →	BDN / BDP		246-086-001-007C	HLWP	T1: 3b; T3: X11-246-003-014



			VDO		
Datum	Motorcode	Fahrgestell Nr.	Artikel Nr.	Artikelbez.	Information

VW**PASSAT (3B3)****1.9 TDI (74 kW | 1.9 Liter)**

02.03 →	AVB	-3-450 001 →; -3E420 001 →	246-082-008-025G	SWP-M-C	T1: 3
11.00 →	AVB		246-086-001-007C	HLWP	T1: 3b; T3: X11-246-003-014

1.9 TDI (96 kW | 1.9 Liter)

02.03 →	AVF / AWX	-3-450 001 →; -3E420 001 →	246-082-008-025G	SWP-M-C	T1: 3
11.00 →	AVF / AWX		246-086-001-007C	HLWP	T1: 3b; T3: X11-246-003-014

1.9 TDI 4motion (96 kW | 1.9 Liter)

02.03 →	AVF	-3-450 001 →; -3E420 001 →	246-082-008-025G	SWP-M-C	T1: 3
11.00 →	AVF		246-086-001-007C	HLWP	T1: 3b; T3: X11-246-003-014

2.0 TDI (100 kW | 2.0 Liter)

12.03 →	BGW		246-082-008-025G	SWP-M-C	T1: 3
12.03 →	BGW		246-083-002-022G	SWP-D-C	T1: 3

2.5 TDI (110 kW | 2.5 Liter)

02.03 →	AFB / AKN	-3-450 001 →; -3E420 001 →	246-082-008-025G	SWP-M-C	T1: 3
11.00 →	AFB / AKN		246-086-001-007C	HLWP	T1: 3b; T3: X11-246-003-014

2.5 TDI 4motion (110 kW | 2.5 Liter)

02.03 →	AFB / AKN	-3-450 001 →; -3E420 001 →	246-082-008-025G	SWP-M-C	T1: 3
11.00 →	AFB / AKN		246-086-001-007C	HLWP	T1: 3b; T3: X11-246-003-014

2.5 TDI (120 kW | 2.5 Liter)

05.03 →	BDG	-3-450 001 →; -3E420 001 →	246-082-008-025G	SWP-M-C	T1: 3
---------	-----	-------------------------------	------------------	---------	-------

2.5 TDI 4motion (132 kW | 2.5 Liter)

02.03 →	BAU / BDH	-3-450 001 →; -3E420 001 →	246-082-008-025G	SWP-M-C	T1: 3
---------	-----------	-------------------------------	------------------	---------	-------

PASSAT Variant (3B6)**1.6 (75 kW | 1.6 Liter)**

11.00 →	ALZ		246-083-002-022G	SWP-D-C	T1: 3
---------	-----	--	------------------	---------	-------

1.8 T 20V (110 kW | 1.8 Liter)

11.00 →	AWT		246-083-002-022G	SWP-D-C	T1: 3
---------	-----	--	------------------	---------	-------

2.0 (85 kW | 2.0 Liter)

11.00 →	AZM		246-083-002-022G	SWP-D-C	T1: 3
---------	-----	--	------------------	---------	-------

2.0 4motion (85 kW | 2.0 Liter)

11.00 →	AZM		246-083-002-022G	SWP-D-C	T1: 3
---------	-----	--	------------------	---------	-------



			VDO		
Datum	Motorcode	Fahrgestell Nr.	Artikel Nr.	Artikelbez.	Information

VW**PASSAT Variant (3B6)****2.0 (96 kW | 2.0 Liter)**

11.01 → ALT 246-083-002-022G SWP-D-C T1: 3

2.3 VR5 (125 kW | 2.3 Liter)

11.00 → AZX 246-083-002-022G SWP-D-C T1: 3

2.3 VR5 4motion (125 kW | 2.3 Liter)

11.00 → AZX 246-083-002-022G SWP-D-C T1: 3

2.8 4motion (142 kW | 2.8 Liter)

11.00 → AMX / ATQ 246-083-002-022G SWP-D-C T1: 3

4.0 W8 4motion (202 kW | 4.0 Liter)

09.01 → BDN / BDP 246-083-002-022G SWP-D-C T1: 3

1.9 TDI (74 kW | 1.9 Liter)

11.00 → AVB 246-083-002-022G SWP-D-C T1: 3

1.9 TDI (96 kW | 1.9 Liter)

11.00 → AVF / AWX 246-083-002-022G SWP-D-C T1: 3

1.9 TDI 4motion (96 kW | 1.9 Liter)

11.00 → AVF 246-083-002-022G SWP-D-C T1: 3

2.0 TDI (100 kW | 2.0 Liter)

12.03 → BGW 246-083-002-022G SWP-D-C T1: 3

2.5 TDI (110 kW | 2.5 Liter)

11.00 → AFB / AKN 246-083-002-022G SWP-D-C T1: 3

2.5 TDI 4motion (110 kW | 2.5 Liter)

11.00 → AFB / AKN 246-083-002-022G SWP-D-C T1: 3

2.5 TDI (120 kW | 2.5 Liter)

05.03 → BDG 246-083-002-022G SWP-D-C T1: 3

2.5 TDI 4motion (132 kW | 2.5 Liter)

01.03 → BAU / BDH 246-083-002-022G SWP-D-C T1: 3

PASSAT (3C2)**1.6 FSI (85 kW | 1.6 Liter)**

03.05 → BLF 246-082-008-025G SWP-M-C T1: 3

03.05 → BLF 246-083-002-022G SWP-D-C T1: 3

03.05 → BLF 246-086-001-007C HLWP T1: 3b

2.0 FSI (110 kW | 2.0 Liter)

03.05 → BLR / BLY 246-082-008-025G SWP-M-C T1: 3

03.05 → BLR / BLY 246-083-002-022G SWP-D-C T1: 3

03.05 → BLR / BLY 246-086-001-007C HLWP T1: 3b

3.2 FSI (184 kW | 3.2 Liter)

11.05 → AXZ 246-082-008-025G SWP-M-C T1: 3

11.05 → AXZ 246-083-002-022G SWP-D-C T1: 3

11.05 → AXZ 246-086-001-007C HLWP T1: 3b

1.9 TDI (77 kW | 1.9 Liter)

03.05 → BKC 246-082-008-025G SWP-M-C T1: 3

03.05 → BKC 246-083-002-022G SWP-D-C T1: 3

03.05 → BKC 246-086-001-007C HLWP T1: 3b



			VDO		
Datum	Motorcode	Fahrgestell Nr.	Artikel Nr.	Artikelbez.	Information

VW**PASSAT (3C2)****2.0 TDI (103 kW | 2.0 Liter)**

03.05 →	BKP / BMP		246-082-008-025G	SWP-M-C	T1: 3
03.05 →	BKP / BMP		246-083-002-022G	SWP-D-C	T1: 3
03.05 →	BKP / BMP		246-086-001-007C	HLWP	T1: 3b

2.0 TDI (125 kW | 2.0 Liter)

08.05 →	BMR		246-082-008-025G	SWP-M-C	T1: 3
08.05 →	BMR		246-083-002-022G	SWP-D-C	T1: 3
08.05 →	BMR		246-086-001-007C	HLWP	T1: 3b

PASSAT Variant (3C5)**1.6 (75 kW | 1.6 Liter)**

08.05 →	BSE / BSF		246-086-001-007C	HLWP	T1: 3b
---------	-----------	--	------------------	------	--------

1.6 FSI (85 kW | 1.6 Liter)

08.05 →	BLF		246-086-001-007C	HLWP	T1: 3b
---------	-----	--	------------------	------	--------

2.0 FSI (110 kW | 2.0 Liter)

08.05 →	BLR / BLY		246-086-001-007C	HLWP	T1: 3b
---------	-----------	--	------------------	------	--------

1.9 TDI (77 kW | 1.9 Liter)

08.05 →	BKC / BLS		246-086-001-007C	HLWP	T1: 3b
---------	-----------	--	------------------	------	--------

2.0 TDI (90 kW | 2.0 Liter)

08.05 →	BVD / BVE		246-086-001-007C	HLWP	T1: 3b
---------	-----------	--	------------------	------	--------

2.0 TDI (100 kW | 2.0 Liter)

08.05 →	BMA		246-086-001-007C	HLWP	T1: 3b
---------	-----	--	------------------	------	--------

2.0 TDI (103 kW | 2.0 Liter)

08.05 →	BKP / BMP		246-086-001-007C	HLWP	T1: 3b
---------	-----------	--	------------------	------	--------

PHAETON (3D2)**3.2 V6 (177 kW | 3.2 Liter)**

04.02 →	AYT / BKL		246-082-008-025G	SWP-M-C	T1: 3
---------	-----------	--	------------------	---------	-------

3.2 V6 4motion (177 kW | 3.2 Liter)

02.04 →	BKL / BRK		246-082-008-025G	SWP-M-C	T1: 3
---------	-----------	--	------------------	---------	-------

4.2 V8 4motion (246 kW | 4.2 Liter)

05.03 →	BGH / BGJ		246-082-008-025G	SWP-M-C	T1: 3
---------	-----------	--	------------------	---------	-------

6.0 W12 4motion (309 kW | 6.0 Liter)

04.02 →	BAN		246-082-008-025G	SWP-M-C	T1: 3
---------	-----	--	------------------	---------	-------

3.0 V6 TDI 4motion (165 kW | 3.0 Liter)

09.04 →	BMK		246-082-008-025G	SWP-M-C	T1: 3
---------	-----	--	------------------	---------	-------

5.0 V10 TDI 4motion (230 kW | 5.0 Liter)

11.02 →	AJS		246-082-008-025G	SWP-M-C	T1: 3
---------	-----	--	------------------	---------	-------



			VDO		
Datum	Motorcode	Fahrgestell Nr.	Artikel Nr.	Artikelbez.	Information

VW**POLO (86)****0.9 (29 kW | 0.9 Liter)**

09.75 → 12.78	HA	→ 869 2556 859	246-075-021-006C	SWP-M-G	T1: 1; T2: B
12.78 → 09.81	HA	869 2556 560 →	246-082-008-014C	SWP-M-C	T1: 1
09.75 → 09.81	HA	869 2556 860 →	246-086-001-007C	HLWP	T1: 3b; T3: X11-246-003-014

1.1 (37 kW | 1.1 Liter)

03.75 → 12.78	HB	→ 869 2556 859	246-075-021-006C	SWP-M-G	T1: 1; T2: B
12.78 → 07.81	HB	869 2556 560 →	246-082-008-014C	SWP-M-C	T1: 1
03.75 → 09.81	HB	869 2556 860 →	246-086-001-007C	HLWP	T1: 3b; T3: X11-246-003-014

1.1 (44 kW | 1.1 Liter)

03.75 → 07.77	HC		246-075-021-006C	SWP-M-G	T1: 1; T2: B
03.75 → 09.81	HC	869 2556 860 →	246-086-001-007C	HLWP	T1: 3b; T3: X11-246-003-014

1.3 (44 kW | 1.3 Liter)

08.77 → 12.78	HH	→ 869 2556 859	246-075-021-006C	SWP-M-G	T1: 1; T2: B
12.78 → 09.81	HH	869 2556 560 →	246-082-008-014C	SWP-M-C	T1: 1
12.76 → 09.81	HH	869 2556 860 →	246-086-001-007C	HLWP	T1: 3b; T3: X11-246-003-014

POLO (86C, 80)**0.9 (29 kW | 0.9 Liter)**

10.81 → 12.81	HA		246-086-001-007C	HLWP	T1: 3b; T3: X11-246-003-014
---------------	----	--	------------------	------	--------------------------------

1.0 (29 kW | 1.0 Liter)

08.83 → 10.86	GL		246-082-008-014C	SWP-M-C	T1: 1
10.81 → 10.86	GL		246-086-001-007C	HLWP	T1: 3b; T3: X11-246-003-014

1.0 (33 kW | 1.0 Liter)

08.85 → 01.92	HZ		246-086-001-007C	HLWP	T1: 3b; T3: X11-246-003-014
---------------	----	--	------------------	------	--------------------------------





1.0 KAT (33 kW | 1.0 Liter)

10.90 → 09.94	AAK / AAU / ACM		246-082-008-014C	SWP-M-C	T1: 1
10.90 → 09.94	AAK / AAU / ACM		246-083-002-014G	SWP-D-C	T1: 6
10.90 → 09.94	AAK / AAU / ACM		246-086-001-002C	HLWP	T1: 3
08.89 → 09.94	AAK / AAU / ACM		246-086-001-007C	HLWP	T1: 3b; T3: X11-246-003-014

1.1 (37 kW | 1.1 Liter)

10.81 → 07.83	HB		246-082-008-014C	SWP-M-C	T1: 1
10.81 → 09.89	HB		246-086-001-007C	HLWP	T1: 3b; T3: X11-246-003-014



			VDO		
Datum	Motorcode	Fahrgestell Nr.	Artikel Nr.	Artikelbez.	Information

VW**POLO (86C, 80)****1.3 (40 kW | 1.3 Liter)**

08.85 → 07.88	HK / MH		246-082-008-014C	SWP-M-C	T1: 1
08.86 → 07.88	HK / MH		246-083-002-006G	SWP-D-C	T1: 1
08.83 → 07.88	HK / MH		246-086-001-007C	HLWP	T1: 3b; T3: X11-246-003-014

1.3 KAT (40 kW | 1.3 Liter)

08.88 → 10.90	2G / AAV / MH / NZ		246-082-008-014C	SWP-M-C	T1: 1
08.88 → 10.90	2G / AAV / MH / NZ		246-083-002-006G	SWP-D-C	T1: 1
07.87 → 09.94	2G / AAV / MH / NZ		246-086-001-007C	HLWP	T1: 3b; T3: X11-246-003-014

1.3 (43 kW | 1.3 Liter)

10.81 → 07.82	HJ		246-082-008-014C	SWP-M-C	T1: 1
10.81 → 07.82	HJ		246-086-001-007C	HLWP	T1: 3b

1.3 (44 kW | 1.3 Liter)

10.81 → 07.83	HH		246-082-008-014C	SWP-M-C	T1: 1
10.81 → 07.83	HH		246-086-001-007C	HLWP	T1: 3b; T3: X11-246-003-014

1.3 (55 kW | 1.3 Liter)

08.86 → 09.89	GK		246-082-008-014C	SWP-M-C	T1: 1
08.86 → 09.89	GK		246-083-002-006G	SWP-D-C	T1: 1
09.82 → 09.89	GK		246-086-001-007C	HLWP	T1: 3b; T3: X11-246-003-014

1.3 KAT (55 kW | 1.3 Liter)

10.89 → 03.91	3F		246-082-008-014C	SWP-M-C	T1: 1
10.89 → 10.90	3F		246-083-002-006G	SWP-D-C	T1: 1
10.90 → 03.91	3F		246-083-002-014G	SWP-D-C	T1: 6
10.90 → 03.91	3F		246-086-001-002C	HLWP	T1: 3
10.89 → 03.91	3F		246-086-001-007C	HLWP	T1: 3b; T3: X11-246-003-014

1.3 D (33 kW | 1.3 Liter)

08.86 → 07.90	MN		246-082-008-014C	SWP-M-C	T1: 1
08.86 → 07.90	MN		246-083-002-006G	SWP-D-C	T1: 1
08.86 → 07.90	MN		246-086-001-007C	HLWP	T1: 3b; T3: X11-246-003-014

1.4 D (35 kW | 1.4 Liter)

10.90 → 07.91	1W		246-082-008-014C	SWP-M-C	T1: 1
10.90 → 07.91	1W		246-083-002-014G	SWP-D-C	T1: 6
10.90 → 07.91	1W		246-086-001-002C	HLWP	T1: 3
10.90 → 09.94	1W		246-086-001-007C	HLWP	T1: 3b; T3: X11-246-003-014

POLO CLASSIC (86C, 80)**1.0 (29 kW | 1.0 Liter)**

01.85 → 10.86	GL		246-082-008-014C	SWP-M-C	T1: 1
---------------	----	--	------------------	---------	-------



			VDO		
Datum	Motorcode	Fahrgestell Nr.	Artikel Nr.	Artikelbez.	Information

VW**POLO CLASSIC (86C, 80)****1.0 (33 kW | 1.0 Liter)**

08.86 → 10.90 AAK / AAU / HZ 246-082-008-014C SWP-M-C T1: 1

1.3 (40 kW | 1.3 Liter)

08.85 → 07.86 HK / MH 246-082-008-014C SWP-M-C T1: 1

1.3 KAT (40 kW | 1.3 Liter)

07.87 → 10.90 MH / NZ 246-082-008-014C SWP-M-C T1: 1

1.3 D (33 kW | 1.3 Liter)

08.86 → 12.88 MN 246-082-008-014C SWP-M-C T1: 1

1.4 D (35 kW | 1.4 Liter)

10.90 → 09.94 1W 246-082-008-014C SWP-M-C T1: 1

10.90 → 09.94 1W 246-086-001-007C HLWP T1: 3b

POLO Coupe (86C, 80)**1.0 (29 kW | 1.0 Liter)**

05.82 → 10.86 GL 246-082-008-014C SWP-M-C T1: 1

05.82 → 10.86 GL 246-086-001-007C HLWP T1: 3b

1.0 (33 kW | 1.0 Liter)

08.85 → 01.92 HZ 246-082-008-014C SWP-M-C T1: 1

08.85 → 01.92 HZ 246-086-001-007C HLWP T1: 3b

1.0 KAT (33 kW | 1.0 Liter)

08.89 → 09.94 AAK / AAU / ACM 246-082-008-014C SWP-M-C T1: 1

08.89 → 09.94 AAK / AAU / ACM 246-086-001-007C HLWP T1: 3b

1.1 (37 kW | 1.1 Liter)

10.81 → 07.83 HB 246-082-008-014C SWP-M-C T1: 1

10.81 → 07.83 HB 246-086-001-007C HLWP T1: 3b

1.3 (40 kW | 1.3 Liter)

08.83 → 06.87 HK / MH 246-082-008-014C SWP-M-C T1: 1

08.86 → 06.87 HK / MH 246-083-002-006G SWP-D-C T1: 1

1.3 KAT (40 kW | 1.3 Liter)

10.90 → 08.94 2G / AAV / MH / NZ 246-082-008-014C SWP-M-C T1: 1

10.90 → 08.94 2G / AAV / MH / NZ 246-083-002-014G SWP-D-C T1: 6

10.90 → 08.94 2G / AAV / MH / NZ 246-086-001-002C HLWP T1: 3

1.3 (44 kW | 1.3 Liter)

08.82 → 07.83 HH 246-082-008-014C SWP-M-C T1: 1

1.3 (55 kW | 1.3 Liter)

08.86 → 09.89 GK 246-082-008-014C SWP-M-C T1: 1

08.86 → 09.89 GK 246-083-002-006G SWP-D-C T1: 1

1.3 KAT (55 kW | 1.3 Liter)

10.89 → 09.94 3F 246-082-008-014C SWP-M-C T1: 1

10.89 → 10.90 3F 246-083-002-006G SWP-D-C T1: 1

10.90 → 09.94 3F 246-083-002-014G SWP-D-C T1: 6

10.90 → 09.94 3F 246-086-001-002C HLWP T1: 3



			VDO		
Datum	Motorcode	Fahrgestell Nr.	Artikel Nr.	Artikelbez.	Information

VW**POLO Coupe (86C, 80)****1.3 (57 kW | 1.3 Liter)**

03.91 → 09.94	3F		246-082-008-014C	SWP-M-C	T1: 1
03.91 → 09.94	3F		246-086-001-007C	HLWP	T1: 3b

1.3 G40 (83 kW | 1.3 Liter)

10.90 → 09.94	PY		246-082-008-014C	SWP-M-C	T1: 1
10.90 → 09.94	PY		246-083-002-014G	SWP-D-C	T1: 6
10.90 → 09.94	PY		246-086-001-002C	HLWP	T1: 3

1.3 G40 (85 kW | 1.3 Liter)

01.87 → 08.90	PY		246-082-008-014C	SWP-M-C	T1: 1
01.87 → 08.90	PY		246-083-002-006G	SWP-D-C	T1: 1

1.3 D (33 kW | 1.3 Liter)

08.86 → 08.90	MN		246-082-008-014C	SWP-M-C	T1: 1
08.86 → 08.90	MN		246-083-002-006G	SWP-D-C	T1: 1

1.4 D (35 kW | 1.4 Liter)

10.90 → 09.94	1W		246-082-008-014C	SWP-M-C	T1: 1
10.90 → 09.94	1W		246-083-002-014G	SWP-D-C	T1: 6
10.90 → 09.94	1W		246-086-001-002C	HLWP	T1: 3

POLO Kasten (86CF)**1.0 (33 kW | 1.0 Liter)**

04.93 → 05.96	AAU	→ T - 300 000	246-082-008-014C	SWP-M-C	T1: 1
04.93 → 05.96	AAU	→ T - 300 000	246-083-002-014G	SWP-D-C	T1: 6
05.96 → 06.96	AAU	V - 000 001 →	246-083-002-022G	SWP-D-C	T1: 3
04.93 → 06.96	AAU		246-086-001-002C	HLWP	T1: 3

1.3 (40 kW | 1.3 Liter)

04.93 → 10.94	AAV		246-082-008-014C	SWP-M-C	T1: 1
04.93 → 10.94	AAV		246-083-002-014G	SWP-D-C	T1: 6
04.93 → 10.94	AAV		246-086-001-002C	HLWP	T1: 3

1.4 D (35 kW | 1.4 Liter)

04.93 → 10.94	1W		246-082-008-014C	SWP-M-C	T1: 1
04.93 → 10.94	1W		246-083-002-014G	SWP-D-C	T1: 6
04.93 → 10.94	1W		246-086-001-002C	HLWP	T1: 3

POLO (6N1)**45 1.0 (33 kW | 1.0 Liter)**

10.94 → 09.96	AEV		246-069-056-001Z	N	
10.94 → 09.96	AEV		246-080-010-002Z	N-H	
05.96 → 09.96	AEV	6 N - V - 000 001 →; 6 K - V - 000 001 →	246-083-002-022G	SWP-D-C	T1: 3
10.94 → 09.96	AEV		246-086-001-007C	HLWP	T1: 3b; T3: X11-246-003-014



			VDO		
Datum	Motorcode	Fahrgestell Nr.	Artikel Nr.	Artikelbez.	Information

VW**POLO (6N1)****50 1.0 (37 kW | 1.0 Liter)**

09.96 → 10.99	AER / ALL		246-069-056-001Z	N	
09.96 → 10.99	AER / ALL		246-080-010-002Z	N-H	
09.96 → 10.99	AER / ALL		246-083-002-022G	SWP-D-C	T1: 3
09.96 → 07.98	AER / ALL		246-086-001-002C	HLWP	T1: 3
09.96 → 10.99	AER / ALL		246-086-001-007C	HLWP	T1: 3b; T3: X11-246-003-014

55 1.3 (40 kW | 1.3 Liter)

10.94 → 07.95	ADX		246-069-056-001Z	N	
10.94 → 07.95	ADX		246-080-010-002Z	N-H	
10.94 → 06.95	ADX		246-082-008-014C	SWP-M-C	T1: 1
10.94 → 06.95	ADX		246-083-002-014G	SWP-D-C	T1: 6
10.94 → 06.95	ADX		246-086-001-002C	HLWP	T1: 3
10.94 → 07.95	ADX		246-086-001-007C	HLWP	T1: 3b; T3: X11-246-003-014

55 1.4 (40 kW | 1.4 Liter)

08.95 → 10.99	AEX		246-069-056-001Z	N	
08.95 → 10.99	AEX		246-080-010-002Z	N-H	
08.95 → 05.96	AEX	→ T - 300 000	246-082-008-014C	SWP-M-C	T1: 1
08.95 → 05.96	AEX	→ T - 300 000	246-083-002-014G	SWP-D-C	T1: 6
05.96 → 10.99	AEX	V - 000 001 →	246-083-002-022G	SWP-D-C	T1: 3
08.95 → 12.97	AEX		246-086-001-002C	HLWP	T1: 3
08.95 → 10.99	AEX		246-086-001-007C	HLWP	T1: 3b; T3: X11-246-003-014

60 1.4 (44 kW | 1.4 Liter)

07.95 → 10.99	AEX / AKV / APQ		246-069-056-001Z	N	
07.95 → 10.99	AEX / AKV / APQ		246-080-010-002Z	N-H	
05.96 → 10.99	AEX / AKV / APQ		246-083-002-022G	SWP-D-C	T1: 3
07.96 → 12.97	AEX / AKV / APQ		246-086-001-002C	HLWP	T1: 3
07.95 → 10.99	AEX / AKV / APQ		246-086-001-007C	HLWP	T1: 3b; T3: X11-246-003-014





100 1.4 16V (74 kW | 1.4 Liter)

04.96 → 10.99	AFH		246-069-056-001Z	N	
04.96 → 10.99	AFH		246-080-010-002Z	N-H	
04.96 → 05.96	AFH	→ T - 300 000	246-082-008-014C	SWP-M-C	T1: 1
04.96 → 05.96	AFH	→ T - 300 000	246-083-002-014G	SWP-D-C	T1: 6
05.96 → 10.99	AFH	V - 000 001 →	246-083-002-022G	SWP-D-C	T1: 3
04.96 → 10.99	AFH		246-086-001-002C	HLWP	T1: 3
04.96 → 10.99	AFH		246-086-001-007C	HLWP	T1: 3b; T3: X11-246-003-014

75 1.6 (55 kW | 1.6 Liter)

10.94 → 10.99	AEA / AEE / AHS		246-069-056-001Z	N	
10.94 → 10.99	AEA / AEE / AHS		246-080-010-002Z	N-H	
10.94 → 06.95	AEA / AEE / AHS		246-082-008-014C	SWP-M-C	T1: 1
10.94 → 06.95	AEA / AEE / AHS		246-083-002-014G	SWP-D-C	T1: 6



			VDO		
Datum	Motorcode	Fahrgestell Nr.	Artikel Nr.	Artikelbez.	Information

VW**POLO (6N1)****75 1.6 (55 kW | 1.6 Liter)**

05.96 → 10.99	AEA / AEE / AHS	6 N - V - 000 001 →; 6 K - V - 000 001 →	246-083-002-022G	SWP-D-C	T1: 3
10.94 → 06.95	AEA / AEE / AHS		246-086-001-002C	HLWP	T1: 3
10.94 → 10.99	AEA / AEE / AHS		246-086-001-007C	HLWP	T1: 3b; T3: X11-246-003-014

120 1.6 16V GTI (88 kW | 1.6 Liter)

09.98 → 10.99	AJV		246-069-056-001Z	N	
09.98 → 10.99	AJV		246-080-010-002Z	N-H	
09.98 → 10.99	AJV		246-083-002-022G	SWP-D-C	T1: 3
09.98 → 10.99	AJV		246-086-001-007C	HLWP	T1: 3b; T3: X11-246-003-014

1.7 SDI (42 kW | 1.7 Liter)

04.97 → 10.99	AHG		246-069-056-001Z	N	
04.97 → 10.99	AHG		246-080-010-002Z	N-H	
04.97 → 10.99	AHG		246-083-002-022G	SWP-D-C	T1: 3
04.97 → 10.99	AHG		246-086-001-007C	HLWP	T1: 3b; T3: X11-246-003-014

60 1.7 SDI (44 kW | 1.7 Liter)

08.97 → 10.99	AKU		246-069-056-001Z	N	
08.97 → 10.99	AKU		246-080-010-002Z	N-H	
08.97 → 10.99	AKU	6 N - V - 000 001 →; 6 K - V - 000 001 →	246-083-002-022G	SWP-D-C	T1: 3
08.97 → 10.99	AKU		246-086-001-007C	HLWP	T1: 3b; T3: X11-246-003-014

64 1.9 D (47 kW | 1.9 Liter)

10.94 → 10.99	AEF		246-069-056-001Z	N	
10.94 → 10.99	AEF		246-080-010-002Z	N-H	
01.95 → 05.96	AEF	→ T - 300 000	246-082-008-014C	SWP-M-C	T1: 1
01.95 → 05.96	AEF	→ T - 300 000	246-083-002-014G	SWP-D-C	T1: 6
05.96 → 10.99	AEF	V - 000 001 →	246-083-002-022G	SWP-D-C	T1: 3
01.95 → 10.99	AEF		246-086-001-002C	HLWP	T1: 3
10.94 → 10.99	AEF		246-086-001-007C	HLWP	T1: 3b; T3: X11-246-003-014

64 1.9 SDI (47 kW | 1.9 Liter)

07.96 → 10.99	AGD		246-069-056-001Z	N	
07.96 → 10.99	AGD		246-080-010-002Z	N-H	
07.96 → 10.99	AGD	6 N - V - 000 001 →; 6 K - V - 000 001 →	246-083-002-022G	SWP-D-C	T1: 3
07.96 → 10.99	AGD		246-086-001-007C	HLWP	T1: 3b; T3: X11-246-003-014



			VDO		
Datum	Motorcode	Fahrgestell Nr.	Artikel Nr.	Artikelbez.	Information

VW**POLO Kasten (6NF)****1.0 (33 kW | 1.0 Liter)**

10.94 →	AAU		246-069-056-001Z	N	
07.96 →	AAU		246-083-002-022G	SWP-D-C	T1: 3
07.96 →	AAU		246-086-001-002C	HLWP	T1: 3

1.4 (44 kW | 1.4 Liter)

05.98 →	AEX / APQ		246-069-056-001Z	N	
---------	-----------	--	------------------	---	--

1.7 SDI (44 kW | 1.7 Liter)

08.97 →	AKU		246-069-056-001Z	N	
---------	-----	--	------------------	---	--

1.9 D (47 kW | 1.9 Liter)

10.94 →	AEF		246-069-056-001Z	N	
07.96 →	AEF		246-083-002-022G	SWP-D-C	T1: 3
07.96 →	AEF		246-086-001-002C	HLWP	T1: 3

1.9 SDI (47 kW | 1.9 Liter)

07.96 →	AGD		246-069-056-001Z	N	
---------	-----	--	------------------	---	--

POLO CLASSIC (6KV2)**60 1.4 (44 kW | 1.4 Liter)**

12.95 → 09.01	AEX / AKK / AKV / ANW / ANX / APQ / AUD		246-069-056-001Z	N	
12.95 → 09.01	AEX / AKK / AKV / ANW / ANX / APQ / AUD		246-080-010-002Z	N-H	
05.96 → 09.99	AEX / AKK / AKV / ANW / ANX / APQ / AUD		246-082-008-021G	SWP-M-C	T1: 6
05.96 → 09.99	AEX / AKK / AKV / ANW / ANX / APQ / AUD		246-086-001-002C	HLWP	T1: 3
12.95 → 09.01	AEX / AKK / AKV / ANW / ANX / APQ / AUD		246-086-001-007C	HLWP	T1: 3b; T3: X11-246-003-014

75 1.4 16V (55 kW | 1.4 Liter)

10.99 → 09.01	APE / AUA		246-069-056-001Z	N	
10.99 → 09.01	APE / AUA		246-080-010-002Z	N-H	
10.99 → 09.01	APE / AUA		246-082-008-025G	SWP-M-C	T1: 3
10.99 → 09.01	APE / AUA		246-086-001-002C	HLWP	T1: 3
10.99 → 09.01	APE / AUA		246-086-001-007C	HLWP	T1: 3b; T3: X11-246-003-014

75 1.6 (55 kW | 1.6 Liter)

11.95 → 09.97	1F		246-082-008-021G	SWP-M-C	T1: 6
11.95 → 09.97	1F		246-082-008-025G	SWP-M-C	T1: 3
11.95 → 09.97	1F	6K-Y-502 795 →	246-086-001-007C	HLWP	T1: 3b

100 1.6 (74 kW | 1.6 Liter)

12.95 → 09.01	AEH / AFT / AKL / APF / AUR		246-069-056-001Z	N	
12.95 → 09.01	AEH / AFT / AKL / APF / AUR		246-080-010-002Z	N-H	
05.96 → 09.99	AEH / AFT / AKL / APF / AUR		246-082-008-021G	SWP-M-C	T1: 6
05.96 → 09.99	AEH / AFT / AKL / APF / AUR		246-086-001-002C	HLWP	T1: 3



			VDO		
Datum	Motorcode	Fahrgestell Nr.	Artikel Nr.	Artikelbez.	Information

VW**POLO CLASSIC (6KV2)****100 1.6 (74 kW | 1.6 Liter)**

12.95 → 09.01	AEH / AFT / AKL / APF / AUR		246-086-001-007C	HLWP	T1: 3b; T3: X11-246-003-014
---------------	-----------------------------	--	------------------	------	--------------------------------

75 1.6 (55 kW | 1.6 Liter)

11.95 → 09.01	AEE / ALM		246-069-056-001Z	N	
11.95 → 09.01	AEE / ALM		246-080-010-002Z	N-H	
11.95 → 05.96	AEE / ALM	→ T - 300 000	246-082-008-014C	SWP-M-C	T1: 1
05.96 → 09.99	AEE / ALM		246-082-008-021G	SWP-M-C	T1: 6
11.95 → 05.96	AEE / ALM	→ T - 300 000	246-083-002-014G	SWP-D-C	T1: 6
05.96 → 07.96	AEE / ALM	V - 000 001 →	246-083-002-022G	SWP-D-C	T1: 3
11.95 → 09.99	AEE / ALM		246-086-001-002C	HLWP	T1: 3
11.95 → 09.01	AEE / ALM		246-086-001-007C	HLWP	T1: 3b; T3: X11-246-003-014

90 1.8 (66 kW | 1.8 Liter)

01.97 → 09.01	ADD / ADZ		246-069-056-001Z	N	
01.97 → 09.01	ADD / ADZ		246-080-010-002Z	N-H	
01.97 → 09.01	ADD / ADZ		246-086-001-007C	HLWP	T1: 3b; T3: X11-246-003-014

2.0 (85 kW | 2.0 Liter)

08.99 → 09.01	ADC		246-069-056-001Z	N	
08.99 → 09.01	ADC		246-080-010-002Z	N-H	
08.99 → 09.01	ADC		246-086-001-007C	HLWP	T1: 3b; T3: X11-246-003-014

57 1.7 SDI (42 kW | 1.7 Liter)

07.97 → 09.01	AKW		246-069-056-001Z	N	
07.97 → 09.01	AKW		246-080-010-002Z	N-H	
07.97 → 09.01	AKW		246-086-001-007C	HLWP	T1: 3b; T3: X11-246-003-014

64 1,9 D (47 kW | 1.9 Liter)

01.96 → 10.96	1Y		246-082-008-021G	SWP-M-C	T1: 6
01.96 → 10.96	1Y		246-082-008-025G	SWP-M-C	T1: 3
01.96 → 10.96	1Y	6K-Y-502 795 →	246-086-001-007C	HLWP	T1: 3b

64 1.9 SDI (47 kW | 1.9 Liter)

12.95 → 08.99	1Y / AEU		246-069-056-001Z	N	
12.95 → 08.99	1Y / AEU		246-080-010-002Z	N-H	
05.96 → 08.99	1Y / AEU		246-082-008-021G	SWP-M-C	T1: 6
05.96 → 08.99	1Y / AEU		246-086-001-002C	HLWP	T1: 3
12.95 → 08.99	1Y / AEU		246-086-001-007C	HLWP	T1: 3b; T3: X11-246-003-014

68 1.9 SDI (50 kW | 1.9 Liter)

08.99 → 09.01	AGP / AQM		246-069-056-001Z	N	
08.99 → 09.01	AGP / AQM		246-080-010-002Z	N-H	
10.99 → 09.01	AGP / AQM		246-082-008-025G	SWP-M-C	T1: 3
10.99 → 09.01	AGP / AQM		246-086-001-002C	HLWP	T1: 3



			VDO		
Datum	Motorcode	Fahrgestell Nr.	Artikel Nr.	Artikelbez.	Information

VW**POLO CLASSIC (6KV2)****68 1.9 SDI (50 kW | 1.9 Liter)**

08.99 → 09.01	AGP / AQM		246-086-001-007C	HLWP	T1: 3b; T3: X11-246-003-014
---------------	-----------	--	------------------	------	--------------------------------

90 1.9 TDI (66 kW | 1.9 Liter)

09.96 → 09.01	AGR / AHU / ALE / ALH		246-069-056-001Z	N	
09.96 → 09.01	AGR / AHU / ALE / ALH		246-080-010-002Z	N-H	
09.96 → 09.01	AGR / AHU / ALE / ALH		246-086-001-007C	HLWP	T1: 3b; T3: X11-246-003-014

110 1.9 TDI (81 kW | 1.9 Liter)

06.98 → 09.01	AFN / ASV		246-069-056-001Z	N	
06.98 → 09.01	AFN / ASV		246-080-010-002Z	N-H	
06.98 → 09.99	AFN / ASV		246-082-008-021G	SWP-M-C	T1: 6
06.98 → 09.99	AFN / ASV		246-086-001-002C	HLWP	T1: 3
06.98 → 09.01	AFN / ASV		246-086-001-007C	HLWP	T1: 3b; T3: X11-246-003-014

POLO Variant (6KV5)**1.4 (40 kW | 1.4 Liter)**

12.98 → 09.01	AKP		246-069-056-001Z	N	
12.98 → 09.01	AKP		246-083-002-022G	SWP-D-C	T1: 3

1.4 (44 kW | 1.4 Liter)

05.97 → 09.01	AEX / AKK / AKV / ANW / ANX / APQ / AUD		246-069-056-001Z	N	
05.97 → 09.01	AEX / AKK / AKV / ANW / ANX / APQ / AUD		246-083-002-022G	SWP-D-C	T1: 3

1.4 16V (55 kW | 1.4 Liter)

10.99 → 09.01	APE / AUA		246-069-056-001Z	N	
10.99 → 09.01	APE / AUA		246-083-002-022G	SWP-D-C	T1: 3
10.99 → 09.01	APE / AUA		246-086-001-002C	HLWP	T1: 3

1.6 (55 kW | 1.6 Liter)

05.97 → 09.01	AEE / ALM		246-069-056-001Z	N	
05.97 → 12.98	AEE / ALM		246-083-002-014G	SWP-D-C	T1: 6
05.97 → 09.01	AEE / ALM		246-083-002-022G	SWP-D-C	T1: 3
05.97 → 12.98	AEE / ALM		246-086-001-002C	HLWP	T1: 3

1.6 (74 kW | 1.6 Liter)

05.97 → 09.01	AEH / AFT / AKL / APF / AUR		246-069-056-001Z	N	
05.97 → 05.98	AEH / AFT / AKL / APF / AUR		246-083-002-014G	SWP-D-C	T1: 6
05.97 → 09.01	AEH / AFT / AKL / APF / AUR		246-083-002-022G	SWP-D-C	T1: 3
05.97 → 05.98	AEH / AFT / AKL / APF / AUR		246-086-001-002C	HLWP	T1: 3

1.8 (66 kW | 1.8 Liter)

05.97 → 09.01	ADZ		246-069-056-001Z	N	
05.97 → 09.01	ADZ		246-083-002-022G	SWP-D-C	T1: 3



			VDO		
Datum	Motorcode	Fahrgestell Nr.	Artikel Nr.	Artikelbez.	Information

VW**POLO Variant (6KV5)****1.7 SDI (42 kW | 1.7 Liter)**

08.97 → 09.01	AKW		246-069-056-001Z	N	
08.97 → 09.01	AKW		246-083-002-022G	SWP-D-C	T1: 3

1.9 SDI (47 kW | 1.9 Liter)

06.97 → 09.01	AEY		246-069-056-001Z	N	
06.97 → 05.98	AEY		246-083-002-014G	SWP-D-C	T1: 6
06.97 → 09.01	AEY		246-083-002-022G	SWP-D-C	T1: 3
06.97 → 09.01	AEY		246-086-001-002C	HLWP	T1: 3

1.9 SDI (50 kW | 1.9 Liter)

08.99 → 09.01	AGP / AQM		246-069-056-001Z	N	
10.99 → 09.01	AGP / AQM		246-083-002-022G	SWP-D-C	T1: 3
10.99 → 09.01	AGP / AQM		246-086-001-002C	HLWP	T1: 3

1.9 TDI (66 kW | 1.9 Liter)

05.97 → 09.01	AGR / AHU / ALE / ALH		246-069-056-001Z	N	
05.97 → 09.01	AGR / AHU / ALE / ALH		246-083-002-022G	SWP-D-C	T1: 3

1.9 TDI (81 kW | 1.9 Liter)

06.98 → 09.01	AFN / ASV		246-069-056-001Z	N	
06.98 → 09.01	AFN / ASV		246-083-002-022G	SWP-D-C	T1: 3
06.98 → 09.01	AFN / ASV		246-086-001-002C	HLWP	T1: 3

POLO (6N2)**1.0 (37 kW | 1.0 Liter)**

10.99 → 09.01	ALD / AUC		246-069-056-001Z	N	
10.99 → 09.01	ALD / AUC		246-083-002-022G	SWP-D-C	T1: 3
10.99 → 09.01	ALD / AUC		246-086-001-002C	HLWP	T1: 3

1.4 (40 kW | 1.4 Liter)

10.99 → 09.01	AKP		246-069-056-001Z	N	
10.99 → 09.01	AKP		246-083-002-022G	SWP-D-C	T1: 3
10.99 → 09.01	AKP		246-086-001-002C	HLWP	T1: 3

1.4 (44 kW | 1.4 Liter)

10.99 → 09.01	AKK / AUD		246-069-056-001Z	N	
10.99 → 09.01	AKK / AUD		246-083-002-022G	SWP-D-C	T1: 3
10.99 → 09.01	AKK / AUD		246-086-001-002C	HLWP	T1: 3

1.4 16V (55 kW | 1.4 Liter)

10.99 → 09.01	AHW / AUA		246-069-056-001Z	N	
10.99 → 09.01	AHW / AUA		246-083-002-022G	SWP-D-C	T1: 3
10.99 → 09.01	AHW / AUA		246-086-001-002C	HLWP	T1: 3

1.4 16V (74 kW | 1.4 Liter)

10.99 → 09.01	AFK / AUB		246-069-056-001Z	N	
10.99 → 09.01	AFK / AUB		246-083-002-022G	SWP-D-C	T1: 3
10.99 → 09.01	AFK / AUB		246-086-001-002C	HLWP	T1: 3



			VDO		
Datum	Motorcode	Fahrgestell Nr.	Artikel Nr.	Artikelbez.	Information

VW**POLO (6N2)****1.6 16V GTI (92 kW | 1.6 Liter)**

10.99 → 09.01	ARC / AVY		246-069-056-001Z	N	
11.99 → 09.01	ARC / AVY		246-083-002-022G	SWP-D-C	T1: 3
11.99 → 09.01	ARC / AVY		246-086-001-002C	HLWP	T1: 3

1.4 TDI (55 kW | 1.4 Liter)

10.99 → 09.01	AMF		246-069-056-001Z	N	
10.99 → 09.01	AMF		246-083-002-022G	SWP-D-C	T1: 3
10.99 → 09.01	AMF		246-086-001-002C	HLWP	T1: 3

1.7 SDI (44 kW | 1.7 Liter)

10.99 → 09.01	AKU		246-069-056-001Z	N	
10.99 → 09.01	AKU		246-083-002-022G	SWP-D-C	T1: 3
10.99 → 09.01	AKU		246-086-001-002C	HLWP	T1: 3

1.9 D (47 kW | 1.9 Liter)

10.99 → 09.01	AEF		246-069-056-001Z	N	
10.99 → 09.01	AEF		246-083-002-022G	SWP-D-C	T1: 3
10.99 → 09.01	AEF		246-086-001-002C	HLWP	T1: 3

1.9 SDI (47 kW | 1.9 Liter)

10.99 → 09.01	AGD / ASX		246-069-056-001Z	N	
10.99 → 09.01	AGD / ASX		246-083-002-022G	SWP-D-C	T1: 3
10.99 → 09.01	AGD / ASX		246-086-001-002C	HLWP	T1: 3

POLO (9N_)**1.2 (40 kW | 1.2 Liter)**

01.02 →	AWY / BMD		246-082-008-025G	SWP-M-C	T1: 3
01.02 →	AWY / BMD		246-083-002-022G	SWP-D-C	T1: 3

1.2 (47 kW | 1.2 Liter)

10.01 →	AZQ / BME		246-082-008-025G	SWP-M-C	T1: 3
10.01 →	AZQ / BME		246-083-002-022G	SWP-D-C	T1: 3

1.4 16V (55 kW | 1.4 Liter)

10.01 →	AUA / BBY / BKY		246-082-008-025G	SWP-M-C	T1: 3
10.01 →	AUA / BBY / BKY		246-083-002-022G	SWP-D-C	T1: 3

1.4 FSI (63 kW | 1.4 Liter)

05.02 →	AXU		246-082-008-025G	SWP-M-C	T1: 3
05.02 →	AXU		246-083-002-022G	SWP-D-C	T1: 3

1.4 16V (74 kW | 1.4 Liter)

10.01 →	AUB / BBZ		246-082-008-025G	SWP-M-C	T1: 3
10.01 →	AUB / BBZ		246-083-002-022G	SWP-D-C	T1: 3

1.4 TDI (51 kW | 1.4 Liter)

04.05 →	BNM		246-082-008-025G	SWP-M-C	T1: 3
04.05 →	BNM	9N-2-000 001 →	246-083-002-022G	SWP-D-C	T1: 3
04.05 →	BNM	9N-2-000 001 →	246-086-001-007C	HLWP	T1: 3b

1.4 TDI (55 kW | 1.4 Liter)

10.01 →	AMF / BAY		246-082-008-025G	SWP-M-C	T1: 3
10.01 →	AMF / BAY		246-083-002-022G	SWP-D-C	T1: 3



			VDO		
Datum	Motorcode	Fahrgestell Nr.	Artikel Nr.	Artikelbez.	Information

VW**POLO (9N_)****1.4 TDI (59 kW | 1.4 Liter)**

04.05 →	BMS / BNV		246-082-008-025G	SWP-M-C	T1: 3
04.05 →	BMS / BNV	9N-2-000 001 →	246-083-002-022G	SWP-D-C	T1: 3
04.05 →	BMS / BNV	9N-2-000 001 →	246-086-001-007C	HLWP	T1: 3b

1.9 SDI (47 kW | 1.9 Liter)

10.01 →	ASY		246-082-008-025G	SWP-M-C	T1: 3
10.01 →	ASY		246-083-002-022G	SWP-D-C	T1: 3

1.9 TDI (74 kW | 1.9 Liter)

10.01 →	ATD / AXR		246-082-008-025G	SWP-M-C	T1: 3
10.01 →	ATD / AXR		246-083-002-022G	SWP-D-C	T1: 3

1.9 TDI (96 kW | 1.9 Liter)

11.03 →	ASZ / BLT		246-082-008-025G	SWP-M-C	T1: 3
11.03 →	ASZ / BLT	9N-2-000 001 →	246-083-002-022G	SWP-D-C	T1: 3
11.03 →	ASZ / BLT	9N-2-000 001 →	246-086-001-007C	HLWP	T1: 3b

POLO Stufenheck**1.4 (55 kW | 1.4 Liter)**

07.03 →	BBY		246-082-008-025G	SWP-M-C	T1: 3
07.03 →	BBY	9N-2-000 001 →	246-083-002-022G	SWP-D-C	T1: 3
07.03 →	BBY	9N-2-000 001 →	246-086-001-007C	HLWP	T1: 3b

1.4 (74 kW | 1.4 Liter)

11.03 →	BBZ		246-082-008-025G	SWP-M-C	T1: 3
11.03 →	BBZ	9N-2-000 001 →	246-083-002-022G	SWP-D-C	T1: 3
11.03 →	BBZ	9N-2-000 001 →	246-086-001-007C	HLWP	T1: 3b

1.4 TDI (55 kW | 1.4 Liter)

07.03 →	BAY		246-082-008-025G	SWP-M-C	T1: 3
07.03 →	BAY	9N-2-000 001 →	246-083-002-022G	SWP-D-C	T1: 3
07.03 →	BAY	9N-2-000 001 →	246-086-001-007C	HLWP	T1: 3b

1.9 SDI (47 kW | 1.9 Liter)

11.03 →	ASY		246-082-008-025G	SWP-M-C	T1: 3
11.03 →	ASY	9N-2-000 001 →	246-083-002-022G	SWP-D-C	T1: 3
11.03 →	ASY	9N-2-000 001 →	246-086-001-007C	HLWP	T1: 3b

SANTANA (32B)**1.3 (44 kW | 1.3 Liter)**

08.81 → 07.83	FZ		246-086-001-007C	HLWP	T1: 3b; T3: X11-246-003-014
---------------	----	--	------------------	------	--------------------------------

1.6 (55 kW | 1.6 Liter)

08.81 → 12.84	WV		246-082-008-014C	SWP-M-C	T1: 1
08.81 → 12.84	WV		246-086-001-007C	HLWP	T1: 3b; T3: X11-246-003-014



			VDO		
Datum	Motorcode	Fahrgestell Nr.	Artikel Nr.	Artikelbez.	Information

VW**SANTANA (32B)****1.6 (63 kW | 1.6 Liter)**

08.81 → 12.82	YP		246-082-008-014C	SWP-M-C	T1: 1
08.81 → 12.82	YP		246-086-001-007C	HLWP	T1: 3b; T3: X11-246-003-014

1.8 (66 kW | 1.8 Liter)

01.83 → 12.84	DS		246-082-008-014C	SWP-M-C	T1: 1
01.83 → 12.84	DS		246-086-001-007C	HLWP	T1: 3b; T3: X11-246-003-014

1.9 (85 kW | 1.9 Liter)

08.81 → 07.83	WN		246-082-008-014C	SWP-M-C	T1: 1
08.81 → 07.83	WN		246-086-001-007C	HLWP	T1: 3b; T3: X11-246-003-014

2.0 (85 kW | 2.0 Liter)

08.83 → 12.84	HP / JS		246-082-008-014C	SWP-M-C	T1: 1
08.83 → 12.84	HP / JS		246-086-001-007C	HLWP	T1: 3b; T3: X11-246-003-014

2.1 (85 kW | 2.1 Liter)

08.82 → 12.83	WE		246-086-001-007C	HLWP	T1: 3b; T3: X11-246-003-014
---------------	----	--	------------------	------	--------------------------------

1.6 D (40 kW | 1.6 Liter)

08.81 → 12.84	CR / JK		246-082-008-014C	SWP-M-C	T1: 1
08.81 → 12.84	CR / JK		246-086-001-007C	HLWP	T1: 3b; T3: X11-246-003-014

1.6 TD (51 kW | 1.6 Liter)

12.81 → 07.84	CY		246-082-008-014C	SWP-M-C	T1: 1
12.81 → 12.84	CY		246-086-001-007C	HLWP	T1: 3b; T3: X11-246-003-014

SCIROCCO (53)**1.1 (37 kW | 1.1 Liter)**

04.74 → 01.77	FA	→ 537 2037 126	246-075-021-006C	SWP-M-G	T1: 1; T2: B
01.77 → 07.79	FA	537 2037 127 →	246-082-008-014C	SWP-M-C	T1: 1

1.3 (44 kW | 1.3 Liter)

08.79 → 07.80	GF		246-082-008-014C	SWP-M-C	T1: 1
---------------	----	--	------------------	---------	-------

1.5 (51 kW | 1.5 Liter)

08.77 → 07.80	JB		246-082-008-014C	SWP-M-C	T1: 1
---------------	----	--	------------------	---------	-------

1.5 (51 kW | 1.5 Liter)

02.74 → 12.75	FH		246-075-021-006C	SWP-M-G	T1: 1; T2: B
---------------	----	--	------------------	---------	--------------

1.5 (55 kW | 1.5 Liter)

02.74 → 08.75	YJ / ZB		246-075-021-006C	SWP-M-G	T1: 1; T2: B
---------------	---------	--	------------------	---------	--------------

1.5 (63 kW | 1.5 Liter)

02.74 → 09.75	ZC		246-075-021-006C	SWP-M-G	T1: 1; T2: B
---------------	----	--	------------------	---------	--------------



			VDO		
Datum	Motorcode	Fahrgestell Nr.	Artikel Nr.	Artikelbez.	Information

VW**SCIROCCO (53)****1.6 (55 kW | 1.6 Liter)**

08.75 → 01.77	FN / FP	→ 537 2037 126	246-075-021-006C	SWP-M-G	T1: 1; T2: B
01.77 → 07.77	FN / FP	537 2037 127 →	246-082-008-014C	SWP-M-C	T1: 1

1.6 (63 kW | 1.6 Liter)

08.75 → 01.77	FR	→ 537 2037 126	246-075-021-006C	SWP-M-G	T1: 1; T2: B
08.76 → 07.80	FR	537 2037 127 →	246-082-008-014C	SWP-M-C	T1: 1

1.6 (81 kW | 1.6 Liter)

08.76 → 01.77	EG	→ 537 2037 126	246-075-021-006C	SWP-M-G	T1: 1; T2: B
01.77 → 07.80	EG	537 2037 127 →	246-082-008-014C	SWP-M-C	T1: 1

SCIROCCO (53B)**1.3 (44 kW | 1.3 Liter)**

08.81 → 07.83	GF		246-082-008-014C	SWP-M-C	T1: 1
08.80 → 12.83	GF		246-086-001-007C	HLWP	T1: 3b; T3: X11-246-003-014

1.5 (51 kW | 1.5 Liter)

08.81 → 07.83	JB		246-082-008-014C	SWP-M-C	T1: 1
08.80 → 12.83	JB		246-086-001-007C	HLWP	T1: 3b; T3: X11-246-003-014

1.6 (55 kW | 1.6 Liter)

01.83 → 12.89	EW		246-082-008-014C	SWP-M-C	T1: 1
01.83 → 12.89	EW		246-086-001-007C	HLWP	T1: 3b; T3: X11-246-003-014

1.6 (63 kW | 1.6 Liter)

08.80 → 07.83	FR		246-082-008-014C	SWP-M-C	T1: 1
08.80 → 04.84	FR		246-086-001-007C	HLWP	T1: 3b; T3: X11-246-003-014

1.6 (81 kW | 1.6 Liter)

08.80 → 07.82	EG		246-086-001-007C	HLWP	T1: 3b; T3: X11-246-003-014
---------------	----	--	------------------	------	--------------------------------

1.6 (53 kW | 1.6 Liter)

04.86 → 07.90	RE		246-086-001-007C	HLWP	T1: 3b; T3: X11-246-003-014
---------------	----	--	------------------	------	--------------------------------

1.8 (66 kW | 1.8 Liter)

08.83 → 07.90	EX		246-082-008-014C	SWP-M-C	T1: 1
08.83 → 07.92	EX		246-086-001-007C	HLWP	T1: 3b; T3: X11-246-003-014

1.8 (70 kW | 1.8 Liter)

11.85 → 07.92	JH		246-082-008-014C	SWP-M-C	T1: 1
11.85 → 07.92	JH		246-086-001-007C	HLWP	T1: 3b; T3: X11-246-003-014



			VDO		
Datum	Motorcode	Fahrgestell Nr.	Artikel Nr.	Artikelbez.	Information

VW**SCIROCCO (53B)****1.8 (82 kW | 1.8 Liter)**

08.82 → 07.87	DX / EV / JJ / PB		246-082-008-014C	SWP-M-C	T1: 1
08.82 → 12.89	DX / EV / JJ / PB		246-086-001-007C	HLWP	T1: 3b; T3: X11-246-003-014

1.8 16V (95 kW | 1.8 Liter)

03.86 → 07.90	PL		246-082-008-014C	SWP-M-C	T1: 1
03.86 → 07.92	PL		246-086-001-007C	HLWP	T1: 3b; T3: X11-246-003-014

1.8 16V (102 kW | 1.8 Liter)

10.85 → 07.89	KR		246-082-008-014C	SWP-M-C	T1: 1
10.85 → 07.89	KR		246-086-001-007C	HLWP	T1: 3b; T3: X11-246-003-014

SHARAN (7M8, 7M9, 7M6)**1.8 T 20V (110 kW | 1.8 Liter)**

11.97 →	AJH / AWC		246-083-002-014G	SWP-D-C	T1: 6
04.00 →	AJH / AWC	- 1 - 000 001 →	246-083-002-022G	SWP-D-C	T1: 3
11.97 →	AJH / AWC		246-086-001-002C	HLWP	T1: 3
09.97 →	AJH / AWC		246-086-001-007C	HLWP	T1: 3b; T3: X11-246-003-014

2.0 (85 kW | 2.0 Liter)

09.95 →	ADY / ATM		246-083-002-014G	SWP-D-C	T1: 6
04.00 →	ADY / ATM	- 1 - 000 001 →	246-083-002-022G	SWP-D-C	T1: 3
09.95 →	ADY / ATM		246-086-001-002C	HLWP	T1: 3
09.95 →	ADY / ATM		246-086-001-007C	HLWP	T1: 3b; T3: X11-246-003-014

2.8 VR6 (128 kW | 2.8 Liter)

09.95 → 03.98	AAA / AMY		246-083-002-014G	SWP-D-C	T1: 6
04.00 → 04.00	AAA / AMY	- 1 - 000 001 →	246-083-002-022G	SWP-D-C	T1: 3
09.95 → 03.98	AAA / AMY		246-086-001-002C	HLWP	T1: 3
09.95 → 04.00	AAA / AMY		246-086-001-007C	HLWP	T1: 3b; T3: X11-246-003-014

2.8 VR6 Syncro (128 kW | 2.8 Liter)

04.00 → 04.00	AAA / AMY	- 1 - 000 001 →	246-083-002-022G	SWP-D-C	T1: 3
11.96 → 04.00	AAA / AMY		246-086-001-007C	HLWP	T1: 3b; T3: X11-246-003-014

2.8 V6 24V (150 kW | 2.8 Liter)

04.00 →	AYL	- 1 - 000 001 →	246-083-002-022G	SWP-D-C	T1: 3
04.00 →	AYL		246-086-001-007C	HLWP	T1: 3b; T3: X11-246-003-014

2.8 V6 24V 4motion (150 kW | 2.8 Liter)

04.00 →	AYL	- 1 - 000 001 →	246-083-002-022G	SWP-D-C	T1: 3
04.00 →	AYL		246-086-001-007C	HLWP	T1: 3b; T3: X11-246-003-014



			VDO		
Datum	Motorcode	Fahrgestell Nr.	Artikel Nr.	Artikelbez.	Information

VW**SHARAN (7M8, 7M9, 7M6)****1.9 TDI (66 kW | 1.9 Liter)**

09.95 → 06.96	1Z / AHU / ANU		246-083-002-014G	SWP-D-C	T1: 6
04.00 →	1Z / AHU / ANU	- 1 - 000 001 →	246-083-002-022G	SWP-D-C	T1: 3
09.95 → 06.96	1Z / AHU / ANU		246-086-001-002C	HLWP	T1: 3
09.95 →	1Z / AHU / ANU		246-086-001-007C	HLWP	T1: 3b; T3: X11-246-003-014

1.9 TDI (81 kW | 1.9 Liter)

09.96 → 04.00	AFN / AVG		246-083-002-014G	SWP-D-C	T1: 6
04.00 → 04.00	AFN / AVG	- 1 - 000 001 →	246-083-002-022G	SWP-D-C	T1: 3
09.96 → 04.00	AFN / AVG		246-086-001-002C	HLWP	T1: 3
09.96 → 04.00	AFN / AVG		246-086-001-007C	HLWP	T1: 3b; T3: X11-246-003-014

1.9 TDI (85 kW | 1.9 Liter)

04.00 →	AUY	- 1 - 000 001 →	246-083-002-022G	SWP-D-C	T1: 3
04.00 →	AUY		246-086-001-007C	HLWP	T1: 3b; T3: X11-246-003-014

1.9 TDI 4motion (85 kW | 1.9 Liter)

04.00 →	AUY	- 1 - 000 001 →	246-083-002-022G	SWP-D-C	T1: 3
04.00 →	AUY		246-086-001-007C	HLWP	T1: 3b; T3: X11-246-003-014

1.9 TDI (96 kW | 1.9 Liter)

11.02 →	ASZ		246-083-002-022G	SWP-D-C	T1: 3
11.02 →	ASZ		246-086-001-007C	HLWP	T1: 3b

1.9 TDI (110 kW | 1.9 Liter)

06.05 →	BTB		246-083-002-022G	SWP-D-C	T1: 3
06.05 →	BTB		246-086-001-007C	HLWP	T1: 3b

TOUAREG (7LA)**3.2 V6 (162 kW | 3.2 Liter)**

10.02 →	AZZ / BKJ		246-083-002-022G	SWP-D-C	T1: 3
10.02 →	AZZ / BKJ		246-086-001-007C	HLWP	T1: 3b; T3: X11-246-003-014

3.2 V6 (177 kW | 3.2 Liter)

11.04 →			246-083-002-022G	SWP-D-C	T1: 3
11.04 →			246-086-001-007C	HLWP	T1: 3b

4.2 V8 (228 kW | 4.2 Liter)

12.02 →	AXQ / BHX		246-083-002-022G	SWP-D-C	T1: 3
12.02 →	AXQ / BHX		246-086-001-007C	HLWP	T1: 3b

2.5 R5 TDI (128 kW | 2.5 Liter)

01.03 →	BAC		246-083-002-022G	SWP-D-C	T1: 3
01.03 →	BAC		246-086-001-007C	HLWP	T1: 3b

3.0 V6 TDI (165 kW | 3.0 Liter)

11.04 →	BKS		246-083-002-022G	SWP-D-C	T1: 3
11.04 →	BKS		246-086-001-007C	HLWP	T1: 3b



			VDO		
Datum	Motorcode	Fahrgestell Nr.	Artikel Nr.	Artikelbez.	Information

VW**TOUAREG (7LA)****5.0 V10 TDI (230 kW | 5.0 Liter)**

10.02 →	AYH		246-083-002-022G	SWP-D-C	T1: 3
10.02 →	AYH		246-086-001-007C	HLWP	T1: 3b; T3: X11-246-003-014

6.0 W12 (331 kW | 6.0 Liter)

03.05 →			246-083-002-022G	SWP-D-C	T1: 3
03.05 →			246-086-001-007C	HLWP	T1: 3b

TOURAN**1.6 (75 kW | 1.6 Liter)**

07.03 →	BGU / BLF / BSF		246-083-002-022G	SWP-D-C	T1: 3
07.03 →	BGU / BSE / BSF		246-086-001-007C	HLWP	T1: 3b

1.6 FSI (85 kW | 1.6 Liter)

02.03 →	BAG / BLF / BLP		246-083-002-022G	SWP-D-C	T1: 3
02.03 →	BAG / BLF / BLP		246-086-001-007C	HLWP	T1: 3b

2.0 FSI (110 kW | 2.0 Liter)

10.03 →	AXW / BLR / BLX / BLY		246-083-002-022G	SWP-D-C	T1: 3
10.03 →	AXW / BLR / BLX / BLY		246-086-001-007C	HLWP	T1: 3b

1.9 TDI (66 kW | 1.9 Liter)

11.04 →	BRU		246-083-002-022G	SWP-D-C	T1: 3
11.04 →	BRU		246-086-001-007C	HLWP	T1: 3b

1.9 TDI (74 kW | 1.9 Liter)

02.03 →	AVQ		246-086-001-007C	HLWP	T1: 3b
---------	-----	--	------------------	------	--------

1.9 TDI (77 kW | 1.9 Liter)

08.03 →	BKC		246-083-002-022G	SWP-D-C	T1: 3
08.03 →	BKC		246-086-001-007C	HLWP	T1: 3b

2.0 TDI (100 kW | 2.0 Liter)

02.03 →	AZV		246-083-002-022G	SWP-D-C	T1: 3
02.03 →	AZV		246-086-001-007C	HLWP	T1: 3b

2.0 TDI (103 kW | 2.0 Liter)

08.03 →	BKD / BMM		246-083-002-022G	SWP-D-C	T1: 3
---------	-----------	--	------------------	---------	-------

VENTO (1H2)**1.4 (40 kW | 1.4 Liter)**

11.91 → 09.98	ABD / AEX		246-069-056-001Z	N	
01.92 → 09.98	ABD / AEX		246-080-010-002Z	N-H	T7: CL →
11.91 → 07.95	ABD / AEX		246-082-008-021G	SWP-M-C	T1: 6
11.91 → 07.95	ABD / AEX		246-083-002-014G	SWP-D-C	T1: 6
11.91 → 09.98	ABD / AEX		246-086-001-007C	HLWP	T1: 3b; T3: X11-246-003-014



			VDO		
Datum	Motorcode	Fahrgestell Nr.	Artikel Nr.	Artikelbez.	Information

VW**VENTO (1H2)****1.4 (44 kW | 1.4 Liter)**

11.91 → 09.98	ABD / AEX		246-069-056-001Z	N	
01.92 → 09.98	ABD / AEX		246-080-010-002Z	N-H	T7: CL →
07.95 → 12.97	ABD / AEX		246-082-008-021G	SWP-M-C	T1: 6
07.95 → 12.97	ABD / AEX		246-083-002-014G	SWP-D-C	T1: 6
11.91 → 09.98	ABD / AEX		246-086-001-007C	HLWP	T1: 3b; T3: X11-246-003-014

1.6 (55 kW | 1.6 Liter)

09.92 → 09.98	ABU / AEA / AEE		246-069-056-001Z	N	
09.92 → 09.98	ABU / AEA / AEE		246-080-010-002Z	N-H	T7: CL →
09.92 → 12.97	ABU / AEA / AEE		246-082-008-021G	SWP-M-C	T1: 6
09.92 → 12.97	ABU / AEA / AEE		246-083-002-014G	SWP-D-C	T1: 6
09.92 → 09.98	ABU / AEA / AEE		246-086-001-007C	HLWP	T1: 3b; T3: X11-246-003-014

1.6 (74 kW | 1.6 Liter)

10.94 → 09.98	AEK / AFT		246-069-056-001Z	N	
10.94 → 09.98	AEK / AFT		246-080-010-002Z	N-H	T7: CL →
10.94 → 12.97	AEK / AFT		246-082-008-021G	SWP-M-C	T1: 6
10.94 → 12.97	AEK / AFT		246-083-002-014G	SWP-D-C	T1: 6
10.94 → 09.98	AEK / AFT		246-086-001-007C	HLWP	T1: 3b; T3: X11-246-003-014

1.8 (55 kW | 1.8 Liter)

11.91 → 09.98	AAM		246-069-056-001Z	N	
01.92 → 09.98	AAM		246-080-010-002Z	N-H	T7: CL →
11.91 → 12.97	AAM		246-082-008-021G	SWP-M-C	T1: 6
11.91 → 12.97	AAM		246-083-002-014G	SWP-D-C	T1: 6
11.91 → 09.98	AAM		246-086-001-007C	HLWP	T1: 3b; T3: X11-246-003-014

1.8 (66 kW | 1.8 Liter)

11.91 → 09.98	ABS / ADZ		246-069-056-001Z	N	
01.92 → 09.98	ABS / ADZ		246-080-010-002Z	N-H	T7: CL →
11.91 → 12.97	ABS / ADZ		246-082-008-021G	SWP-M-C	T1: 6
11.91 → 12.97	ABS / ADZ		246-083-002-014G	SWP-D-C	T1: 6
11.91 → 09.98	ABS / ADZ		246-086-001-007C	HLWP	T1: 3b; T3: X11-246-003-014

2.0 (85 kW | 2.0 Liter)

11.91 → 09.98	2E / ADY / AGG / AKR		246-069-056-001Z	N	
01.92 → 09.98	2E / ADY / AGG / AKR		246-080-010-002Z	N-H	T7: CL →
11.91 → 12.97	2E / ADY / AGG / AKR		246-082-008-021G	SWP-M-C	T1: 6
11.91 → 12.97	2E / ADY / AGG / AKR		246-083-002-014G	SWP-D-C	T1: 6
11.91 → 09.98	2E / ADY / AGG / AKR		246-086-001-007C	HLWP	T1: 3b; T3: X11-246-003-014



			VDO		
Datum	Motorcode	Fahrgestell Nr.	Artikel Nr.	Artikelbez.	Information

VW**VENTO (1H2)****2.8 VR6 (128 kW | 2.8 Liter)**

01.92 → 09.98	AAA		246-069-056-001Z	N	
01.92 → 09.98	AAA		246-080-010-002Z	N-H	T7: CL →
01.92 → 12.97	AAA		246-082-008-021G	SWP-M-C	T1: 6
01.92 → 12.97	AAA		246-083-002-014G	SWP-D-C	T1: 6
01.92 → 09.98	AAA		246-086-001-007C	HLWP	T1: 3b; T3: X11-246-003-014

1.9 SDI (47 kW | 1.9 Liter)

04.97 → 09.98	AEY		246-069-056-001Z	N	
04.97 → 09.98	AEY		246-080-010-002Z	N-H	T7: CL →
04.97 → 12.97	AEY		246-082-008-021G	SWP-M-C	T1: 6
04.97 → 12.97	AEY		246-083-002-014G	SWP-D-C	T1: 6
04.97 → 09.98	AEY		246-086-001-007C	HLWP	T1: 3b; T3: X11-246-003-014

1.9 D (48 kW | 1.9 Liter)

11.91 → 09.98	1Y		246-069-056-001Z	N	
01.92 → 09.98	1Y		246-080-010-002Z	N-H	T7: CL →
11.91 → 12.97	1Y		246-082-008-021G	SWP-M-C	T1: 6
11.91 → 12.97	1Y		246-083-002-014G	SWP-D-C	T1: 6
11.91 → 09.98	1Y		246-086-001-007C	HLWP	T1: 3b; T3: X11-246-003-014

1.9 TD (55 kW | 1.9 Liter)

11.91 → 09.98	AAZ		246-069-056-001Z	N	
01.92 → 09.98	AAZ		246-080-010-002Z	N-H	T7: CL →
11.91 → 12.97	AAZ		246-082-008-021G	SWP-M-C	T1: 6
11.91 → 12.97	AAZ		246-083-002-014G	SWP-D-C	T1: 6
11.91 → 09.98	AAZ		246-086-001-007C	HLWP	T1: 3b; T3: X11-246-003-014

1.9 TDI (66 kW | 1.9 Liter)

09.93 → 09.98	1Z / AHU / ALE		246-069-056-001Z	N	
09.93 → 09.98	1Z / AHU / ALE		246-080-010-002Z	N-H	T7: CL →
09.93 → 12.97	1Z / AHU / ALE		246-082-008-021G	SWP-M-C	T1: 6
09.93 → 12.97	1Z / AHU / ALE		246-083-002-014G	SWP-D-C	T1: 6
09.93 → 09.98	1Z / AHU / ALE		246-086-001-007C	HLWP	T1: 3b; T3: X11-246-003-014

1.9 TDI (81 kW | 1.9 Liter)

04.96 → 09.98	AFN		246-069-056-001Z	N	
04.96 → 09.98	AFN		246-080-010-002Z	N-H	T7: CL →
04.96 → 12.97	AFN		246-082-008-021G	SWP-M-C	T1: 6
04.96 → 12.97	AFN		246-083-002-014G	SWP-D-C	T1: 6
04.96 → 09.98	AFN		246-086-001-007C	HLWP	T1: 3b; T3: X11-246-003-014



			VDO		
Datum	Motorcode	Fahrgestell Nr.	Artikel Nr.	Artikelbez.	Information

VW**1500,1600 Variant (36)****1.5 (33 kW | 1.5 Liter)**

04.61 → 07.73	K		246-075-021-006C	SWP-M-G	T1: 1; T2: B
---------------	---	--	------------------	---------	--------------

1.6 L (40 kW | 1.6 Liter)

08.65 → 07.73	T / U		246-075-021-006C	SWP-M-G	T1: 1; T2: B
---------------	-------	--	------------------	---------	--------------

LT 28 I Bus (281-363)**2.0 (55 kW | 2.0 Liter)**

04.75 → 08.77	CH	→ 287 2600 000	246-075-021-006C	SWP-M-G	T1: 1; T2: B
---------------	----	----------------	------------------	---------	--------------

08.77 → 11.82	CH	287 2600 001 →	246-082-008-014C	SWP-M-C	T1: 1
---------------	----	----------------	------------------	---------	-------

2.4 (66 kW | 2.4 Liter)

12.82 → 07.92	DL		246-082-008-014C	SWP-M-C	T1: 1
---------------	----	--	------------------	---------	-------

2.4 i (69 kW | 2.4 Liter)

08.89 → 06.96	1E		246-082-008-014C	SWP-M-C	T1: 1
---------------	----	--	------------------	---------	-------

2.4 D (51 kW | 2.4 Liter)

08.89 → 07.92	1S / ACT		246-082-008-014C	SWP-M-C	T1: 1
---------------	----------	--	------------------	---------	-------

2.4 D (55 kW | 2.4 Liter)

01.79 → 07.92	CP / DW	28-D-007 274 →	246-086-001-007C	HLWP	T1: 3b
---------------	---------	----------------	------------------	------	--------

2.4 TD (68 kW | 2.4 Liter)

08.89 → 08.92	1G	28-D-007 274 →	246-086-001-007C	HLWP	T1: 3b
---------------	----	----------------	------------------	------	--------

2.4 TD (70 kW | 2.4 Liter)

09.92 → 06.96	ACL	28-D-007 274 →	246-086-001-007C	HLWP	T1: 3b
---------------	-----	----------------	------------------	------	--------

2.4 TD (75 kW | 2.4 Liter)

12.82 → 07.89	DV		246-082-008-014C	SWP-M-C	T1: 1
---------------	----	--	------------------	---------	-------

LT 28-35 I Kasten (281-363)**2.0 (55 kW | 2.0 Liter)**

04.75 → 09.83	CH	28-D-007-274 →	246-075-021-006C	SWP-M-G	T1: 1; T2: B
---------------	----	----------------	------------------	---------	--------------

04.75 → 09.83	CH	28-D-007 274 →	246-086-001-007C	HLWP	T1: 3b
---------------	----	----------------	------------------	------	--------

2.4 (66 kW | 2.4 Liter)

12.82 → 07.92	DL	28-D-007 274 →	246-086-001-007C	HLWP	T1: 3b
---------------	----	----------------	------------------	------	--------

2.4 i (69 kW | 2.4 Liter)

03.94 → 06.96	1E		246-082-008-014C	SWP-M-C	T1: 1
---------------	----	--	------------------	---------	-------

03.94 → 06.96	1E	- P - 000 001 →	246-086-001-007C	HLWP	T1: 3b; T3: X11-246-003-014
---------------	----	-----------------	------------------	------	--------------------------------

2.4 D (51 kW | 2.4 Liter)

08.92 → 05.96	1S / ACT		246-082-008-014C	SWP-M-C	T1: 1
---------------	----------	--	------------------	---------	-------

08.92 → 05.96	1S / ACT	- P - 000 001 →	246-086-001-007C	HLWP	T1: 3b; T3: X11-246-003-014
---------------	----------	-----------------	------------------	------	--------------------------------

2.4 D (55 kW | 2.4 Liter)

01.79 → 07.92	CP / DW	28-D-007 274 →	246-086-001-007C	HLWP	T1: 3b
---------------	---------	----------------	------------------	------	--------

2.4 TD (68 kW | 2.4 Liter)

08.92 → 08.92	1G	- P - 000 001 →	246-086-001-007C	HLWP	T1: 3b; T3: X11-246-003-014
---------------	----	-----------------	------------------	------	--------------------------------



			VDO		
Datum	Motorcode	Fahrgestell Nr.	Artikel Nr.	Artikelbez.	Information

VW**LT 28-35 I Kasten (281-363)****2.4 TD (70 kW | 2.4 Liter)**

08.92 → 05.96	ACL	- P - 000 001 →	246-086-001-007C	HLWP	T1: 3b; T3: X11-246-003-014
---------------	-----	-----------------	------------------	------	--------------------------------

2.4 TD (75 kW | 2.4 Liter)

08.92 → 08.92	DV	- P - 000 001 →	246-086-001-007C	HLWP	T1: 3b; T3: X11-246-003-014
---------------	----	-----------------	------------------	------	--------------------------------

2.7 D (48 kW | 2.7 Liter)

01.76 → 08.77	CG	→ 287 2600 000	246-075-021-006C	SWP-M-G	T1: 1; T2: B
08.77 → 01.80	CG	287 2600 001 →	246-082-008-014C	SWP-M-C	T1: 1

LT 40-55 I Kasten (291-512)**2.0 (55 kW | 2.0 Liter)**

08.78 → 11.82	CH		246-082-008-014C	SWP-M-C	T1: 1
---------------	----	--	------------------	---------	-------

2.4 D (51 kW | 2.4 Liter)

07.90 → 07.92	1S / ACT		246-082-008-014C	SWP-M-C	T1: 1
---------------	----------	--	------------------	---------	-------

2.4 TD (68 kW | 2.4 Liter)

10.88 → 08.92	1G		246-082-008-014C	SWP-M-C	T1: 1
---------------	----	--	------------------	---------	-------

2.4 TD (75 kW | 2.4 Liter)

02.86 → 08.92	DV		246-082-008-014C	SWP-M-C	T1: 1
---------------	----	--	------------------	---------	-------

2.4 TD 4WD (75 kW | 2.4 Liter)

08.85 → 03.86	DV		246-082-008-014C	SWP-M-C	T1: 1
---------------	----	--	------------------	---------	-------

LT 28-35 I Pritsche/Fahrgestell (281-363)**2.0 (55 kW | 2.0 Liter)**

12.82 → 09.83	CH	- D - 007 274 →	246-086-001-007C	HLWP	T1: 3b; T3: X11-246-003-014
---------------	----	-----------------	------------------	------	--------------------------------

2.4 (66 kW | 2.4 Liter)

08.88 → 07.92	DL		246-082-008-014C	SWP-M-C	T1: 1
12.82 → 07.92	DL	- D - 007 274 →	246-086-001-007C	HLWP	T1: 3b; T3: X11-246-003-014

2.4 i (69 kW | 2.4 Liter)

03.94 → 06.96	1E		246-082-008-014C	SWP-M-C	T1: 1
03.94 → 06.96	1E	- D - 007 274 →	246-086-001-007C	HLWP	T1: 3b; T3: X11-246-003-014

2.4 D (51 kW | 2.4 Liter)

08.90 → 06.96	1S / ACT	- D - 007 274 →	246-086-001-007C	HLWP	T1: 3b; T3: X11-246-003-014
---------------	----------	-----------------	------------------	------	--------------------------------

2.4 D (55 kW | 2.4 Liter)

01.79 → 02.91	CP / DW		246-082-008-014C	SWP-M-C	T1: 1
12.82 → 02.91	CP / DW	- D - 007 274 →	246-086-001-007C	HLWP	T1: 3b; T3: X11-246-003-014



			VDO		
Datum	Motorcode	Fahrgestell Nr.	Artikel Nr.	Artikelbez.	Information

VW**LT 28-35 I Pritsche/Fahrgestell (281-363)**

2.4 TD (68 kW 2.4 Liter)					
08.90 → 08.92	1G	- D - 007 274 →	246-086-001-007C	HLWP	T1: 3b; T3: X11-246-003-014
2.4 TD (70 kW 2.4 Liter)					
09.92 → 06.96	ACL		246-082-008-014C	SWP-M-C	T1: 1
08.92 → 06.96	ACL	- D - 007 274 →	246-086-001-007C	HLWP	T1: 3b; T3: X11-246-003-014
2.4 TD (75 kW 2.4 Liter)					
12.82 → 07.92	DV		246-082-008-014C	SWP-M-C	T1: 1
12.82 → 09.93	DV	- D - 007 274 →	246-086-001-007C	HLWP	T1: 3b; T3: X11-246-003-014
2.7 D (48 kW 2.7 Liter)					
11.75 → 01.80	CG	28-D-007-274 →	246-075-021-006C	SWP-M-G	T1: 1; T2: B
11.75 → 01.80	CG	28-D-007 274 →	246-086-001-007C	HLWP	T1: 3b





LT 40-55 I Pritsche/Fahrgestell (293-909)

2.0 (55 kW 2.0 Liter)					
04.75 → 09.83	CH		246-075-021-006C	SWP-M-G	T1: 1; T2: B

LT 28-35 II Bus (2DM)

2.3 (105 kW 2.3 Liter)					
05.96 →	AGL		246-082-008-014C	SWP-M-C	T1: 1
05.96 →	AGL		246-086-001-007C	HLWP	T1: 3b
2.5 SDI (55 kW 2.5 Liter)					
07.96 →	AGX		246-082-008-014C	SWP-M-C	T1: 1
07.96 →	AGX		246-086-001-007C	HLWP	T1: 3b
2.5 TDI (61 kW 2.5 Liter)					
05.01 →	BBE		246-082-008-014C	SWP-M-C	T1: 1
05.01 →	BBE		246-086-001-007C	HLWP	T1: 3b
2.5 TDI (66 kW 2.5 Liter)					
05.99 →	APA		246-082-008-014C	SWP-M-C	T1: 1
05.99 →	APA		246-086-001-007C	HLWP	T1: 3b
2.5 TDI (70 kW 2.5 Liter)					
05.01 →	BBF		246-082-008-014C	SWP-M-C	T1: 1
05.01 →	BBF		246-086-001-007C	HLWP	T1: 3b
2.5 TDI (75 kW 2.5 Liter)					
05.96 → 08.99	AHD		246-082-008-014C	SWP-M-C	T1: 1
05.96 → 08.99	AHD		246-086-001-007C	HLWP	T1: 3b
2.5 TDI (80 kW 2.5 Liter)					
05.99 →	ANJ / AVR		246-082-008-014C	SWP-M-C	T1: 1
05.99 →	ANJ / AVR		246-086-001-007C	HLWP	T1: 3b



			VDO		
Datum	Motorcode	Fahrgestell Nr.	Artikel Nr.	Artikelbez.	Information

VW**LT 28-46 II Kasten (2DX0AE)****2.3 (105 kW | 2.3 Liter)**

05.96 →	AGL		246-082-008-014C	SWP-M-C	T1: 1
05.96 →	AGL		246-086-001-002C	HLWP	T1: 3
05.96 →	AGL		246-086-001-007C	HLWP	T1: 3b; T3: X11-246-003-014

2.5 SDI (55 kW | 2.5 Liter)

09.96 →	AGX		246-086-001-007C	HLWP	T1: 3b; T3: X11-246-003-014
---------	-----	--	------------------	------	--------------------------------

2.5 TDI (61 kW | 2.5 Liter)

05.01 →	BBE		246-086-001-007C	HLWP	T1: 3b; T3: X11-246-003-014
---------	-----	--	------------------	------	--------------------------------

2.5 TDI (66 kW | 2.5 Liter)

05.99 →	APA		246-086-001-007C	HLWP	T1: 3b; T3: X11-246-003-014
---------	-----	--	------------------	------	--------------------------------

2.5 TDI (70 kW | 2.5 Liter)

05.01 →	BBF		246-086-001-007C	HLWP	T1: 3b; T3: X11-246-003-014
---------	-----	--	------------------	------	--------------------------------

2.5 TDI (75 kW | 2.5 Liter)

05.96 → 04.97	AHD		246-082-008-014C	SWP-M-C	T1: 1
05.96 → 04.97	AHD		246-086-001-002C	HLWP	T1: 3
05.96 → 08.99	AHD		246-086-001-007C	HLWP	T1: 3b; T3: X11-246-003-014

2.5 TDI (80 kW | 2.5 Liter)

05.99 →	ANJ / AVR		246-086-001-007C	HLWP	T1: 3b; T3: X11-246-003-014
---------	-----------	--	------------------	------	--------------------------------

2.8 TDI (92 kW | 2.8 Liter)

06.97 → 09.98	AGK		246-082-008-014C	SWP-M-C	T1: 1
06.97 → 09.98	AGK		246-086-001-002C	HLWP	T1: 3
06.97 → 12.98	AGK		246-086-001-007C	HLWP	T1: 3b; T3: X11-246-003-014

2.8 TDI (96 kW | 2.8 Liter)

01.99 →	ATA		246-086-001-007C	HLWP	T1: 3b; T3: X11-246-003-014
---------	-----	--	------------------	------	--------------------------------

2.8 TDI (116 kW | 2.8 Liter)

04.02 →	AUH		246-086-001-007C	HLWP	T1: 3b; T3: X11-246-003-014
---------	-----	--	------------------	------	--------------------------------

LT 28-46 II Pritsche/Fahrgestell (2DX0FE)**2.3 (105 kW | 2.3 Liter)**

06.96 →	AGL		246-082-008-014C	SWP-M-C	T1: 1
06.96 →	AGL		246-086-001-002C	HLWP	T1: 3

2.5 SDI (55 kW | 2.5 Liter)

09.96 →	AGX		246-082-008-014C	SWP-M-C	T1: 1
09.96 →	AGX		246-086-001-002C	HLWP	T1: 3



			VDO		
Datum	Motorcode	Fahrgestell Nr.	Artikel Nr.	Artikelbez.	Information

VW**LT 28-46 II Pritsche/Fahrgestell (2DX0FE)**

2.5 TDI (61 kW 2.5 Liter)					
05.01 →	BBE		246-082-008-014C	SWP-M-C	T1: 1
05.01 →	BBE		246-086-001-007C	HLWP	T1: 3b
2.5 TDI (66 kW 2.5 Liter)					
05.99 →	APA		246-082-008-014C	SWP-M-C	T1: 1
05.99 →	APA		246-086-001-007C	HLWP	T1: 3b
2.5 TDI (70 kW 2.5 Liter)					
05.01 →	BBF		246-082-008-014C	SWP-M-C	T1: 1
05.01 →	BBF		246-086-001-007C	HLWP	T1: 3b
2.5 TDI (75 kW 2.5 Liter)					
06.96 → 08.99	AHD		246-082-008-014C	SWP-M-C	T1: 1
06.96 → 08.99	AHD		246-086-001-007C	HLWP	T1: 3b
2.5 TDI (80 kW 2.5 Liter)					
05.99 →	ANJ / AVR		246-082-008-014C	SWP-M-C	T1: 1
05.99 →	ANJ / AVR		246-086-001-007C	HLWP	T1: 3b
2.8 TDI (92 kW 2.8 Liter)					
06.97 → 12.98	AGK		246-082-008-014C	SWP-M-C	T1: 1
06.97 → 12.98	AGK		246-086-001-007C	HLWP	T1: 3b
2.8 TDI (96 kW 2.8 Liter)					
01.99 →	ATA		246-082-008-014C	SWP-M-C	T1: 1
01.99 →	ATA		246-086-001-007C	HLWP	T1: 3b
2.8 TDI (116 kW 2.8 Liter)					
04.02 →	AUH		246-082-008-014C	SWP-M-C	T1: 1
04.02 →	AUH		246-086-001-007C	HLWP	T1: 3b

TRANSPORTER T2 Bus

1.6 (34 kW 1.6 Liter)					
08.67 → 07.70	AF		246-075-021-006C	SWP-M-G	T1: 1; T2: B
08.67 → 07.70	AF		246-086-001-007C	HLWP	T1: 3b
1.6 (37 kW 1.6 Liter)					
08.70 → 04.79	AD / AH / AS		246-086-001-007C	HLWP	T1: 3b
1.7 (49 kW 1.7 Liter)					
08.71 → 10.73	CA / CB		246-086-001-007C	HLWP	T1: 3b
1.8 (50 kW 1.8 Liter)					
11.73 → 07.75	AP		246-086-001-007C	HLWP	T1: 3b
2.0 (51 kW 2.0 Liter)					
08.75 → 04.79	CJ / GD / GE		246-086-001-007C	HLWP	T1: 3b

TRANSPORTER T2 Kasten

1.6 (37 kW 1.6 Liter)					
08.70 → 04.79	AD / AE / AS		246-086-001-007C	HLWP	T1: 3b
1.7 (49 kW 1.7 Liter)					
08.71 → 12.73	CA / CB		246-086-001-007C	HLWP	T1: 3b



			VDO		
Datum	Motorcode	Fahrgestell Nr.	Artikel Nr.	Artikelbez.	Information

VW**TRANSPORTER T2 Kasten****1.8 (50 kW | 1.8 Liter)**

11.73 → 07.75	AP		246-086-001-007C	HLWP	T1: 3b
---------------	----	--	------------------	------	--------

2.0 (51 kW | 2.0 Liter)

08.75 → 07.79	CJ / GD / GE		246-086-001-007C	HLWP	T1: 3b
---------------	--------------	--	------------------	------	--------

TRANSPORTER T2 Pritsche/Fahrgestell**1.6 (37 kW | 1.6 Liter)**

08.68 → 07.79	AD / AS		246-075-021-006C	SWP-M-G	T1: 1; T2: B
---------------	---------	--	------------------	---------	--------------

08.68 → 07.79	AD / AS		246-086-001-007C	HLWP	T1: 3b
---------------	---------	--	------------------	------	--------

TRANSPORTER T3 Bus**1.6 (37 kW | 1.6 Liter)**

05.79 → 12.82	CT		246-082-008-014C	SWP-M-C	T1: 1
---------------	----	--	------------------	---------	-------

05.79 → 12.82	CT		246-086-001-007C	HLWP	T1: 3b; T3: X11-246-003-014
---------------	----	--	------------------	------	--------------------------------

1.9 (44 kW | 1.9 Liter)

08.82 → 07.92	DF		246-086-001-007C	HLWP	T1: 3b; T3: X11-246-003-014
---------------	----	--	------------------	------	--------------------------------

1.9 (57 kW | 1.9 Liter)

08.82 → 07.92	DG		246-086-001-007C	HLWP	T1: 3b; T3: X11-246-003-014
---------------	----	--	------------------	------	--------------------------------

1.9 Syncro (57 kW | 1.9 Liter)

02.85 → 07.91	DG		246-082-008-014C	SWP-M-C	T1: 1
---------------	----	--	------------------	---------	-------

02.85 → 07.92	DG		246-086-001-007C	HLWP	T1: 3b; T3: X11-246-003-014
---------------	----	--	------------------	------	--------------------------------

1.9 (61 kW | 1.9 Liter)

01.83 → 07.85	DH		246-082-008-014C	SWP-M-C	T1: 1
---------------	----	--	------------------	---------	-------

01.83 → 07.85	DH		246-086-001-007C	HLWP	T1: 3b; T3: X11-246-003-014
---------------	----	--	------------------	------	--------------------------------

1.9 (66 kW | 1.9 Liter)

08.83 → 07.85	GW		246-086-001-007C	HLWP	T1: 3b; T3: X11-246-003-014
---------------	----	--	------------------	------	--------------------------------

2.0 (51 kW | 2.0 Liter)

05.79 → 12.82	CU / CV		246-082-008-014C	SWP-M-C	T1: 1
---------------	---------	--	------------------	---------	-------

05.79 → 12.82	CU / CV		246-086-001-007C	HLWP	T1: 3b; T3: X11-246-003-014
---------------	---------	--	------------------	------	--------------------------------

2.1 (64 kW | 2.1 Liter)

10.86 → 07.91	SR		246-082-008-014C	SWP-M-C	T1: 1
---------------	----	--	------------------	---------	-------

10.86 → 07.92	SR		246-086-001-007C	HLWP	T1: 3b; T3: X11-246-003-014
---------------	----	--	------------------	------	--------------------------------



			VDO		
Datum	Motorcode	Fahrgestell Nr.	Artikel Nr.	Artikelbez.	Information





VW**TRANSPORTER T3 Bus**

2.1 Syncro (64 kW 2.1 Liter)					
10.86 → 08.91	SR		246-082-008-014C	SWP-M-C	T1: 1
10.86 → 07.92	SR		246-086-001-007C	HLWP	T1: 3b; T3: X11-246-003-014
2.1 i (68 kW 2.1 Liter)					
07.89 → 07.92	SS		246-086-001-007C	HLWP	T1: 3b; T3: X11-246-003-014
2.1 (70 kW 2.1 Liter)					
06.89 → 07.92	MV		246-086-001-007C	HLWP	T1: 3b; T3: X11-246-003-014
2.1 (70 kW 2.1 Liter)					
08.85 → 07.92	MV		246-086-001-007C	HLWP	T1: 3b; T3: X11-246-003-014
2.1 Syncro (70 kW 2.1 Liter)					
08.85 → 09.91	MV		246-082-008-014C	SWP-M-C	T1: 1
08.85 → 07.92	MV		246-086-001-007C	HLWP	T1: 3b; T3: X11-246-003-014
2.1 (82 kW 2.1 Liter)					
08.85 → 07.92	DJ		246-086-001-007C	HLWP	T1: 3b; T3: X11-246-003-014
2.1 Syncro (82 kW 2.1 Liter)					
01.86 → 07.92	DJ		246-086-001-007C	HLWP	T1: 3b; T3: X11-246-003-014
1.6 D (37 kW 1.6 Liter)					
01.81 → 07.87	CS		246-086-001-007C	HLWP	T1: 3b; T3: X11-246-003-014
1.6 TD (51 kW 1.6 Liter)					
08.84 → 07.91	JX		246-082-008-014C	SWP-M-C	T1: 1
08.84 → 07.92	JX		246-086-001-007C	HLWP	T1: 3b; T3: X11-246-003-014
1.6 TD Syncro (51 kW 1.6 Liter)					
03.86 → 09.91	JX		246-082-008-014C	SWP-M-C	T1: 1
03.86 → 07.92	JX		246-086-001-007C	HLWP	T1: 3b; T3: X11-246-003-014
1.7 D (42 kW 1.7 Liter)					
10.86 → 07.91	KY		246-082-008-014C	SWP-M-C	T1: 1
10.86 → 07.92	KY		246-086-001-007C	HLWP	T1: 3b; T3: X11-246-003-014

TRANSPORTER T3 Kasten

1.9 (44 kW 1.9 Liter)					
08.85 → 07.91	DF		246-082-008-014C	SWP-M-C	T1: 1
1.9 Syncro (57 kW 1.9 Liter)					
11.84 → 07.91	DG		246-082-008-014C	SWP-M-C	T1: 1



			VDO		
Datum	Motorcode	Fahrgestell Nr.	Artikel Nr.	Artikelbez.	Information

VW**TRANSPORTER T3 Kasten****1.9 (66 kW | 1.9 Liter)**

08.83 → 07.85 | GW | 246-082-008-014C | SWP-M-C | T1: 1

2.0 (51 kW | 2.0 Liter)

05.79 → 12.82 | CU | 246-082-008-014C | SWP-M-C | T1: 1

1.6 TD Syncro (51 kW | 1.6 Liter)

03.86 → 09.91 | JX | 246-082-008-014C | SWP-M-C | T1: 1

TRANSPORTER T3 Pritsche/Fahrgestell**1.9 (44 kW | 1.9 Liter)**

09.82 → 07.91 | DF | 246-082-008-014C | SWP-M-C | T1: 1

09.82 → 07.92 | DF | 246-086-001-007C | HLWP | T1: 3b; T3:
X11-246-003-014**1.9 (57 kW | 1.9 Liter)**

08.82 → 07.91 | DG | 246-082-008-014C | SWP-M-C | T1: 1

08.82 → 07.92 | DG | 246-086-001-007C | HLWP | T1: 3b; T3:
X11-246-003-014**1.9 Syncro (57 kW | 1.9 Liter)**12.84 → 07.92 | DG | 246-086-001-007C | HLWP | T1: 3b; T3:
X11-246-003-014**2.0 (51 kW | 2.0 Liter)**05.79 → 04.86 | CU | 246-086-001-007C | HLWP | T1: 3b; T3:
X11-246-003-014**2.1 i (68 kW | 2.1 Liter)**

07.89 → 07.91 | SS | 246-082-008-014C | SWP-M-C | T1: 1

07.89 → 07.92 | SS | 246-086-001-007C | HLWP | T1: 3b; T3:
X11-246-003-014**2.1 (70 kW | 2.1 Liter)**03.86 → 07.92 | MV | 246-086-001-007C | HLWP | T1: 3b; T3:
X11-246-003-014**2.1 Syncro (70 kW | 2.1 Liter)**03.86 → 07.92 | MV | 246-086-001-007C | HLWP | T1: 3b; T3:
X11-246-003-014**2.1 (82 kW | 2.1 Liter)**

03.86 → 09.91 | DJ | 246-082-008-014C | SWP-M-C | T1: 1

03.86 → 07.92 | DJ | 246-086-001-007C | HLWP | T1: 3b; T3:
X11-246-003-014**2.1 Syncro (82 kW | 2.1 Liter)**03.86 → 07.92 | DJ | 246-086-001-007C | HLWP | T1: 3b; T3:
X11-246-003-014**1.6 D (37 kW | 1.6 Liter)**

01.81 → 07.87 | CS | 246-082-008-014C | SWP-M-C | T1: 1

01.81 → 07.87 | CS | 246-086-001-007C | HLWP | T1: 3b; T3:
X11-246-003-014



			VDO		
Datum	Motorcode	Fahrgestell Nr.	Artikel Nr.	Artikelbez.	Information

VW**TRANSPORTER T3 Pritsche/Fahrgestell****1.6 TD (51 kW | 1.6 Liter)**

10.84 → 07.92	JX		246-086-001-007C	HLWP	T1: 3b; T3: X11-246-003-014
---------------	----	--	------------------	------	--------------------------------

1.6 TD Syncro (51 kW | 1.6 Liter)

03.86 → 07.92	JX		246-086-001-007C	HLWP	T1: 3b; T3: X11-246-003-014
---------------	----	--	------------------	------	--------------------------------

1.7 D (42 kW | 1.7 Liter)

07.89 → 07.92	KY		246-086-001-007C	HLWP	T1: 3b; T3: X11-246-003-014
---------------	----	--	------------------	------	--------------------------------

TRANSPORTER T4 Bus (70XB, 70XC, 7DB, 7DW)**1.8 (49 kW | 1.8 Liter)**

12.90 → 07.92	PD		246-069-056-001Z	N	
12.90 → 07.92	PD		246-080-010-002Z	N-H	
12.90 → 07.92	PD		246-082-008-014C	SWP-M-C	T1: 1
12.90 → 07.92	PD		246-083-002-014G	SWP-D-C	T1: 6
12.90 → 07.92	PD		246-086-001-002C	HLWP	T1: 3
12.90 → 07.92	PD		246-086-001-007C	HLWP	T1: 3b; T3: X11-246-003-014

2.0 (62 kW | 2.0 Liter)

09.90 →	AAC		246-069-056-001Z	N	
09.90 →	AAC		246-080-010-002Z	N-H	
09.90 → 12.95	AAC		246-082-008-014C	SWP-M-C	T1: 1
09.90 → 12.95	AAC		246-083-002-014G	SWP-D-C	T1: 6
09.90 → 12.95	AAC		246-086-001-002C	HLWP	T1: 3
09.90 →	AAC		246-086-001-007C	HLWP	T1: 3b; T3: X11-246-003-014

2.5 (81 kW | 2.5 Liter)

11.90 →	AAF / ACU / AEN / AEU		246-069-056-001Z	N	
11.90 →	AAF / ACU / AEN / AEU		246-080-010-002Z	N-H	
11.90 → 12.93	AAF / ACU / AEN / AEU		246-082-008-014C	SWP-M-C	T1: 1
11.90 → 12.93	AAF / ACU / AEN / AEU		246-083-002-014G	SWP-D-C	T1: 6
11.90 → 12.93	AAF / ACU / AEN / AEU		246-086-001-002C	HLWP	T1: 3
11.90 →	AAF / ACU / AEN / AEU		246-086-001-007C	HLWP	T1: 3b; T3: X11-246-003-014

2.5 Syncro (81 kW | 2.5 Liter)

11.92 →	AAF / ACU / AEN / AEU		246-069-056-001Z	N	
11.92 →	AAF / ACU / AEN / AEU		246-080-010-002Z	N-H	
11.92 → 06.95	AAF / ACU / AEN / AEU		246-082-008-014C	SWP-M-C	T1: 1
11.92 →	AAF / ACU / AEN / AEU		246-083-002-006G	SWP-D-C	T1: 1
11.92 →	AAF / ACU / AEN / AEU		246-086-001-007C	HLWP	T1: 3b; T3: X11-246-003-014



			VDO		
Datum	Motorcode	Fahrgestell Nr.	Artikel Nr.	Artikelbez.	Information

VW**TRANSPORTER T4 Bus (70XB, 70XC, 7DB, 7DW)****2.5 (85 kW | 2.5 Liter)**

08.96 →	AET / APL / AVT		246-069-056-001Z	N	
08.96 →	AET / APL / AVT		246-080-010-002Z	N-H	
08.96 →	AET / APL / AVT		246-086-001-007C	HLWP	T1: 3b; T3: X11-246-003-014

2.5 Syncro (85 kW | 2.5 Liter)

07.96 →	AET / APL / AVT		246-069-056-001Z	N	
07.96 →	AET / APL / AVT		246-080-010-002Z	N-H	
07.96 → 05.97	AET / APL / AVT		246-082-008-014C	SWP-M-C	T1: 1
07.96 → 05.97	AET / APL / AVT		246-083-002-014G	SWP-D-C	T1: 6
07.96 → 05.97	AET / APL / AVT		246-086-001-002C	HLWP	T1: 3
07.96 →	AET / APL / AVT		246-086-001-007C	HLWP	T1: 3b; T3: X11-246-003-014

2.8 VR 6 (103 kW | 2.8 Liter)

11.95 → 04.00	AES		246-069-056-001Z	N	
11.95 → 04.00	AES		246-080-010-002Z	N-H	
01.96 → 04.96	AES		246-082-008-014C	SWP-M-C	T1: 1
01.96 → 04.96	AES		246-083-002-014G	SWP-D-C	T1: 6
01.96 → 05.97	AES	→ W - 000 001	246-086-001-002C	HLWP	T1: 3
05.97 → 04.00	AES	W - 000 001 →	246-086-001-007C	HLWP	T1: 3b; T3: X11-246-003-014

2.8 V6 (150 kW | 2.8 Liter)

04.00 →	AMV		246-069-056-001Z	N	
04.00 →	AMV		246-080-010-002Z	N-H	
04.00 →	AMV		246-086-001-007C	HLWP	T1: 3b; T3: X11-246-003-014

1.9 D (44 kW | 1.9 Liter)

09.90 →	1X		246-069-056-001Z	N	
09.90 →	1X		246-080-010-002Z	N-H	
09.90 → 12.94	1X		246-082-008-014C	SWP-M-C	T1: 1
09.90 → 12.94	1X		246-083-002-014G	SWP-D-C	T1: 6
09.90 → 12.94	1X		246-086-001-002C	HLWP	T1: 3
09.90 →	1X		246-086-001-007C	HLWP	T1: 3b; T3: X11-246-003-014

1.9 TD (50 kW | 1.9 Liter)

10.92 →	ABL		246-069-056-001Z	N	
10.92 →	ABL		246-080-010-002Z	N-H	
01.96 → 06.97	ABL		246-082-008-014C	SWP-M-C	T1: 1
01.96 → 06.97	ABL		246-083-002-014G	SWP-D-C	T1: 6
01.96 → 05.97	ABL	→ W - 000 001	246-086-001-002C	HLWP	T1: 3
05.97 → 06.97	ABL	W - 000 001 →	246-086-001-007C	HLWP	T1: 3b; T3: X11-246-003-014



			VDO		
Datum	Motorcode	Fahrgestell Nr.	Artikel Nr.	Artikelbez.	Information

VW**TRANSPORTER T4 Bus (70XB, 70XC, 7DB, 7DW)****2.4 D (55 kW | 2.4 Liter)**

08.97 →	AJA		246-069-056-001Z	N	
08.97 →	AJA		246-080-010-002Z	N-H	
08.97 →	AJA		246-083-002-006G	SWP-D-C	T1: 1

2.4 D (57 kW | 2.4 Liter)

09.90 →	AAB		246-069-056-001Z	N	
09.90 →	AAB		246-080-010-002Z	N-H	
09.90 → 12.95	AAB		246-082-008-014C	SWP-M-C	T1: 1
09.90 → 12.95	AAB		246-083-002-014G	SWP-D-C	T1: 6
09.90 → 12.95	AAB		246-086-001-002C	HLWP	T1: 3
09.90 →	AAB		246-086-001-007C	HLWP	T1: 3b; T3: X11-246-003-014

2.4 D Syncro (57 kW | 2.4 Liter)

10.92 →	AAB		246-069-056-001Z	N	
10.92 →	AAB		246-080-010-002Z	N-H	
11.92 → 06.95	AAB		246-082-008-014C	SWP-M-C	T1: 1
11.92 →	AAB		246-083-002-006G	SWP-D-C	T1: 1
10.92 →	AAB		246-086-001-007C	HLWP	T1: 3b; T3: X11-246-003-014

2.5 TDI (65 kW | 2.5 Liter)

05.98 →	AJT / AYY		246-069-056-001Z	N	
05.98 →	AJT / AYY		246-080-010-002Z	N-H	
05.98 →	AJT / AYY		246-086-001-007C	HLWP	T1: 3b; T3: X11-246-003-014

2.5 TDI (75 kW | 2.5 Liter)

09.95 →	ACV / AUF / AYC		246-069-056-001Z	N	
09.95 →	ACV / AUF / AYC		246-080-010-002Z	N-H	
01.96 →	ACV / AUF / AYC		246-082-008-014C	SWP-M-C	T1: 1
01.96 →	ACV / AUF / AYC		246-083-002-014G	SWP-D-C	T1: 6
01.96 → 05.97	ACV / AUF / AYC	→ W - 000 001	246-086-001-002C	HLWP	T1: 3
05.97 →	ACV / AUF / AYC	W - 000 001 →	246-086-001-007C	HLWP	T1: 3b; T3: X11-246-003-014

2.5 TDI Syncro (75 kW | 2.5 Liter)

01.96 →	ACV / AXL		246-069-056-001Z	N	
01.96 →	ACV / AXL		246-080-010-002Z	N-H	
01.96 → 04.98	ACV / AXL		246-082-008-014C	SWP-M-C	T1: 1
01.96 → 04.98	ACV / AXL		246-083-002-014G	SWP-D-C	T1: 6
01.96 → 04.98	ACV / AXL	→ W - 000 001	246-086-001-002C	HLWP	T1: 3
05.97 →	ACV / AXL	W - 000 001 →	246-086-001-007C	HLWP	T1: 3b; T3: X11-246-003-014

2.5 TDI (111 kW | 2.5 Liter)

05.98 →	AHY / AXG		246-069-056-001Z	N	
05.98 →	AHY / AXG		246-080-010-002Z	N-H	
05.98 →	AHY / AXG		246-086-001-007C	HLWP	T1: 3b; T3: X11-246-003-014



			VDO		
Datum	Motorcode	Fahrgestell Nr.	Artikel Nr.	Artikelbez.	Information

VW**TRANSPORTER T4 Kasten (70XA)****2.0 (62 kW | 2.0 Liter)**

09.90 →	AAC		246-080-010-002Z	N-H	
09.90 → 12.95	AAC		246-082-008-014C	SWP-M-C	T1: 1
09.90 → 12.95	AAC		246-083-002-014G	SWP-D-C	T1: 6
09.90 → 12.95	AAC		246-086-001-002C	HLWP	T1: 3

2.5 (81 kW | 2.5 Liter)

11.90 →	AAF / ACU / AEN / AEU		246-080-010-002Z	N-H	
---------	-----------------------	--	------------------	-----	--

2.5 Syncro (81 kW | 2.5 Liter)

10.92 →	AAF / ACU / AEN / AEU		246-080-010-002Z	N-H	
---------	-----------------------	--	------------------	-----	--

2.5 (85 kW | 2.5 Liter)

08.96 →	AET / APL / AVT		246-080-010-002Z	N-H	
---------	-----------------	--	------------------	-----	--

2.5 Syncro (85 kW | 2.5 Liter)

08.96 →	AET / APL / AVT		246-080-010-002Z	N-H	
08.96 → 05.97	AET / APL / AVT		246-082-008-014C	SWP-M-C	T1: 1
08.96 → 05.97	AET / APL / AVT		246-083-002-014G	SWP-D-C	T1: 6
08.96 → 05.97	AET / APL / AVT		246-086-001-002C	HLWP	T1: 3

1.9 D (45 kW | 1.9 Liter)

09.90 →	1X		246-080-010-002Z	N-H	
---------	----	--	------------------	-----	--

1.9 TD (50 kW | 1.9 Liter)

10.92 →	ABL		246-080-010-002Z	N-H	
10.92 → 12.95	ABL		246-082-008-014C	SWP-M-C	T1: 1
10.92 → 12.95	ABL		246-083-002-014G	SWP-D-C	T1: 6
10.92 → 12.95	ABL		246-086-001-002C	HLWP	T1: 3

2.4 D (55 kW | 2.4 Liter)

08.97 →	AJA		246-080-010-002Z	N-H	
---------	-----	--	------------------	-----	--

2.4 D (57 kW | 2.4 Liter)

09.90 →	AAB		246-080-010-002Z	N-H	
---------	-----	--	------------------	-----	--

2.4 D Syncro (57 kW | 2.4 Liter)

10.92 →	AAB		246-080-010-002Z	N-H	
---------	-----	--	------------------	-----	--

2.5 TDI (65 kW | 2.5 Liter)

12.98 →	AJT / AYY		246-080-010-002Z	N-H	
---------	-----------	--	------------------	-----	--

2.5 TDI (75 kW | 2.5 Liter)

09.95 →	ACV / AUF / AYC		246-080-010-002Z	N-H	
01.96 →	ACV / AUF / AYC		246-082-008-014C	SWP-M-C	T1: 1
01.96 →	ACV / AUF / AYC		246-083-002-014G	SWP-D-C	T1: 6
01.96 → 05.97	ACV / AUF / AYC	→ W - 000 001	246-086-001-002C	HLWP	T1: 3
05.97 →	ACV / AUF / AYC	W - 000 001 →	246-086-001-007C	HLWP	T1: 3b; T3: X11-246-003-014

2.5 TDI Syncro (75 kW | 2.5 Liter)

09.95 →	ACV / AXL		246-080-010-002Z	N-H	
05.98 →	ACV / AXL		246-082-008-014C	SWP-M-C	T1: 1
05.98 →	ACV / AXL		246-083-002-014G	SWP-D-C	T1: 6
05.98 →	ACV / AXL		246-086-001-002C	HLWP	T1: 3



			VDO		
Datum	Motorcode	Fahrgestell Nr.	Artikel Nr.	Artikelbez.	Information

VW**TRANSPORTER T4 Kasten (70XA)****2.5 TDI (111 kW | 2.5 Liter)**

09.00 →	AXG		246-082-008-014C	SWP-M-C	T1: 1
09.00 →	AXG		246-086-001-007C	HLWP	T1: 3b

TRANSPORTER T4 Pritsche/Fahrgestell (70XD)**2.0 (62 kW | 2.0 Liter)**

07.90 →	AAC		246-069-056-001Z	N	
09.90 →	AAC		246-080-010-002Z	N-H	
09.90 → 12.95	AAC		246-082-008-014C	SWP-M-C	T1: 1
09.90 → 12.95	AAC		246-086-001-002C	HLWP	T1: 3

2.5 (81 kW | 2.5 Liter)

11.90 →	AAF / ACU / AEN / AEU		246-069-056-001Z	N	
11.90 →	AAF / ACU / AEN / AEU		246-080-010-002Z	N-H	

2.5 Syncro (81 kW | 2.5 Liter)

10.92 →	AAF / ACU / AEN / AEU		246-069-056-001Z	N	
10.92 →	AAF / ACU / AEN / AEU		246-080-010-002Z	N-H	
07.95 →	AAF / ACU / AEN / AEU		246-082-008-014C	SWP-M-C	T1: 1

2.5 (85 kW | 2.5 Liter)

08.96 →	AET / APL / AVT		246-069-056-001Z	N	
08.96 →	AET / APL / AVT		246-080-010-002Z	N-H	

2.5 Syncro (85 kW | 2.5 Liter)

08.96 →	AET / APL / AVT		246-069-056-001Z	N	
08.96 →	AET / APL / AVT		246-080-010-002Z	N-H	
05.99 →	AET / APL / AVT		246-082-008-014C	SWP-M-C	T1: 1
05.99 →	AET / APL / AVT		246-086-001-002C	HLWP	T1: 3

1.9 D (45 kW | 1.9 Liter)

07.90 →	1X		246-069-056-001Z	N	
09.90 →	1X		246-080-010-002Z	N-H	

1.9 TD (50 kW | 1.9 Liter)

10.92 →	ABL		246-069-056-001Z	N	
10.92 →	ABL		246-080-010-002Z	N-H	
10.92 → 12.95	ABL		246-082-008-014C	SWP-M-C	T1: 1
10.92 → 12.95	ABL		246-083-002-014G	SWP-D-C	T1: 6
10.92 → 12.95	ABL		246-086-001-002C	HLWP	T1: 3

2.4 D (55 kW | 2.4 Liter)

08.97 →	AJA		246-069-056-001Z	N	
08.97 →	AJA		246-080-010-002Z	N-H	

2.4 D (57 kW | 2.4 Liter)

09.90 →	AAB		246-069-056-001Z	N	
09.90 →	AAB		246-080-010-002Z	N-H	

2.4 D Syncro (57 kW | 2.4 Liter)

10.92 →	AAB		246-069-056-001Z	N	
10.92 →	AAB		246-080-010-002Z	N-H	



			VDO		
Datum	Motorcode	Fahrgestell Nr.	Artikel Nr.	Artikelbez.	Information

VW**TRANSPORTER T4 Pritsche/Fahrgestell (70XD)****2.5 TDI (65 kW | 2.5 Liter)**

05.98 →	AJT / AYY		246-069-056-001Z	N	
05.98 →	AJT / AYY		246-080-010-002Z	N-H	

2.5 TDI (75 kW | 2.5 Liter)

09.95 →	ACV / AUF / AYC		246-069-056-001Z	N	
09.95 →	ACV / AUF / AYC		246-080-010-002Z	N-H	
01.96 → 03.98	ACV / AUF / AYC		246-082-008-014C	SWP-M-C	T1: 1
01.96 → 04.96	ACV / AUF / AYC		246-083-002-014G	SWP-D-C	T1: 6
01.96 → 05.97	ACV / AUF / AYC	→ W - 000 001	246-086-001-002C	HLWP	T1: 3
05.97 →	ACV / AUF / AYC	W - 000 001 →	246-086-001-007C	HLWP	T1: 3b; T3: X11-246-003-014

2.5 TDI Syncro (75 kW | 2.5 Liter)

05.98 →	ACV / AXL		246-082-008-014C	SWP-M-C	T1: 1
05.98 →	ACV / AXL		246-086-001-007C	HLWP	T1: 3b

TRANSPORTER T5 Bus (7HB, 7HJ)**2.0 (85 kW | 2.0 Liter)**

04.03 →	AXA	7J-3-000 001 →; → 7J-3-001 000	246-082-008-025G	SWP-M-C	T1: 3
04.03 →	AXA	7H-3-000 001 →; → 7H-3-001 000	246-083-002-022G	SWP-D-C	T1: 3
04.03 →	AXA	7J-3-000 001 →; → 7J-3-001 000	246-086-001-007C	HLWP	T1: 3b

3.2 V6 (170 kW | 3.2 Liter)

04.03 →	BDL	7J-3-000 001 →; → 7J-3-001 000	246-082-008-025G	SWP-M-C	T1: 3
04.03 →	BDL	7H-3-000 001 →; → 7H-3-001 000	246-083-002-022G	SWP-D-C	T1: 3
04.03 →	BDL	7J-3-000 001 →; → 7J-3-001 000	246-086-001-007C	HLWP	T1: 3b

3.2 V6 (173 kW | 3.2 Liter)

08.03 →	BKK	7J-3-000 001 →; → 7J-3-001 000	246-082-008-025G	SWP-M-C	T1: 3
08.03 →	BKK	7H-3-000 001 →; → 7H-3-001 000	246-083-002-022G	SWP-D-C	T1: 3
08.03 →	BKK	7J-3-000 001 →; → 7J-3-001 000	246-086-001-007C	HLWP	T1: 3b

1.9 TDI (63 kW | 1.9 Liter)

04.03 →	AXC	7J-3-000 001 →; → 7J-3-001 000	246-082-008-025G	SWP-M-C	T1: 3
04.03 →	AXC	7H-3-000 001 →; → 7H-3-001 000	246-083-002-022G	SWP-D-C	T1: 3
04.03 →	AXC	7J-3-000 001 →; → 7J-3-001 000	246-086-001-007C	HLWP	T1: 3b



			VDO		
Datum	Motorcode	Fahrgestell Nr.	Artikel Nr.	Artikelbez.	Information

VW**TRANSPORTER T5 Bus (7HB, 7HJ)****1.9 TDI (77 kW | 1.9 Liter)**

04.03 →	AXB	7J-3-000 001 →; → 7J-3-001 000	246-082-008-025G	SWP-M-C	T1: 3
04.03 →	AXB	7H-3-000 001 →; → 7H-3-001 000	246-083-002-022G	SWP-D-C	T1: 3
04.03 →	AXB	7J-3-000 001 →; → 7J-3-001 000	246-086-001-007C	HLWP	T1: 3b

2.5 TDI (96 kW | 2.5 Liter)

04.03 →	AXD	7J-3-000 001 →; → 7J-3-001 000	246-082-008-025G	SWP-M-C	T1: 3
04.03 →	AXD	7H-3-000 001 →; → 7H-3-001 000	246-083-002-022G	SWP-D-C	T1: 3
04.03 →	AXD	7J-3-000 001 →; → 7J-3-001 000	246-086-001-007C	HLWP	T1: 3b

2.5 TDI 4motion (96 kW | 2.5 Liter)

07.04 →	AXD	7J-3-000 001 →; → 7J-3-001 000	246-082-008-025G	SWP-M-C	T1: 3
07.04 →	AXD	7H-3-000 001 →; → 7H-3-001 000	246-083-002-022G	SWP-D-C	T1: 3
07.04 →	AXD	7J-3-000 001 →; → 7J-3-001 000	246-086-001-007C	HLWP	T1: 3b

2.5 TDI (128 kW | 2.5 Liter)

04.03 →	AXE	7J-3-000 001 →; → 7J-3-001 000	246-082-008-025G	SWP-M-C	T1: 3
04.03 →	AXE	7H-3-000 001 →; → 7H-3-001 000	246-083-002-022G	SWP-D-C	T1: 3
04.03 →	AXE	7J-3-000 001 →; → 7J-3-001 000	246-086-001-007C	HLWP	T1: 3b

2.5 TDI 4motion (128 kW | 2.5 Liter)

07.04 →	AXE	7J-3-000 001 →; → 7J-3-001 000	246-082-008-025G	SWP-M-C	T1: 3
07.04 →	AXE	7H-3-000 001 →; → 7H-3-001 000	246-083-002-022G	SWP-D-C	T1: 3
07.04 →	AXE	7J-3-000 001 →; → 7J-3-001 000	246-086-001-007C	HLWP	T1: 3b

TRANSPORTER T5 Kasten (7HA, 7HH)**2.0 (85 kW | 2.0 Liter)**

04.03 →	AXA	7J-3-000 001 →; → 7J-3-001 000	246-082-008-025G	SWP-M-C	T1: 3
04.03 →	AXA	7H-3-000 001 →; → 7H-3-001 000	246-083-002-022G	SWP-D-C	T1: 3
04.03 →	AXA	7J-3-000 001 →; → 7J-3-001 000	246-086-001-007C	HLWP	T1: 3b



			VDO		
Datum	Motorcode	Fahrgestell Nr.	Artikel Nr.	Artikelbez.	Information

VW**TRANSPORTER T5 Kasten (7HA, 7HH)****3.2 V6 (170 kW | 3.2 Liter)**

04.03 →	BDL	7J-3-000 001 →; → 7J-3-001 000	246-082-008-025G	SWP-M-C	T1: 3
04.03 →	BDL	7H-3-000 001 →; → 7H-3-001 000	246-083-002-022G	SWP-D-C	T1: 3
04.03 →	BDL	7J-3-000 001 →; → 7J-3-001 000	246-086-001-007C	HLWP	T1: 3b

3.2 V6 (173 kW | 3.2 Liter)

08.03 →	BKK	7J-3-000 001 →; → 7J-3-001 000	246-082-008-025G	SWP-M-C	T1: 3
08.03 →	BKK	7H-3-000 001 →; → 7H-3-001 000	246-083-002-022G	SWP-D-C	T1: 3
08.03 →	BKK	7J-3-000 001 →; → 7J-3-001 000	246-086-001-007C	HLWP	T1: 3b

1.9 TDI (63 kW | 1.9 Liter)

04.03 →	AXC	7J-3-000 001 →; → 7J-3-001 000	246-082-008-025G	SWP-M-C	T1: 3
04.03 →	AXC	7H-3-000 001 →; → 7H-3-001 000	246-083-002-022G	SWP-D-C	T1: 3
04.03 →	AXC	7J-3-000 001 →; → 7J-3-001 000	246-086-001-007C	HLWP	T1: 3b

1.9 TDI (77 kW | 1.9 Liter)

04.03 →	AXB	7J-3-000 001 →; → 7J-3-001 000	246-082-008-025G	SWP-M-C	T1: 3
04.03 →	AXB	7H-3-000 001 →; → 7H-3-001 000	246-083-002-022G	SWP-D-C	T1: 3
04.03 →	AXB	7J-3-000 001 →; → 7J-3-001 000	246-086-001-007C	HLWP	T1: 3b

2.5 TDI (96 kW | 2.5 Liter)

04.03 →	AXD	7J-3-000 001 →; → 7J-3-001 000	246-082-008-025G	SWP-M-C	T1: 3
04.03 →	AXD	7H-3-000 001 →; → 7H-3-001 000	246-083-002-022G	SWP-D-C	T1: 3
04.03 →	AXD	7J-3-000 001 →; → 7J-3-001 000	246-086-001-007C	HLWP	T1: 3b

2.5 TDI 4motion (96 kW | 2.5 Liter)

07.04 →	AXD	7J-3-000 001 →; → 7J-3-001 000	246-082-008-025G	SWP-M-C	T1: 3
07.04 →	AXD	7H-3-000 001 →; → 7H-3-001 000	246-083-002-022G	SWP-D-C	T1: 3
07.04 →	AXD	7J-3-000 001 →; → 7J-3-001 000	246-086-001-007C	HLWP	T1: 3b



			VDO		
Datum	Motorcode	Fahrgestell Nr.	Artikel Nr.	Artikelbez.	Information

VW**TRANSPORTER T5 Kasten (7HA, 7HH)****2.5 TDI (128 kW | 2.5 Liter)**

04.03 →	AXE	7J-3-000 001 →; → 7J-3-001 000	246-082-008-025G	SWP-M-C	T1: 3
04.03 →	AXE	7H-3-000 001 →; → 7H-3-001 000	246-083-002-022G	SWP-D-C	T1: 3
04.03 →	AXE	7J-3-000 001 →; → 7J-3-001 000	246-086-001-007C	HLWP	T1: 3b

2.5 TDI 4motion (128 kW | 2.5 Liter)

07.04 →	AXE	7J-3-000 001 →; → 7J-3-001 000	246-082-008-025G	SWP-M-C	T1: 3
07.04 →	AXE	7H-3-000 001 →; → 7H-3-001 000	246-083-002-022G	SWP-D-C	T1: 3
07.04 →	AXE	7J-3-000 001 →; → 7J-3-001 000	246-086-001-007C	HLWP	T1: 3b

TRANSPORTER T5 Pritsche/Fahrgestell (7JD, 7JE, 7JL)**2.0 (85 kW | 2.0 Liter)**

04.03 →	AXA	7J-3-000 001 →; → 7J-3-001 000	246-086-001-007C	HLWP	T1: 3b
---------	-----	-----------------------------------	------------------	------	--------

3.2 V6 (170 kW | 3.2 Liter)

04.03 →	BDL	7J-3-000 001 →; → 7J-3-001 000	246-086-001-007C	HLWP	T1: 3b
---------	-----	-----------------------------------	------------------	------	--------

3.2 V6 (173 kW | 3.2 Liter)

08.03 →	BKK	7J-3-000 001 →; → 7J-3-001 000	246-086-001-007C	HLWP	T1: 3b
---------	-----	-----------------------------------	------------------	------	--------

1.9 TDI (63 kW | 1.9 Liter)

04.03 →	AXC	7J-3-000 001 →; → 7J-3-001 000	246-086-001-007C	HLWP	T1: 3b
---------	-----	-----------------------------------	------------------	------	--------

1.9 TDI (77 kW | 1.9 Liter)

04.03 →	AXB	7J-3-000 001 →; → 7J-3-001 000	246-086-001-007C	HLWP	T1: 3b
---------	-----	-----------------------------------	------------------	------	--------

2.5 TDI (96 kW | 2.5 Liter)

04.03 →	AXD	7J-3-000 001 →; → 7J-3-001 000	246-086-001-007C	HLWP	T1: 3b
---------	-----	-----------------------------------	------------------	------	--------

2.5 TDI 4motion (96 kW | 2.5 Liter)

07.04 →	AXD	7J-3-000 001 →; → 7J-3-001 000	246-086-001-007C	HLWP	T1: 3b
---------	-----	-----------------------------------	------------------	------	--------

2.5 TDI (128 kW | 2.5 Liter)

04.03 →	AXE	7J-3-000 001 →; → 7J-3-001 000	246-086-001-007C	HLWP	T1: 3b
---------	-----	-----------------------------------	------------------	------	--------



MAN	418
MERCEDES-BENZ	424
SCANIA	430
VOLVO	436



Datum	Motorcode	Fahrgestell Nr.	Artikel Nr.	Artikelbez.	Information
-------	-----------	-----------------	-------------	-------------	-------------

MAN

F 2000

(170 kW 11.9 Liter Pritsche/Fahrgestell 4x2 19.0 t)					
09.96 →	E 2866 DF01		246-083-001-006C	SWP-D-C	T1: 1
(198 kW 9.9 Liter Pritsche/Fahrgestell 4x2 19.0 t)					
01.94 → 12.95	D 2865 LF22		246-083-001-006C	SWP-D-C	T1: 1
(198 kW 9.9 Liter Sattelzugmaschine 4x2 19.0 t)					
01.94 → 12.95	D 2865 LF22		246-083-001-006C	SWP-D-C	T1: 1
(198 kW 9.9 Liter Kipper 4x2 19.0 t)					
01.94 → 12.95	D 2865 LF22		246-083-001-006C	SWP-D-C	T1: 1
(213 kW 9.9 Liter Pritsche/Fahrgestell 4x2 19.0 t)					
01.94 →	D 2865 LF20 / D 2865 LF24		246-083-001-006C	SWP-D-C	T1: 1
(213 kW 9.9 Liter Sattelzugmaschine 4x2 19.0 t)					
01.94 →	D 2865 LF20 / D 2865 LF24		246-083-001-006C	SWP-D-C	T1: 1
(213 kW 9.9 Liter Kipper 4x2 19.0 t)					
01.94 →	D 2865 LF20 / D 2865 LF24		246-083-001-006C	SWP-D-C	T1: 1
(228 kW 11.9 Liter Pritsche/Fahrgestell 4x2 19.0 t)					
06.98 →	D 2866 LF34		246-083-001-006C	SWP-D-C	T1: 1
(228 kW 11.9 Liter Sattelzugmaschine 4x2 19.0 t)					
06.98 →	D 2866 LF34		246-083-001-006C	SWP-D-C	T1: 1
(228 kW 11.9 Liter Kipper 4x2 19.0 t)					
06.98 →	D 2866 LF34		246-083-001-006C	SWP-D-C	T1: 1
(235 kW 9.9 Liter Pritsche/Fahrgestell 4x2 19.0 t)					
01.94 → 12.95	D 2865 LF23		246-083-001-006C	SWP-D-C	T1: 1
(235 kW 9.9 Liter Sattelzugmaschine 4x2 19.0 t)					
01.94 → 12.95	D 2865 LF23		246-083-001-006C	SWP-D-C	T1: 1
(235 kW 9.9 Liter Kipper 4x2 19.0 t)					
01.94 → 12.95	D 2865 LF23		246-083-001-006C	SWP-D-C	T1: 1
(250 kW 9.9 Liter Pritsche/Fahrgestell 4x2 19.0 t)					
01.94 →	D 2865 LF21		246-083-001-006C	SWP-D-C	T1: 1
(250 kW 9.9 Liter Sattelzugmaschine 4x2 19.0 t)					
01.94 →	D 2865 LF21		246-083-001-006C	SWP-D-C	T1: 1
(250 kW 9.9 Liter Kipper 4x2 19.0 t)					
01.94 →	D 2865 LF21		246-083-001-006C	SWP-D-C	T1: 1
(265 kW 11.9 Liter Pritsche/Fahrgestell 4x2 19.0 t)					
06.98 →	D 2866 LF35		246-083-001-006C	SWP-D-C	T1: 1
(265 kW 11.9 Liter Sattelzugmaschine 4x2 19.0 t)					
06.98 →	D 2866 LF35		246-083-001-006C	SWP-D-C	T1: 1
(265 kW 11.9 Liter Kipper 4x2 19.0 t)					
06.98 →	D 2866 LF35		246-083-001-006C	SWP-D-C	T1: 1
(272 kW 11.9 Liter Pritsche/Fahrgestell 4x2 19.0 t)					
01.94 → 12.95	D 2866 LF21		246-083-001-006C	SWP-D-C	T1: 1



Datum	Motorcode	Fahrgestell Nr.	Artikel Nr.	Artikelbez.	Information
-------	-----------	-----------------	-------------	-------------	-------------

MAN

F 2000

(272 kW 11.9 Liter Sattelzugmaschine 4x2 19.0 t)					
01.94 → 12.95	D 2866 LF21		246-083-001-006C	SWP-D-C	T1: 1
(272 kW 11.9 Liter Kipper 4x2 19.0 t)					
01.94 → 12.95	D 2866 LF21		246-083-001-006C	SWP-D-C	T1: 1
(294 kW 11.9 Liter Pritsche/Fahrgestell 4x2 19.0 t)					
01.94 →	D 2866 LF20		246-083-001-006C	SWP-D-C	T1: 1
(294 kW 11.9 Liter Sattelzugmaschine 4x2 19.0 t)					
01.94 →	D 2866 LF20		246-083-001-006C	SWP-D-C	T1: 1
(294 kW 11.9 Liter Kipper 4x2 19.0 t)					
01.94 →	D 2866 LF20		246-083-001-006C	SWP-D-C	T1: 1
(301 kW 11.9 Liter Pritsche/Fahrgestell 4x2 19.0 t)					
06.98 →	D 2866 LF31		246-083-001-006C	SWP-D-C	T1: 1
(301 kW 11.9 Liter Sattelzugmaschine 4x2 19.0 t)					
06.98 →	D 2866 LF31		246-083-001-006C	SWP-D-C	T1: 1
(301 kW 11.9 Liter Kipper 4x2 19.0 t)					
06.98 →	D 2866 LF31		246-083-001-006C	SWP-D-C	T1: 1
(309 kW 11.9 Liter Pritsche/Fahrgestell 4x2 19.0 t)					
01.94 → 12.95	D 2866 LF22		246-083-001-006C	SWP-D-C	T1: 1
(309 kW 11.9 Liter Sattelzugmaschine 4x2 19.0 t)					
01.94 → 12.95	D 2866 LF22		246-083-001-006C	SWP-D-C	T1: 1
(309 kW 11.9 Liter Kipper 4x2 19.0 t)					
01.94 → 12.95	D 2866 LF22		246-083-001-006C	SWP-D-C	T1: 1
(338 kW 12.8 Liter Pritsche/Fahrgestell 4x2 19.0 t)					
01.94 →	D 2876 LF 02		246-083-001-006C	SWP-D-C	T1: 1
(338 kW 12.8 Liter Sattelzugmaschine 4x2 19.0 t)					
01.94 →	D 2876 LF 02		246-083-001-006C	SWP-D-C	T1: 1
(338 kW 12.8 Liter Kipper 4x2 19.0 t)					
01.94 →	D 2876 LF 02		246-083-001-006C	SWP-D-C	T1: 1
(338 kW 12.8 Liter Pritsche/Fahrgestell 4x2 19.0 t)					
06.98 →	D 2876 LF 06		246-083-001-006C	SWP-D-C	T1: 1
(338 kW 12.8 Liter Sattelzugmaschine 4x2 19.0 t)					
06.98 →	D 2876 LF 06		246-083-001-006C	SWP-D-C	T1: 1
(338 kW 12.8 Liter Kipper 4x2 19.0 t)					
06.98 →	D 2876 LF 06		246-083-001-006C	SWP-D-C	T1: 1
(441 kW 18.2 Liter Sattelzugmaschine 4x2 19.0 t)					
04.96 →	D 2840 LF20		246-083-001-006C	SWP-D-C	T1: 1



Datum	Motorcode	Fahrgestell Nr.	Artikel Nr.	Artikelbez.	Information
-------	-----------	-----------------	-------------	-------------	-------------

MAN

G

(66 kW → 66 kW | 3.7 Liter | Pritsche/Fahrgestell | 4x2 | 6.0 t)

10.79 → 09.87	D 0224 MF		246-075-010-001C	SWP-M-G	T1: 1; T2: A
10.79 → 09.87	D 0224 MF		246-082-008-012C	SWP-M-C	T1: 1

(66 kW | 3.7 Liter | Kipper | 4x2 | 6.0 t)

10.79 → 09.87	D 0224 MF		246-075-010-001C	SWP-M-G	T1: 1; T2: A
10.79 → 09.87	D 0224 MF		246-082-008-012C	SWP-M-C	T1: 1

L 2000

(75 kW | 4.5 Liter | Pritsche/Fahrgestell | 4x2 | 8.0 t)

10.93 → 06.96	D 0824 FL 01		246-083-001-006C	SWP-D-C	T1: 1
---------------	--------------	--	------------------	---------	-------

(75 kW | 4.5 Liter | Kipper | 4x2 | 8.0 t)

10.93 → 06.96	D 0824 FL 01		246-083-001-006C	SWP-D-C	T1: 1
---------------	--------------	--	------------------	---------	-------

(81 kW | 4.5 Liter | Pritsche/Fahrgestell | 4x2 | 8.0 t)

08.95 →	D 0824 LFL 04		246-083-001-006C	SWP-D-C	T1: 1
---------	---------------	--	------------------	---------	-------

(83 kW | 4.5 Liter | Pritsche/Fahrgestell | 4x2 | 7.49 t)

09.00 →	D 0824 LFL 08		246-083-001-006C	SWP-D-C	T1: 1
---------	---------------	--	------------------	---------	-------

(81 kW | 4.5 Liter | Kipper | 4x2 | 8.0 t)

08.95 →	D 0824 LFL 04		246-083-001-006C	SWP-D-C	T1: 1
---------	---------------	--	------------------	---------	-------

(103 kW | 4.5 Liter | Pritsche/Fahrgestell | 4x2 | 7.49 t)

09.00 →	D 0834 LFL 02		246-083-001-006C	SWP-D-C	T1: 1
---------	---------------	--	------------------	---------	-------

(103 kW | 4.5 Liter | Kipper | 4x2 | 7.49 t)

09.00 →	D 0834 LFL 02		246-083-001-006C	SWP-D-C	T1: 1
---------	---------------	--	------------------	---------	-------

(114 kW → 118 kW | 4.5 Liter | Bus | 4x2 | 8.0 t)

02.95 →	D 0824 LFO		246-083-001-006C	SWP-D-C	T1: 1
---------	------------	--	------------------	---------	-------

(114 kW | 4.5 Liter | Pritsche/Fahrgestell | 4x2 | 8.0 t)

10.93 → 07.97	D 0824 LFL 01 / D 0824 LFL 05		246-083-001-006C	SWP-D-C	T1: 1
---------------	----------------------------------	--	------------------	---------	-------

(114 kW | 4.5 Liter | Sattelzugmaschine | 4x2 | 8.0 t)

10.93 → 06.96	D 0824 LFL 01 / D 0824 LFL 05		246-083-001-006C	SWP-D-C	T1: 1
---------------	----------------------------------	--	------------------	---------	-------

(114 kW | 4.5 Liter | Kipper | 4x2 | 8.0 t)

10.93 → 07.97	D 0824 LFL 01 / D 0824 LFL 05		246-083-001-006C	SWP-D-C	T1: 1
---------------	----------------------------------	--	------------------	---------	-------

(104 kW | 4.5 Liter | Pritsche/Fahrgestell | 4x2 | 8.0 t)

08.95 →	D 0824 LFL 07		246-083-001-006C	SWP-D-C	T1: 1
---------	---------------	--	------------------	---------	-------

(114 kW → 118 kW | 4.5 Liter | Pritsche/Fahrgestell | 4x2 | 8.0 t)

05.94 →	D 0824 LFL 02 / D 0824 LFL 06 / D 0824 LFL 09		246-083-001-006C	SWP-D-C	T1: 1
---------	-----------------------------------------------------	--	------------------	---------	-------

(114 kW | 4.5 Liter | Pritsche/Fahrgestell | 4x2 | 7.49 t)

09.00 →	D 0824 LFL 09		246-083-001-006C	SWP-D-C	T1: 1
---------	---------------	--	------------------	---------	-------



Datum	Motorcode	Fahrgestell Nr.	Artikel Nr.	Artikelbez.	Information
MAN					
L 2000					
(114 kW → 118 kW 4.5 Liter Sattelzugmaschine 4x2 8.0 t)					
05.94 →	D 0824 LFL 02 / D 0824 LFL 06 / D 0824 LFL 09		246-083-001-006C	SWP-D-C	T1: 1
(114 kW → 118 kW 4.5 Liter Kipper 4x2 8.0 t)					
05.94 →	D 0824 LFL 02 / D 0824 LFL 06 / D 0824 LFL 09		246-083-001-006C	SWP-D-C	T1: 1
(132 kW 4.5 Liter Pritsche/Fahrgestell 4x2 7.49 t)					
09.00 →	D 0834 LFL 03		246-083-001-006C	SWP-D-C	T1: 1
(162 kW 6.8 Liter Bus 4x2 8.0 t)					
04.95 →	D 0826 LFL03		246-083-001-006C	SWP-D-C	T1: 1
(162 kW → 169 kW 6.8 Liter Pritsche/Fahrgestell 4x2 8.0 t)					
10.93 → 06.96	D 0826 LFL02 / D 0826 LFL06		246-083-001-006C	SWP-D-C	T1: 1
(162 kW → 169 kW 6.8 Liter Sattelzugmaschine 4x2 8.0 t)					
10.93 → 06.96	D 0826 LFL02 / D 0826 LFL06		246-083-001-006C	SWP-D-C	T1: 1
(162 kW → 169 kW 6.8 Liter Kipper 4x2 8.0 t)					
10.93 → 06.96	D 0826 LFL02 / D 0826 LFL06		246-083-001-006C	SWP-D-C	T1: 1
(162 kW 6.8 Liter Pritsche/Fahrgestell 4x2 8.0 t)					
05.94 →	D 0826 LFL03		246-083-001-006C	SWP-D-C	T1: 1
(162 kW 6.8 Liter Sattelzugmaschine 4x2 8.0 t)					
05.94 →	D 0826 LFL03		246-083-001-006C	SWP-D-C	T1: 1
(162 kW 6.8 Liter Kipper 4x2 8.0 t)					
05.94 →	D 0826 LFL03		246-083-001-006C	SWP-D-C	T1: 1
(162 kW 6.8 Liter Pritsche/Fahrgestell 4x2 7.49 t)					
09.00 →	D 0826 LFL10 / D 0836 LFL 02		246-083-001-006C	SWP-D-C	T1: 1
(114 kW 4.5 Liter Pritsche/Fahrgestell 4x2 9.0 t)					
10.93 → 06.96	D 0824 LFL 01 / D 0824 LFL 05		246-083-001-006C	SWP-D-C	T1: 1
(114 kW 4.5 Liter Sattelzugmaschine 4x2 9.0 t)					
10.93 → 12.95	D 0824 LFL 01 / D 0824 LFL 05		246-083-001-006C	SWP-D-C	T1: 1
(114 kW 4.5 Liter Kipper 4x2 9.0 t)					
10.93 → 06.96	D 0824 LFL 01 / D 0824 LFL 05		246-083-001-006C	SWP-D-C	T1: 1
(104 kW 4.5 Liter Pritsche/Fahrgestell 4x2 9.0 t)					
08.95 → 03.97	D 0824 LFL 07		246-083-001-006C	SWP-D-C	T1: 1
(114 kW → 118 kW 4.5 Liter Pritsche/Fahrgestell 4x2 9.0 t)					
05.94 →	D 0824 LFL 02 / D 0824 LFL 06 / D 0824 LFL 09		246-083-001-006C	SWP-D-C	T1: 1



Datum	Motorcode	Fahrgestell Nr.	Artikel Nr.	Artikelbez.	Information
-------	-----------	-----------------	-------------	-------------	-------------

MAN

L 2000

(114 kW → 118 kW 4.5 Liter Sattelzugmaschine 4x2 9.0 t)					
05.94 →	D 0824 LFL 02 / D 0824 LFL 06 / D 0824 LFL 09		246-083-001-006C	SWP-D-C	T1: 1
(104 kW 4.5 Liter Kipper 4x2 9.0 t)					
08.95 → 03.97	D 0824 LFL 07		246-083-001-006C	SWP-D-C	T1: 1
(114 kW → 118 kW 4.5 Liter Kipper 4x2 9.0 t)					
05.94 →	D 0824 LFL 02 / D 0824 LFL 06 / D 0824 LFL 09		246-083-001-006C	SWP-D-C	T1: 1
(132 kW 4.5 Liter Pritsche/Fahrgestell 4x2 8.99 t)					
09.00 →	D 0834 LFL 03		246-083-001-006C	SWP-D-C	T1: 1
(162 kW 6.8 Liter Pritsche/Fahrgestell 4x2 9.0 t)					
10.93 → 06.96	D 0826 LFL02 / D 0826 LFL06		246-083-001-006C	SWP-D-C	T1: 1
(162 kW 6.8 Liter Sattelzugmaschine 4x2 9.0 t)					
10.93 → 06.96	D 0826 LFL02 / D 0826 LFL06		246-083-001-006C	SWP-D-C	T1: 1
(162 kW 6.8 Liter Kipper 4x2 9.0 t)					
10.93 → 06.96	D 0826 LFL02 / D 0826 LFL06		246-083-001-006C	SWP-D-C	T1: 1
(162 kW 6.8 Liter Pritsche/Fahrgestell 4x2 9.0 t)					
05.94 →	D 0826 LFL03		246-083-001-006C	SWP-D-C	T1: 1
(162 kW 6.8 Liter Sattelzugmaschine 4x2 9.0 t)					
05.94 →	D 0826 LFL03		246-083-001-006C	SWP-D-C	T1: 1
(162 kW 6.8 Liter Kipper 4x2 9.0 t)					
05.94 →	D 0826 LFL03		246-083-001-006C	SWP-D-C	T1: 1
(114 kW → 118 kW 4.5 Liter Bus 4x2 10.0 t)					
02.95 → 01.96	D 0824 LFO		246-083-001-006C	SWP-D-C	T1: 1

M 90

(110 kW → 114 kW 6.8 Liter Pritsche/Fahrgestell 4x2 12.0 t)					
12.88 → 05.94	D 0826 F01 / D 0826 F02		246-075-010-001C	SWP-M-G	T1: 1; T2: A
(110 kW → 114 kW 6.8 Liter Sattelzugmaschine 4x2 12.0 t)					
12.88 → 05.94	D 0826 F01 / D 0826 F02		246-075-010-001C	SWP-M-G	T1: 1; T2: A
(110 kW → 114 kW 6.8 Liter Kipper 4x2 12.0 t)					
12.88 → 05.94	D 0826 F01 / D 0826 F02		246-075-010-001C	SWP-M-G	T1: 1; T2: A
(140 kW 6.8 Liter Pritsche/Fahrgestell 4x2 12.0 t)					
07.90 → 06.96	D 0826 LF01 / D 0826 LF05 / D 0826 LF07		246-075-010-001C	SWP-M-G	T1: 1; T2: A
(140 kW 6.8 Liter Sattelzugmaschine 4x2 12.0 t)					
07.90 → 06.96	D 0826 LF01 / D 0826 LF05 / D 0826 LF07		246-075-010-001C	SWP-M-G	T1: 1; T2: A



Datum	Motorcode	Fahrgestell Nr.	Artikel Nr.	Artikelbez.	Information
-------	-----------	-----------------	-------------	-------------	-------------

MAN**M 90**

(140 kW 6.8 Liter Pritsche/Fahrgestell 4x4 12.0 t)					
10.92 → 06.96	D 0826 LF05 / D 0826 LF07		246-075-010-001C	SWP-M-G	T1: 1; T2: A
(140 kW 6.8 Liter Kipper 4x2 12.0 t)					
07.90 → 06.96	D 0826 LF01 / D 0826 LF05 / D 0826 LF07		246-075-010-001C	SWP-M-G	T1: 1; T2: A
(140 kW 6.8 Liter Kipper 4x4 12.0 t)					
10.92 → 06.96	D 0826 LF05 / D 0826 LF07		246-075-010-001C	SWP-M-G	T1: 1; T2: A
(162 kW 6.8 Liter Pritsche/Fahrgestell 4x2 12.0 t)					
05.94 → 06.96	D 0826 LF11		246-075-010-001C	SWP-M-G	T1: 1; T2: A
(162 kW 6.8 Liter Pritsche/Fahrgestell 4x4 12.0 t)					
05.94 → 06.96	D 0826 LF11		246-075-010-001C	SWP-M-G	T1: 1; T2: A
(162 kW 6.8 Liter Sattelzugmaschine 4x2 12.0 t)					
05.94 → 06.96	D 0826 LF11		246-075-010-001C	SWP-M-G	T1: 1; T2: A
(162 kW 6.8 Liter Kipper 4x2 12.0 t)					
05.94 → 06.96	D 0826 LF11		246-075-010-001C	SWP-M-G	T1: 1; T2: A
(162 kW 6.8 Liter Kipper 4x4 12.0 t)					
05.94 → 06.96	D 0826 LF11		246-075-010-001C	SWP-M-G	T1: 1; T2: A
(169 kW 6.8 Liter Pritsche/Fahrgestell 4x2 12.0 t)					
08.88 → 06.96	D 0826 LF02 / D 0826 LF06 / D 0826 LF08		246-075-010-001C	SWP-M-G	T1: 1; T2: A
(169 kW 6.8 Liter Pritsche/Fahrgestell 4x4 12.0 t)					
05.90 → 06.96	D 0826 LF02 / D 0826 LF06 / D 0826 LF08		246-075-010-001C	SWP-M-G	T1: 1; T2: A
(169 kW 6.8 Liter Sattelzugmaschine 4x2 12.0 t)					
08.88 → 06.96	D 0826 LF02 / D 0826 LF06 / D 0826 LF08		246-075-010-001C	SWP-M-G	T1: 1; T2: A
(169 kW 6.8 Liter Kipper 4x2 12.0 t)					
08.88 → 06.96	D 0826 LF02 / D 0826 LF06 / D 0826 LF08		246-075-010-001C	SWP-M-G	T1: 1; T2: A
(169 kW 6.8 Liter Kipper 4x4 12.0 t)					
05.90 → 06.96	D 0826 LF02 / D 0826 LF06 / D 0826 LF08		246-075-010-001C	SWP-M-G	T1: 1; T2: A
(191 kW 6.8 Liter Pritsche/Fahrgestell 4x2 12.0 t)					
08.95 → 06.96	D 0826 LF13		246-075-010-001C	SWP-M-G	T1: 1; T2: A
(191 kW 6.8 Liter Sattelzugmaschine 4x2 12.0 t)					
08.95 → 06.96	D 0826 LF13		246-075-010-001C	SWP-M-G	T1: 1; T2: A
(191 kW 6.8 Liter Kipper 4x2 12.0 t)					
08.95 → 06.96	D 0826 LF13		246-075-010-001C	SWP-M-G	T1: 1; T2: A
(198 kW 6.8 Liter Pritsche/Fahrgestell 4x2 12.0 t)					
10.92 → 06.96	D 0826 LF04		246-075-010-001C	SWP-M-G	T1: 1; T2: A
(198 kW 9.9 Liter Pritsche/Fahrgestell 4x2 12.0 t)					
09.91 → 10.92	D 2865 LF02		246-075-010-001C	SWP-M-G	T1: 1; T2: A
(198 kW 6.8 Liter Pritsche/Fahrgestell 4x4 12.0 t)					
10.93 → 04.95	D 0826 LF04		246-075-010-001C	SWP-M-G	T1: 1; T2: A



Datum	Motorcode	Fahrgestell Nr.	Artikel Nr.	Artikelbez.	Information
-------	-----------	-----------------	-------------	-------------	-------------

MAN

M 90

(198 kW 6.8 Liter Sattelzugmaschine 4x2 12.0 t)					
10.92 → 06.96	D 0826 LF04		246-075-010-001C	SWP-M-G	T1: 1; T2: A
(198 kW 9.9 Liter Sattelzugmaschine 4x2 12.0 t)					
09.91 → 10.92	D 2865 LF02		246-075-010-001C	SWP-M-G	T1: 1; T2: A
(198 kW 6.8 Liter Kipper 4x2 12.0 t)					
10.92 → 06.96	D 0826 LF04		246-075-010-001C	SWP-M-G	T1: 1; T2: A
(198 kW 9.9 Liter Kipper 4x2 12.0 t)					
09.91 → 10.92	D 2865 LF02		246-075-010-001C	SWP-M-G	T1: 1; T2: A
(198 kW 6.8 Liter Kipper 4x4 12.0 t)					
10.93 → 04.95	D 0826 LF04		246-075-010-001C	SWP-M-G	T1: 1; T2: A

M 2000 L

(114 kW 4.5 Liter Pritsche/Fahrgestell 4x2 12.0 t)					
08.95 →	D 0824 LFL 06 / D 0824 LFL 09		246-075-010-001C	SWP-M-G	T1: 1; T2: A
(114 kW 4.5 Liter Kipper 4x2 12.0 t)					
08.95 →	D 0824 LFL 06 / D 0824 LFL 09		246-075-010-001C	SWP-M-G	T1: 1; T2: A
(162 kW 6.8 Liter Pritsche/Fahrgestell 4x2 12.0 t)					
08.95 →	D 0826 LFL03 / D 0826 LFL10		246-075-010-001C	SWP-M-G	T1: 1; T2: A
(162 kW 6.8 Liter Kipper 4x2 12.0 t)					
08.95 →	D 0826 LFL03 / D 0826 LFL10		246-075-010-001C	SWP-M-G	T1: 1; T2: A

MERCEDES-BENZ

LK/LN2

(63 kW → 66 kW 3.9 Liter Pritsche/Fahrgestell 4x2 7.0 t)					
03.84 → 12.98	OM 364.907 / OM 364.918		246-082-008-012C	SWP-M-C	T1: 1
(63 kW → 66 kW 3.9 Liter Kipper 4x2 7.0 t)					
03.84 → 10.90	OM 364.907 / OM 364.918		246-082-008-012C	SWP-M-C	T1: 1
(77 kW 3.9 Liter Pritsche/Fahrgestell 4x2 7.0 t)					
03.94 → 12.98	OM 354.900		246-082-008-012C	SWP-M-C	T1: 1
(90 kW 4.2 Liter Pritsche/Fahrgestell 4x2 7.0 t)					
03.96 → 12.98	OM 904.905		246-082-008-012C	SWP-M-C	T1: 1
(63 kW → 66 kW 3.9 Liter Pritsche/Fahrgestell 4x2 8.0 t)					
03.84 → 12.98	OM 364.907 / OM 364.918		246-082-008-012C	SWP-M-C	T1: 1
(63 kW → 66 kW 3.9 Liter Kipper 4x2 8.0 t)					
03.84 → 12.98	OM 364.907 / OM 364.918		246-082-008-012C	SWP-M-C	T1: 1
(77 kW 3.9 Liter Pritsche/Fahrgestell 4x2 8.0 t)					
03.94 → 12.98	OM 354.900		246-082-008-012C	SWP-M-C	T1: 1



Datum	Motorcode	Fahrgestell Nr.	Artikel Nr.	Artikelbez.	Information
-------	-----------	-----------------	-------------	-------------	-------------

MERCEDES-BENZ

LK/LN2

(77 kW 3.9 Liter Kipper 4x2 8.0 t)					
03.94 → 12.98	OM 354.900		246-082-008-012C	SWP-M-C	T1: 1
(90 kW 4.2 Liter Pritsche/Fahrgestell 4x2 8.0 t)					
03.96 → 12.98	OM 904.905		246-082-008-012C	SWP-M-C	T1: 1
(90 kW 4.2 Liter Kipper 4x2 8.0 t)					
03.96 → 12.98	OM 904.905		246-082-008-012C	SWP-M-C	T1: 1
(103 kW 3.9 Liter Pritsche/Fahrgestell 4x2 8.0 t)					
01.84 → 12.98	OM 354.920		246-082-008-012C	SWP-M-C	T1: 1
(103 kW 3.9 Liter Kipper 4x2 8.0 t)					
03.94 → 12.98	OM 354.920		246-082-008-012C	SWP-M-C	T1: 1
(103 kW 3.9 Liter Sattelzugmaschine 4x2 8.0 t)					
03.94 → 12.98	OM 354.920		246-082-008-012C	SWP-M-C	T1: 1
(95 kW → 100 kW 5.9 Liter Pritsche/Fahrgestell 4x2 8.0 t)					
01.84 → 12.98	OM 356.901 / OM 356.902 / OM 366.905 / OM 366.906 / OM 366.907 / OM 366.910		246-082-008-012C	SWP-M-C	T1: 1
(95 kW → 100 kW 5.9 Liter Kipper 4x2 8.0 t)					
03.84 → 12.98	OM 356.901 / OM 356.902 / OM 366.905 / OM 366.906 / OM 366.907 / OM 366.910		246-082-008-012C	SWP-M-C	T1: 1
(95 kW → 100 kW 5.9 Liter Sattelzugmaschine 4x2 8.0 t)					
03.84 → 12.98	OM 356.901 / OM 356.902 / OM 366.905 / OM 366.906 / OM 366.907 / OM 366.910		246-082-008-012C	SWP-M-C	T1: 1
(100 kW 4.2 Liter Pritsche/Fahrgestell 4x2 8.0 t)					
01.84 → 12.98	OM 904.906		246-082-008-012C	SWP-M-C	T1: 1
(100 kW 4.2 Liter Kipper 4x2 8.0 t)					
03.96 → 12.98	OM 904.906		246-082-008-012C	SWP-M-C	T1: 1
(100 kW 4.2 Liter Sattelzugmaschine 4x2 8.0 t)					
03.96 → 12.98	OM 904.906		246-082-008-012C	SWP-M-C	T1: 1
(103 kW 3.9 Liter Kommunalfahrzeug 4x2 8.0 t)					
03.94 → 12.98	OM 354.922		246-082-008-012C	SWP-M-C	T1: 1
(95 kW → 100 kW 5.9 Liter Kommunalfahrzeug 4x2 8.0 t)					
05.86 → 12.98	OM 356.905 / OM 356.911 / OM 366.905		246-082-008-012C	SWP-M-C	T1: 1
(100 kW 4.2 Liter Kommunalfahrzeug 4x2 8.0 t)					
03.96 → 12.98	OM 904.906		246-082-008-012C	SWP-M-C	T1: 1
(103 kW 3.9 Liter Bus 4x2 8.0 t)					
01.84 → 12.98	OM 354.921		246-082-008-012C	SWP-M-C	T1: 1
(95 kW → 100 kW 5.9 Liter Bus 4x2 8.0 t)					
01.84 → 12.98	OM 356.906 / OM 366.932		246-082-008-012C	SWP-M-C	T1: 1
(100 kW 4.2 Liter Bus 4x2 8.0 t)					
03.96 → 12.98	OM 904.906		246-082-008-012C	SWP-M-C	T1: 1



Datum	Motorcode	Fahrgestell Nr.	Artikel Nr.	Artikelbez.	Information
-------	-----------	-----------------	-------------	-------------	-------------

MERCEDES-BENZ

LP

(63 kW 3.7 Liter Pritsche/Fahrgestell 4x2 7.0 t)					
09.63 → 12.84	OM 314.910 / OM 314.944		246-082-008-012C	SWP-M-C	T1: 1
(63 kW 3.7 Liter Sattelzugmaschine 4x2 7.0 t)					
09.63 → 12.84	OM 314.910 / OM 314.944		246-082-008-012C	SWP-M-C	T1: 1
(63 kW 3.7 Liter Kommunalfahrzeug 4x2 7.0 t)					
11.77 → 12.84	OM 314.910 / OM 314.944		246-082-008-012C	SWP-M-C	T1: 1
(63 kW 3.7 Liter Bus 4x2 7.0 t)					
11.77 → 12.84	OM 314.910 / OM 314.944		246-082-008-012C	SWP-M-C	T1: 1
(63 kW 3.7 Liter Kipper 4x2 7.0 t)					
11.77 → 12.84	OM 314.910 / OM 314.944		246-082-008-012C	SWP-M-C	T1: 1
(63 kW 3.7 Liter Pritsche/Fahrgestell 4x2 8.0 t)					
09.63 → 12.84	OM 314.910 / OM 314.944		246-082-008-012C	SWP-M-C	T1: 1
(63 kW 3.7 Liter Kipper 4x2 8.0 t)					
11.77 → 12.84	OM 314.910 / OM 314.944		246-082-008-012C	SWP-M-C	T1: 1
(81 kW 5.6 Liter Pritsche/Fahrgestell 4x2 8.0 t)					
10.69 → 02.73	OM 352		246-082-008-012C	SWP-M-C	T1: 1
(81 kW 5.6 Liter Sattelzugmaschine 4x2 8.0 t)					
10.69 → 02.73	OM 352		246-082-008-012C	SWP-M-C	T1: 1

MK

(160 kW → 165 kW 10.9 Liter Pritsche/Fahrgestell 4x2 12.0 t)					
07.89 → 08.94	OM 441.905 / OM 441.913 / OM 441.923 / OM 441.925		246-082-008-012C	SWP-M-C	T1: 1
(160 kW → 165 kW 10.9 Liter Sattelzugmaschine 4x2 12.0 t)					
07.89 → 08.94	OM 441.905 / OM 441.913 / OM 441.923 / OM 441.925		246-082-008-012C	SWP-M-C	T1: 1
(160 kW → 165 kW 10.9 Liter Kommunalfahrzeug 4x2 12.0 t)					
07.89 → 08.94	OM 441.905 / OM 441.913 / OM 441.923 / OM 441.925		246-082-008-012C	SWP-M-C	T1: 1
(160 kW → 165 kW 10.9 Liter Pritsche/Fahrgestell 4x4 12.0 t)					
09.89 → 07.94	OM 441.914 / OM 441.926		246-082-008-012C	SWP-M-C	T1: 1
(160 kW → 165 kW 10.9 Liter Kommunalfahrzeug 4x4 12.0 t)					
09.89 → 09.93	OM 441.915 / OM 441.917 / OM 441.923		246-082-008-012C	SWP-M-C	T1: 1
(170 kW → 177 kW 5.9 Liter Kommunalfahrzeug 4x4 12.0 t)					
02.93 → 09.96	OM 356.999 / OM 357.946 / OM 366.999		246-082-008-012C	SWP-M-C	T1: 1
(180 kW 9.5 Liter Kommunalfahrzeug 4x4 12.0 t)					
02.93 → 09.96	OM 401.984		246-082-008-012C	SWP-M-C	T1: 1
(180 kW → 200 kW 9.5 Liter Kommunalfahrzeug 4x4 12.0 t)					
02.93 → 09.96	OM 401.973 / OM 401.978 / OM 401.984 / OM 401.989		246-082-008-012C	SWP-M-C	T1: 1
(250 kW 10.9 Liter Kommunalfahrzeug 4x4 12.0 t)					
02.93 → 09.96	OM 441.989		246-082-008-012C	SWP-M-C	T1: 1



Datum	Motorcode	Fahrgestell Nr.	Artikel Nr.	Artikelbez.	Information
-------	-----------	-----------------	-------------	-------------	-------------

MERCEDES-BENZ

MK

(195 kW → 218 kW 15.0 Liter Kommalfahrzeug 4x4 12.0 t)					
02.90 → 09.93	OM 442.907 / OM 442.914 / OM 442.920 / OM 442.926 / OM 442.932 / OM 442.933		246-082-008-012C	SWP-M-C	T1: 1
(200 kW 9.5 Liter Pritsche/Fahrgestell 4x4 12.0 t)					
01.92 → 07.92	OM 401.973 / OM 401.989		246-082-008-012C	SWP-M-C	T1: 1
(250 kW 10.9 Liter Kommalfahrzeug 4x4 12.0 t)					
01.92 → 09.96	OM 441.989 / OM 441.993 / OM 445.923		246-082-008-012C	SWP-M-C	T1: 1

NG

(96 kW 5.7 Liter Pritsche/Fahrgestell 4x2 10.0 t)					
02.76 → 12.84	OM 353.942 / OM 353.943		246-075-024-002C	SWP-M-G	T1: 1; T2: C
(96 kW 5.7 Liter Pritsche/Fahrgestell 4x4 10.0 t)					
02.76 → 12.86	OM 353.942 / OM 353.943		246-075-024-002C	SWP-M-G	T1: 1; T2: C
(96 kW 5.7 Liter Kommalfahrzeug 4x2 10.0 t)					
02.76 → 12.84	OM 353.943 / OM 353.945 / OM 353.946		246-075-024-002C	SWP-M-G	T1: 1; T2: C
(96 kW 5.7 Liter Sattelzugmaschine 4x2 10.0 t)					
02.76 → 12.84	OM 353.942 / OM 353.943 / OM 353.946		246-075-024-002C	SWP-M-G	T1: 1; T2: C
(96 kW 5.7 Liter Kipper 4x2 10.0 t)					
02.76 → 12.84	OM 353.942 / OM 353.943 / OM 353.945 / OM 353.946		246-075-024-002C	SWP-M-G	T1: 1; T2: C
(96 kW 5.7 Liter Kipper 4x4 10.0 t)					
02.76 → 12.84	OM 353.942 / OM 353.943 / OM 353.945 / OM 353.946		246-075-024-002C	SWP-M-G	T1: 1; T2: C
(206 kW 14.6 Liter Sattelzugmaschine 6x2/4 20.0 t)					
01.80 → 06.89	OM 422.905 / OM 422.906 / OM 422.910 / OM 422.911		246-075-024-002C	SWP-M-G	T1: 1; T2: C

T2/L

(44 kW 2.1 Liter Kasten/Kombi 4x2 4.0 t)					
01.68 → 12.74	OM 615.910		246-075-024-002C	SWP-M-G	T1: 1; T2: C
(44 kW 2.1 Liter Pritsche/Fahrgestell 4x2 4.0 t)					
01.68 → 12.74	OM 615.910		246-075-024-002C	SWP-M-G	T1: 1; T2: C

T2/LN1

(63 kW → 66 kW 3.9 Liter Kasten/Kombi 4x2 6.0 t)					
04.86 → 12.94	OM 364.906 / OM 364.919		246-082-008-012C	SWP-M-C	T1: 1
(63 kW → 66 kW 3.9 Liter Pritsche/Fahrgestell 4x2 6.0 t)					
04.86 → 12.94	OM 364.906 / OM 364.919		246-082-008-012C	SWP-M-C	T1: 1



Datum	Motorcode	Fahrgestell Nr.	Artikel Nr.	Artikelbez.	Information
-------	-----------	-----------------	-------------	-------------	-------------

MERCEDES-BENZ

T2/LN1

(63 kW → 66 kW 3.9 Liter Kipper 4x2 6.0 t)					
04.86 → 12.94	OM 364.906 / OM 364.919		246-082-008-012C	SWP-M-C	T1: 1
(77 kW 3.9 Liter Kasten/Kombi 4x2 6.0 t)					
06.94 → 12.94	OM 354.902		246-082-008-012C	SWP-M-C	T1: 1
(77 kW 3.9 Liter Pritsche/Fahrgestell 4x2 6.0 t)					
06.94 → 12.94	OM 354.902		246-082-008-012C	SWP-M-C	T1: 1
(77 kW 3.9 Liter Kasten/Kombi 4x2 5.6 t)					
06.94 → 12.94	OM 354.901		246-082-008-012C	SWP-M-C	T1: 1
(77 kW 3.9 Liter Pritsche/Fahrgestell 4x2 5.6 t)					
06.94 → 12.94	OM 354.902		246-082-008-012C	SWP-M-C	T1: 1
(77 kW 3.9 Liter Kipper 4x2 5.6 t)					
06.94 → 12.94	OM 354.901		246-082-008-012C	SWP-M-C	T1: 1
(63 kW → 66 kW 3.9 Liter Kasten/Kombi 4x2 7.0 t)					
04.86 → 12.94	OM 364.906 / OM 364.912 / OM 364.921		246-082-008-012C	SWP-M-C	T1: 1
(63 kW → 66 kW 3.9 Liter Pritsche/Fahrgestell 4x2 7.0 t)					
04.86 → 12.94	OM 364.906 / OM 364.912 / OM 364.921		246-082-008-012C	SWP-M-C	T1: 1
(63 kW → 66 kW 3.9 Liter Kipper 4x2 7.0 t)					
04.86 → 12.94	OM 364.906 / OM 364.921		246-082-008-012C	SWP-M-C	T1: 1
(77 kW → 85 kW 3.9 Liter Kasten/Kombi 4x2 7.0 t)					
04.86 → 12.94	OM 354.902 / OM 354.903 / OM 364.950 / OM 364.952 / OM 364.957		246-082-008-012C	SWP-M-C	T1: 1
(77 kW → 85 kW 3.9 Liter Pritsche/Fahrgestell 4x2 7.0 t)					
04.86 → 12.94	OM 354.902 / OM 354.903 / OM 364.950 / OM 364.952 / OM 364.957		246-082-008-012C	SWP-M-C	T1: 1
(103 kW 3.9 Liter Kasten/Kombi 4x2 7.0 t)					
06.94 → 12.94	OM 354.923		246-082-008-012C	SWP-M-C	T1: 1
(103 kW 3.9 Liter Pritsche/Fahrgestell 4x2 7.0 t)					
06.94 → 12.94	OM 354.923		246-082-008-012C	SWP-M-C	T1: 1
(63 kW → 66 kW 3.9 Liter Kasten/Kombi 4x2 8.0 t)					
04.86 → 12.94	OM 364.906 / OM 364.911 / OM 364.920 / OM 364.921		246-082-008-012C	SWP-M-C	T1: 1
(63 kW → 66 kW 3.9 Liter Pritsche/Fahrgestell 4x2 8.0 t)					
04.86 → 12.94	OM 364.906 / OM 364.911 / OM 364.920 / OM 364.921		246-082-008-012C	SWP-M-C	T1: 1
(63 kW → 66 kW 3.9 Liter Kipper 4x2 8.0 t)					
04.86 → 12.94	OM 364.906 / OM 364.911 / OM 364.920 / OM 364.921		246-082-008-012C	SWP-M-C	T1: 1
(63 kW → 66 kW 3.9 Liter Triebkopf 4x2 8.0 t)					
04.86 → 12.94	OM 364.906 / OM 364.911 / OM 364.920 / OM 364.921		246-082-008-012C	SWP-M-C	T1: 1



Datum	Motorcode	Fahrgestell Nr.	Artikel Nr.	Artikelbez.	Information
-------	-----------	-----------------	-------------	-------------	-------------

MERCEDES-BENZ

T2/LN1

(77 kW → 85 kW 3.9 Liter Kasten/Kombi 4x2 8.0 t)					
04.86 → 12.94	OM 354.901 / OM 354.903 / OM 364.950 / OM 364.952 / OM 364.958		246-082-008-012C	SWP-M-C	T1: 1
(77 kW → 85 kW 3.9 Liter Pritsche/Fahrgestell 4x2 8.0 t)					
04.86 → 12.94	OM 354.901 / OM 354.903 / OM 364.950 / OM 364.952 / OM 364.958		246-082-008-012C	SWP-M-C	T1: 1
(77 kW → 85 kW 3.9 Liter Kipper 4x2 8.0 t)					
04.86 → 12.94	OM 354.901 / OM 354.903 / OM 364.950 / OM 364.952 / OM 364.958		246-082-008-012C	SWP-M-C	T1: 1
(100 kW → 103 kW 3.9 Liter Kasten/Kombi 4x2 8.0 t)					
11.87 → 12.94	OM 354.924 / OM 364.981 / OM 364.986		246-082-008-012C	SWP-M-C	T1: 1
(100 kW → 103 kW 3.9 Liter Pritsche/Fahrgestell 4x2 8.0 t)					
11.87 → 12.94	OM 354.924 / OM 364.981 / OM 364.986		246-082-008-012C	SWP-M-C	T1: 1
(100 kW → 103 kW 3.9 Liter Kasten/Kombi 4x4 8.0 t)					
11.87 → 12.94	OM 354.925 / OM 364.984 / OM 364.987		246-082-008-012C	SWP-M-C	T1: 1
(100 kW → 103 kW 3.9 Liter Pritsche/Fahrgestell 4x4 8.0 t)					
11.87 → 12.94	OM 354.925 / OM 364.984 / OM 364.987		246-082-008-012C	SWP-M-C	T1: 1
(66 kW 3.9 Liter Bus 4x2 6.4 t)					
07.87 → 12.92	OM 364.913		246-082-008-012C	SWP-M-C	T1: 1
(85 kW 3.9 Liter Bus 4x2 6.4 t)					
07.87 → 12.92	OM 364.952 / OM 364.954		246-082-008-012C	SWP-M-C	T1: 1

VARIO

(100 kW 4.2 Liter Pritsche/Fahrgestell 4x2 5.99 t)					
09.96 →	OM 904.908		246-082-008-012C	SWP-M-C	T1: 1
(100 kW 4.2 Liter Kasten/Kombi 4x2 5.99 t)					
09.96 →	OM 904.908		246-082-008-012C	SWP-M-C	T1: 1
(100 kW 4.2 Liter Kipper 4x2 5.99 t)					
09.96 →	OM 904.908		246-082-008-012C	SWP-M-C	T1: 1
(112 kW 4.2 Liter Pritsche/Fahrgestell 4x2 5.99 t)					
09.98 →	OM 904.923		246-082-008-012C	SWP-M-C	T1: 1
(112 kW 4.2 Liter Kasten/Kombi 4x2 5.99 t)					
09.98 →	OM 904.923		246-082-008-012C	SWP-M-C	T1: 1
(112 kW 4.2 Liter Kipper 4x2 5.99 t)					
09.98 →	OM 904.923		246-082-008-012C	SWP-M-C	T1: 1
(100 kW 4.2 Liter Pritsche/Fahrgestell 4x2 7.49 t)					
09.96 →	OM 904.908		246-082-008-012C	SWP-M-C	T1: 1



Datum	Motorcode	Fahrgestell Nr.	Artikel Nr.	Artikelbez.	Information
-------	-----------	-----------------	-------------	-------------	-------------

MERCEDES-BENZ

VARIO

(100 kW 4.2 Liter Kasten/Kombi 4x2 7.49 t)					
09.96 →	OM 904.908		246-082-008-012C	SWP-M-C	T1: 1
(100 kW 4.2 Liter Kipper 4x2 7.49 t)					
09.96 →	OM 904.908		246-082-008-012C	SWP-M-C	T1: 1
(100 kW 4.2 Liter Pritsche/Fahrgestell 4x4 7.49 t)					
09.96 →	OM 904.908		246-082-008-012C	SWP-M-C	T1: 1
(100 kW 4.2 Liter Kasten/Kombi 4x4 7.49 t)					
09.96 →	OM 904.908		246-082-008-012C	SWP-M-C	T1: 1
(100 kW 4.2 Liter Kipper 4x4 7.49 t)					
09.96 →	OM 904.908		246-082-008-012C	SWP-M-C	T1: 1
(112 kW 4.2 Liter Pritsche/Fahrgestell 4x2 7.49 t)					
09.96 →	OM 904.923		246-082-008-012C	SWP-M-C	T1: 1
(112 kW 4.2 Liter Kasten/Kombi 4x2 7.49 t)					
09.96 →	OM 904.923		246-082-008-012C	SWP-M-C	T1: 1
(112 kW 4.2 Liter Kipper 4x2 7.49 t)					
09.96 →	OM 904.923		246-082-008-012C	SWP-M-C	T1: 1
(112 kW 4.2 Liter Pritsche/Fahrgestell 4x4 7.49 t)					
09.96 →	OM 904.923		246-082-008-012C	SWP-M-C	T1: 1
(112 kW 4.2 Liter Kasten/Kombi 4x4 7.49 t)					
09.96 →	OM 904.923		246-082-008-012C	SWP-M-C	T1: 1
(112 kW 4.2 Liter Kipper 4x4 7.49 t)					
09.96 →	OM 904.923		246-082-008-012C	SWP-M-C	T1: 1
(100 kW 4.2 Liter Bus 4x2 7.49 t)					
09.96 →	OM 904.908		246-082-008-012C	SWP-M-C	T1: 1

SCANIA

Serie 3

(162 kW 8.4 Liter Pritsche/Fahrgestell 4x2 18.0 t)					
12.91 → 12.96	DSC 9.10		246-075-044-003A	SWP-M-G	T1: 2
(185 kW 8.4 Liter Kipper 4x4 18.0 t)					
01.90 → 12.96	DS 9.05 / DSC 9.07		246-075-044-003A	SWP-M-G	T1: 2
(185 kW 8.4 Liter Pritsche/Fahrgestell 6x4 26.0 t)					
01.90 → 12.96	DS 9.05 / DSC 9.07		246-075-044-003A	SWP-M-G	T1: 2
(185 kW 8.4 Liter Betonmischer 6x4 26.0 t)					
01.90 → 12.96	DS 9.05 / DSC 9.07		246-075-044-003A	SWP-M-G	T1: 2
(185 kW 8.4 Liter Pritsche/Fahrgestell 4x2 18.0 t)					
01.90 → 12.96	DS 9.05 / DSC 9.07		246-075-044-003A	SWP-M-G	T1: 2
(185 kW 8.4 Liter Kipper 6x4 24.0 t)					
01.89 → 12.89	DS 9.05		246-075-044-003A	SWP-M-G	T1: 2
(185 kW 8.4 Liter Kipper 6x4 26.0 t)					
01.90 → 12.96	DS 9.05 / DSC 9.07		246-075-044-003A	SWP-M-G	T1: 2



Datum	Motorcode	Fahrgestell Nr.	Artikel Nr.	Artikelbez.	Information
-------	-----------	-----------------	-------------	-------------	-------------

SCANIA

Serie 3

(185 kW 8.4 Liter Kipper 4x4 17.0 t)					
03.88 → 12.89	DS 9.05		246-075-044-003A	SWP-M-G	T1: 2
(207 kW → 208 kW 8.4 Liter Pritsche/Fahrgestell 6x4 26.0 t)					
12.91 → 12.96	DSC 9.02 / DSC 9.08		246-075-044-003A	SWP-M-G	T1: 2
(207 kW → 208 kW 8.4 Liter Kipper 6x4 18.0 t)					
12.91 → 12.96	DSC 9.02 / DSC 9.08		246-075-044-003A	SWP-M-G	T1: 2
(207 kW → 208 kW 8.4 Liter Pritsche/Fahrgestell 4x2 18.0 t)					
12.91 → 12.96	DSC 9.02 / DSC 9.08		246-075-044-003A	SWP-M-G	T1: 2
(207 kW → 208 kW 8.4 Liter Betonmischer 6x4 26.0 t)					
12.91 → 12.96	DSC 9.02 / DSC 9.08		246-075-044-003A	SWP-M-G	T1: 2
(207 kW → 208 kW 8.4 Liter Kipper 6x4 26.0 t)					
12.91 → 12.96	DSC 9.02 / DSC 9.08		246-075-044-003A	SWP-M-G	T1: 2
(155 kW 8.4 Liter Pritsche/Fahrgestell 4x2 17.0 t)					
03.88 → 12.91	DS 9.08		246-075-044-003A	SWP-M-G	T1: 2
(162 kW 8.4 Liter Pritsche/Fahrgestell 4x2 18.0 t)					
12.91 → 12.96	DSC 9.10		246-075-044-003A	SWP-M-G	T1: 2
(162 kW 8.4 Liter Sattelzugmaschine 4x2 18.0 t)					
12.91 → 12.96	DSC 9.10		246-075-044-003A	SWP-M-G	T1: 2
(162 kW 8.4 Liter Pritsche/Fahrgestell 6x2/2/4 25.0 t)					
12.91 → 12.96	DSC 9.10		246-075-044-003A	SWP-M-G	T1: 2
(167 kW 8.4 Liter Pritsche/Fahrgestell 4x2 17.0 t)					
03.88 → 12.89	DS 9.06		246-075-044-003A	SWP-M-G	T1: 2
(167 kW 8.4 Liter Pritsche/Fahrgestell 4x2 18.0 t)					
01.90 → 12.91	DS 9.06		246-075-044-003A	SWP-M-G	T1: 2
(167 kW 8.4 Liter Sattelzugmaschine 4x2 17.0 t)					
03.88 → 12.89	DS 9.06		246-075-044-003A	SWP-M-G	T1: 2
(167 kW 8.4 Liter Pritsche/Fahrgestell 6x2 24.0 t)					
03.88 → 12.89	DS 9.06		246-075-044-003A	SWP-M-G	T1: 2
(167 kW 8.4 Liter Pritsche/Fahrgestell 6x2 25.0 t)					
01.90 → 12.91	DS 9.06		246-075-044-003A	SWP-M-G	T1: 2
(167 kW 8.4 Liter Sattelzugmaschine 4x2 18.0 t)					
01.90 → 12.91	DS 9.06		246-075-044-003A	SWP-M-G	T1: 2
(185 kW 8.4 Liter Pritsche/Fahrgestell 6x2/2/4 25.0 t)					
01.90 → 12.96	DS 9.05 / DSC 9.07		246-075-044-003A	SWP-M-G	T1: 2
(185 kW 8.4 Liter Sattelzugmaschine 4x2 17.0 t)					
03.88 → 12.89	DS 9.05		246-075-044-003A	SWP-M-G	T1: 2
(185 kW 8.4 Liter Pritsche/Fahrgestell 4x2 18.0 t)					
01.90 → 12.96	DS 9.05 / DSC 9.07		246-075-044-003A	SWP-M-G	T1: 2
(185 kW 8.4 Liter Kipper 6x4 26.0 t)					
01.90 → 12.96	DS 9.05 / DSC 9.07		246-075-044-003A	SWP-M-G	T1: 2
(185 kW 8.4 Liter Pritsche/Fahrgestell 6x4 26.0 t)					
01.90 → 12.96	DS 9.05 / DSC 9.07		246-075-044-003A	SWP-M-G	T1: 2
(185 kW 8.4 Liter Sattelzugmaschine 4x2 18.0 t)					
01.90 → 12.96	DS 9.05 / DSC 9.07		246-075-044-003A	SWP-M-G	T1: 2



Datum	Motorcode	Fahrgestell Nr.	Artikel Nr.	Artikelbez.	Information
-------	-----------	-----------------	-------------	-------------	-------------

SCANIA

Serie 3

(185 kW 8.4 Liter Kipper 4x4 18.0 t)					
01.90 → 12.96	DS 9.05 / DSC 9.07		246-075-044-003A	SWP-M-G	T1: 2
(185 kW 8.4 Liter Pritsche/Fahrgestell 4x2 17.0 t)					
03.88 → 12.89	DS 9.05		246-075-044-003A	SWP-M-G	T1: 2
(185 kW 8.4 Liter Pritsche/Fahrgestell 6x2/2/4 24.0 t)					
03.88 → 12.89	DS 9.05		246-075-044-003A	SWP-M-G	T1: 2
(185 kW 8.4 Liter Betonmischer 6x4 26.0 t)					
10.90 → 12.96	DS 9.05 / DSC 9.07		246-075-044-003A	SWP-M-G	T1: 2
(207 kW 8.4 Liter Sattelzugmaschine 4x2 17.0 t)					
03.88 → 12.89	DSC 9.02		246-075-044-003A	SWP-M-G	T1: 2
(207 kW → 208 kW 8.4 Liter Pritsche/Fahrgestell 4x2 18.0 t)					
01.90 → 12.96	DSC 9.02 / DSC 9.08		246-075-044-003A	SWP-M-G	T1: 2
(207 kW → 208 kW 8.4 Liter Sattelzugmaschine 4x2 18.0 t)					
01.90 → 12.96	DSC 9.02 / DSC 9.08		246-075-044-003A	SWP-M-G	T1: 2
(207 kW → 208 kW 8.4 Liter Betonmischer 6x4 26.0 t)					
01.90 → 12.96	DSC 9.02 / DSC 9.08		246-075-044-003A	SWP-M-G	T1: 2
(207 kW 8.4 Liter Pritsche/Fahrgestell 4x2 17.0 t)					
03.88 → 12.89	DSC 9.02		246-075-044-003A	SWP-M-G	T1: 2
(207 kW → 208 kW 8.4 Liter Kipper 6x4 26.0 t)					
01.90 → 12.96	DSC 9.02 / DSC 9.08		246-075-044-003A	SWP-M-G	T1: 2
(207 kW → 208 kW 8.4 Liter Pritsche/Fahrgestell 6x2/2/4 25.0 t)					
01.90 → 12.96	DSC 9.02 / DSC 9.08		246-075-044-003A	SWP-M-G	T1: 2
(207 kW → 208 kW 8.4 Liter Pritsche/Fahrgestell 6x4 26.0 t)					
01.90 → 12.96	DSC 9.02 / DSC 9.08		246-075-044-003A	SWP-M-G	T1: 2
(207 kW 8.4 Liter Pritsche/Fahrgestell 6x2 24.0 t)					
03.88 → 12.89	DSC 9.02		246-075-044-003A	SWP-M-G	T1: 2

Serie 4

(191 kW 9.0 Liter Pritsche/Fahrgestell 4x2 18.0 t)					
12.96 →	DSC 9.12	1257631 →; 4427279 →; 9049831 →	246-075-044-003A	SWP-M-G	T1: 2
(191 kW 9.0 Liter Kipper 4x2 18.0 t)					
12.96 →	DSC 9.12	1257631 →; 4427279 →; 9049831 →	246-075-044-003A	SWP-M-G	T1: 2
(191 kW 9.0 Liter Kipper 4x4 18.0 t)					
12.96 →	DSC 9.12	1257631 →; 4427279 →; 9049831 →	246-075-044-003A	SWP-M-G	T1: 2
(191 kW 9.0 Liter Pritsche/Fahrgestell 6x4 26.0 t)					
12.96 →	DSC 9.12	1257631 →; 4427279 →; 9049831 →	246-075-044-003A	SWP-M-G	T1: 2



Datum	Motorcode	Fahrgestell Nr.	Artikel Nr.	Artikelbez.	Information
-------	-----------	-----------------	-------------	-------------	-------------

SCANIA

Serie 4

(191 kW 9.0 Liter Kipper 6x4 26.0 t)					
12.96 →	DSC 9.12	1257631 →; 4427279 →; 9049831 →	246-075-044-003A	SWP-M-G	T1: 2
(191 kW 9.0 Liter Kipper 6x6 26.0 t)					
12.96 →	DSC 9.12	1257631 →; 4427279 →; 9049831 →	246-075-044-003A	SWP-M-G	T1: 2
(191 kW 9.0 Liter Kipper 8x4/4 32.0 t)					
12.96 →	DSC 9.12	1257631 →; 4427279 →; 9049831 →	246-075-044-003A	SWP-M-G	T1: 2
(228 kW 9.0 Liter Pritsche/Fahrgestell 4x2 18.0 t)					
08.96 →	DSC 9.13 / DSC 9.15	1257631 →; 4427279 →; 9049831 →	246-075-044-003A	SWP-M-G	T1: 2
(228 kW 9.0 Liter Sattelzugmaschine 4x2 18.0 t)					
08.96 →	DSC 9.13 / DSC 9.15	1257631 →; 4427279 →; 9049831 →	246-075-044-003A	SWP-M-G	T1: 2
(228 kW 9.0 Liter Kipper 4x2 18.0 t)					
08.96 →	DSC 9.13 / DSC 9.15	1257631 →; 4427279 →; 9049831 →	246-075-044-003A	SWP-M-G	T1: 2
(228 kW 9.0 Liter Kipper 4x4 18.0 t)					
08.96 →	DSC 9.13 / DSC 9.15	1257631 →; 4427279 →; 9049831 →	246-075-044-003A	SWP-M-G	T1: 2
(228 kW 9.0 Liter Pritsche/Fahrgestell 6x2 26.0 t)					
08.96 →	DSC 9.13 / DSC 9.15	1257631 →; 4427279 →; 9049831 →	246-075-044-003A	SWP-M-G	T1: 2
(228 kW 9.0 Liter Pritsche/Fahrgestell 6x4 26.0 t)					
08.96 →	DSC 9.13 / DSC 9.15	1257631 →; 4427279 →; 9049831 →	246-075-044-003A	SWP-M-G	T1: 2
(228 kW 9.0 Liter Kipper 6x4 26.0 t)					
08.96 →	DSC 9.13 / DSC 9.15	1257631 →; 4427279 →; 9049831 →	246-075-044-003A	SWP-M-G	T1: 2
(228 kW 9.0 Liter Kipper 6x6 26.0 t)					
08.96 →	DSC 9.13 / DSC 9.15	1257631 →; 4427279 →; 9049831 →	246-075-044-003A	SWP-M-G	T1: 2



Datum	Motorcode	Fahrgestell Nr.	Artikel Nr.	Artikelbez.	Information
-------	-----------	-----------------	-------------	-------------	-------------

SCANIA

Serie 4

(228 kW 9.0 Liter Kipper 8x4/4 32.0 t)					
08.96 →	DSC 9.13 / DSC 9.15	1257631 →; 4427279 →; 9049831 →	246-075-044-003A	SWP-M-G	T1: 2
(162 kW 9.0 Liter Pritsche/Fahrgestell 4x2 18.0 t)					
08.96 →	DSC 9.11	1257631 →; 4427279 →; 9049831 →	246-075-044-003A	SWP-M-G	T1: 2
(162 kW 9.0 Liter Sattelzugmaschine 4x2 18.0 t)					
08.96 →	DSC 9.11	1257631 →; 4427279 →; 9049831 →	246-075-044-003A	SWP-M-G	T1: 2
(162 kW 9.0 Liter Pritsche/Fahrgestell 6x2/2/4 25.0 t)					
08.96 →	DSC 9.11	1257631 →; 4427279 →; 9049831 →	246-075-044-003A	SWP-M-G	T1: 2
(169 kW 9.0 Liter Pritsche/Fahrgestell 6x2/2/4 25.0 t)					
08.99 →	DC 9.01 / DC 9.04	1257631 →; 4427279 →; 9049831 →	246-075-044-003A	SWP-M-G	T1: 2
(169 kW 9.0 Liter Pritsche/Fahrgestell 4x2 18.0 t)					
08.99 →	DC 9.01 / DC 9.04	1257631 →; 4427279 →; 9049831 →	246-075-044-003A	SWP-M-G	T1: 2
(169 kW 9.0 Liter Sattelzugmaschine 4x2 18.0 t)					
08.99 →	DC 9.01 / DC 9.04	1257631 →; 4427279 →; 9049831 →	246-075-044-003A	SWP-M-G	T1: 2
(191 kW 9.0 Liter Pritsche/Fahrgestell 4x2 18.0 t)					
08.96 →	DSC 9.12	1257631 →; 4427279 →; 9049831 →	246-075-044-003A	SWP-M-G	T1: 2
(191 kW 9.0 Liter Sattelzugmaschine 4x2 18.0 t)					
08.96 →	DSC 9.12	1257631 →; 4427279 →; 9049831 →	246-075-044-003A	SWP-M-G	T1: 2
(191 kW 9.0 Liter Pritsche/Fahrgestell 6x2/2/4 25.0 t)					
08.96 →	DSC 9.12	1257631 →; 4427279 →; 9049831 →	246-075-044-003A	SWP-M-G	T1: 2
(228 kW 9.0 Liter Pritsche/Fahrgestell 4x2 18.0 t)					
12.96 →	DSC 9.13 / DSC 9.15	1257631 →; 4427279 →; 9049831 →	246-075-044-003A	SWP-M-G	T1: 2



Datum	Motorcode	Fahrgestell Nr.	Artikel Nr.	Artikelbez.	Information
-------	-----------	-----------------	-------------	-------------	-------------

SCANIA

Serie 4

(228 kW 9.0 Liter Sattelzugmaschine 4x2 18.0 t)					
12.96 →	DSC 9.13 / DSC 9.15	1257631 →; 4427279 →; 9049831 →	246-075-044-003A	SWP-M-G	T1: 2
(228 kW 9.0 Liter Pritsche/Fahrgestell 6x2/2/4 26.0 t)					
01.98 →	DSC 9.13 / DSC 9.15	1257631 →; 4427279 →; 9049831 →	246-075-044-003A	SWP-M-G	T1: 2
(162 kW 9.0 Liter Pritsche/Fahrgestell 4x2 18.0 t)					
08.96 →	DSC 9.11	1257631 →; 4427279 →; 9049831 →	246-075-044-003A	SWP-M-G	T1: 2
(162 kW 9.0 Liter Pritsche/Fahrgestell 6x2/2/4 25.0 t)					
01.98 →	DSC 9.11	1257631 →; 4427279 →; 9049831 →	246-075-044-003A	SWP-M-G	T1: 2
(162 kW 9.0 Liter Sattelzugmaschine 4x2 18.0 t)					
08.96 →	DSC 9.11	1257631 →; 4427279 →; 9049831 →	246-075-044-003A	SWP-M-G	T1: 2
(191 kW 9.0 Liter Pritsche/Fahrgestell 6x2/2/4 25.0 t)					
01.98 →	DSC 9.12	1257631 →; 4427279 →; 9049831 →	246-075-044-003A	SWP-M-G	T1: 2
(191 kW 9.0 Liter Sattelzugmaschine 4x2 18.0 t)					
08.96 →	DSC 9.12	1257631 →; 4427279 →; 9049831 →	246-075-044-003A	SWP-M-G	T1: 2
(191 kW 9.0 Liter Pritsche/Fahrgestell 4x2 18.0 t)					
08.96 →	DSC 9.12	1257631 →; 4427279 →; 9049831 →	246-075-044-003A	SWP-M-G	T1: 2
(228 kW 9.0 Liter Sattelzugmaschine 4x2 18.0 t)					
08.96 →	DSC 9.13 / DSC 9.15	1257631 →; 4427279 →; 9049831 →	246-075-044-003A	SWP-M-G	T1: 2
(228 kW 9.0 Liter Pritsche/Fahrgestell 4x2 18.0 t)					
08.96 →	DSC 9.13 / DSC 9.15	1257631 →; 4427279 →; 9049831 →	246-075-044-003A	SWP-M-G	T1: 2
(228 kW 9.0 Liter Pritsche/Fahrgestell 6x2/2/4 26.0 t)					
08.96 →	DSC 9.13 / DSC 9.15	1257631 →; 4427279 →; 9049831 →	246-075-044-003A	SWP-M-G	T1: 2



Datum	Motorcode	Fahrgestell Nr.	Artikel Nr.	Artikelbez.	Information
-------	-----------	-----------------	-------------	-------------	-------------

SCANIA

Serie 4

(228 kW 9.0 Liter Sattelzugmaschine 4x2 18.0 t)					
08.96 →	DSC 9.13 / DSC 9.15	1257631 →; 4427279 →; 9049831 →	246-075-044-003A	SWP-M-G	T1: 2
(228 kW 9.0 Liter Pritsche/Fahrgestell 4x2 18.0 t)					
08.96 →	DSC 9.13 / DSC 9.15	1257631 →; 4427279 →; 9049831 →	246-075-044-003A	SWP-M-G	T1: 2
(228 kW 9.0 Liter Sattelzugmaschine 6x4 26.0 t)					
08.96 →	DSC 9.13 / DSC 9.15	1257631 →; 4427279 →; 9049831 →	246-075-044-003A	SWP-M-G	T1: 2
(228 kW 9.0 Liter Pritsche/Fahrgestell 6x4 26.0 t)					
08.96 →	DSC 9.13 / DSC 9.15	1257631 →; 4427279 →; 9049831 →	246-075-044-003A	SWP-M-G	T1: 2
(228 kW 9.0 Liter Pritsche/Fahrgestell 6x2/2/4 26.0 t)					
08.96 →	DSC 9.13 / DSC 9.15	1257631 →; 4427279 →; 9049831 →	246-075-044-003A	SWP-M-G	T1: 2

VOLVO

F 10

(192 kW → 200 kW 9.6 Liter Pritsche/Fahrgestell 4x2 16.0 t)					
02.82 → 06.85	TD 100 G / TD 100 GA / TD 101 G		246-075-040-020C	SWP-M-G	T1: 1; T2: F
02.82 → 06.85	TD 100 G / TD 100 GA / TD 101 G	314 000 →; 338 991 →; 352 763 →	246-075-051-007C	SWP-M-G	T1: 2; T2: F
(192 kW → 200 kW 9.6 Liter Pritsche/Fahrgestell 6x2 22.0 t)					
02.82 → 06.85	TD 100 G / TD 100 GA / TD 101 G		246-075-040-020C	SWP-M-G	T1: 1; T2: F
02.82 → 06.85	TD 100 G / TD 100 GA / TD 101 G	314 000 →; 338 991 →; 352 763 →	246-075-051-007C	SWP-M-G	T1: 2; T2: F
(192 kW → 200 kW 9.6 Liter Pritsche/Fahrgestell 6x4 22.0 t)					
01.83 → 06.85	TD 100 G / TD 100 GA / TD 101 G		246-075-040-020C	SWP-M-G	T1: 1; T2: F
01.83 → 06.85	TD 100 G / TD 100 GA / TD 101 G	314 000 →; 338 991 →; 352 763 →	246-075-051-007C	SWP-M-G	T1: 2; T2: F



Datum	Motorcode	Fahrgestell Nr.	Artikel Nr.	Artikelbez.	Information
-------	-----------	-----------------	-------------	-------------	-------------

VOLVO**F 10**

(192 kW → 200 kW 9.6 Liter Kipper 4x2 16.0 t)					
02.82 → 06.85	TD 100 G / TD 100 GA / TD 101 G		246-075-040-020C	SWP-M-G	T1: 1; T2: F
02.82 → 06.85	TD 100 G / TD 100 GA / TD 101 G	314 000 →; 338 991 →; 352 763 →	246-075-051-007C	SWP-M-G	T1: 2; T2: F
(192 kW → 200 kW 9.6 Liter Sattelzugmaschine 4x2 16.0 t)					
02.82 → 06.85	TD 100 G / TD 100 GA / TD 101 G		246-075-040-020C	SWP-M-G	T1: 1; T2: F
02.82 → 06.85	TD 100 G / TD 100 GA / TD 101 G	314 000 →; 338 991 →; 352 763 →	246-075-051-007C	SWP-M-G	T1: 2; T2: F
(192 kW → 200 kW 9.6 Liter Sattelzugmaschine 6x2 22.0 t)					
02.82 → 06.85	TD 100 G / TD 100 GA / TD 101 G		246-075-040-020C	SWP-M-G	T1: 1; T2: F
02.82 → 06.85	TD 100 G / TD 100 GA / TD 101 G	314 000 →; 338 991 →; 352 763 →	246-075-051-007C	SWP-M-G	T1: 2; T2: F
(192 kW → 200 kW 9.6 Liter Sattelzugmaschine 6x4 22.0 t)					
02.82 → 06.85	TD 100 G / TD 100 GA / TD 101 G		246-075-040-020C	SWP-M-G	T1: 1; T2: F
02.82 → 06.85	TD 100 G / TD 100 GA / TD 101 G	314 000 →; 338 991 →; 352 763 →	246-075-051-007C	SWP-M-G	T1: 2; T2: F
(206 kW → 207 kW 9.6 Liter Pritsche/Fahrgestell 4x2 16.0 t)					
08.77 → 02.82	TD 100 B		246-075-040-020C	SWP-M-G	T1: 1; T2: F
08.77 → 02.82	TD 100 B	314 000 →; 338 991 →; 352 763 →	246-075-051-007C	SWP-M-G	T1: 2; T2: F
(206 kW → 207 kW 9.6 Liter Pritsche/Fahrgestell 6x2 22.0 t)					
08.77 → 02.82	TD 100 B		246-075-040-020C	SWP-M-G	T1: 1; T2: F
08.77 → 02.82	TD 100 B	314 000 →; 338 991 →; 352 763 →	246-075-051-007C	SWP-M-G	T1: 2; T2: F
(206 kW → 207 kW 9.6 Liter Kipper 4x2 16.0 t)					
08.77 → 02.82	TD 100 B		246-075-040-020C	SWP-M-G	T1: 1; T2: F
08.77 → 02.82	TD 100 B	314 000 →; 338 991 →; 352 763 →	246-075-051-007C	SWP-M-G	T1: 2; T2: F
(206 kW → 207 kW 9.6 Liter Sattelzugmaschine 4x2 16.0 t)					
08.77 → 02.82	TD 100 B		246-075-040-020C	SWP-M-G	T1: 1; T2: F
08.77 → 02.82	TD 100 B	314 000 →; 338 991 →; 352 763 →	246-075-051-007C	SWP-M-G	T1: 2; T2: F



Datum	Motorcode	Fahrgestell Nr.	Artikel Nr.	Artikelbez.	Information
-------	-----------	-----------------	-------------	-------------	-------------

VOLVO

F 10

(206 kW → 207 kW 9.6 Liter Sattelzugmaschine 6x2 22.0 t)					
08.77 → 02.82	TD 100 B		246-075-040-020C	SWP-M-G	T1: 1; T2: F
08.77 → 02.82	TD 100 B	314 000 →; 338 991 →; 352 763 →	246-075-051-007C	SWP-M-G	T1: 2; T2: F
(215 kW → 221 kW 9.6 Liter Pritsche/Fahrgestell 4x2 16.0 t)					
10.83 → 12.86	TD 101 F / TD 101 FA		246-075-040-020C	SWP-M-G	T1: 1; T2: F
10.83 → 12.86	TD 101 F / TD 101 FA	314 000 →; 338 991 →; 352 763 →	246-075-051-007C	SWP-M-G	T1: 2; T2: F
(215 kW → 220 kW 9.6 Liter Pritsche/Fahrgestell 4x2 17.0 t)					
01.87 → 12.87	TD 101 F / TD 101 FA		246-075-040-020C	SWP-M-G	T1: 1; T2: F
01.87 → 12.87	TD 101 F / TD 101 FA	314 000 →; 338 991 →; 352 763 →	246-075-051-007C	SWP-M-G	T1: 2; T2: F
(215 kW → 220 kW 9.6 Liter Pritsche/Fahrgestell 6x2 22.0 t)					
01.84 → 12.86	TD 101 F / TD 101 FA		246-075-040-020C	SWP-M-G	T1: 1; T2: F
01.84 → 12.86	TD 101 F / TD 101 FA	314 000 →; 338 991 →; 352 763 →	246-075-051-007C	SWP-M-G	T1: 2; T2: F
(215 kW → 220 kW 9.6 Liter Pritsche/Fahrgestell 6x2 24.0 t)					
01.87 → 12.87	TD 101 F / TD 101 FA		246-075-040-020C	SWP-M-G	T1: 1; T2: F
01.87 → 12.87	TD 101 F / TD 101 FA	314 000 →; 338 991 →; 352 763 →	246-075-051-007C	SWP-M-G	T1: 2; T2: F
(215 kW → 220 kW 9.6 Liter Sattelzugmaschine 4x2 16.0 t)					
01.84 → 12.86	TD 101 F / TD 101 FA		246-075-040-020C	SWP-M-G	T1: 1; T2: F
01.84 → 12.86	TD 101 F / TD 101 FA	314 000 →; 338 991 →; 352 763 →	246-075-051-007C	SWP-M-G	T1: 2; T2: F
(215 kW → 220 kW 9.6 Liter Sattelzugmaschine 6x2 22.0 t)					
01.84 → 12.86	TD 101 F / TD 101 FA		246-075-040-020C	SWP-M-G	T1: 1; T2: F
01.84 → 12.86	TD 101 F / TD 101 FA	314 000 →; 338 991 →; 352 763 →	246-075-051-007C	SWP-M-G	T1: 2; T2: F
(228 kW → 235 kW 9.6 Liter Pritsche/Fahrgestell 4x2 17.0 t)					
10.87 → 12.90	TD 102 F / TD 102 FBQ / TD 102 FDQ / TD 102 FF / TD 102 FL / TD 102 FM / TD 103 ES		246-075-040-020C	SWP-M-G	T1: 1; T2: F
10.87 → 12.90	TD 102 F / TD 102 FBQ / TD 102 FDQ / TD 102 FF / TD 102 FL / TD 102 FM / TD 103 ES	314 000 →; 338 991 →; 352 763 →	246-075-051-007C	SWP-M-G	T1: 2; T2: F



Datum	Motorcode	Fahrgestell Nr.	Artikel Nr.	Artikelbez.	Information
-------	-----------	-----------------	-------------	-------------	-------------

VOLVO**F 10**

(228 kW → 235 kW 9.6 Liter Pritsche/Fahrgestell 4x2 18.0 t)					
12.90 → 12.94	TD 102 F / TD 102 FBQ / TD 102 FDQ / TD 102 FF / TD 102 FL / TD 103 ES		246-075-040-020C	SWP-M-G	T1: 1; T2: F
12.90 → 12.94	TD 102 F / TD 102 FBQ / TD 102 FDQ / TD 102 FF / TD 102 FL / TD 103 ES	314 000 →; 338 991 →; 352 763 →	246-075-051-007C	SWP-M-G	T1: 2; T2: F
(228 kW → 235 kW 9.6 Liter Pritsche/Fahrgestell 6x2 24.0 t)					
10.87 → 12.90	TD 102 F / TD 102 FBQ / TD 102 FDQ / TD 102 FF / TD 102 FL / TD 102 FM / TD 103 ES		246-075-040-020C	SWP-M-G	T1: 1; T2: F
10.87 → 12.90	TD 102 F / TD 102 FBQ / TD 102 FDQ / TD 102 FF / TD 102 FL / TD 102 FM / TD 103 ES	314 000 →; 338 991 →; 352 763 →	246-075-051-007C	SWP-M-G	T1: 2; T2: F
(228 kW → 235 kW 9.6 Liter Pritsche/Fahrgestell 6x2 25.0 t)					
12.90 → 12.94	TD 102 F / TD 102 FBQ / TD 102 FDQ / TD 102 FF / TD 102 FL / TD 102 FM / TD 103 ES		246-075-040-020C	SWP-M-G	T1: 1; T2: F
12.90 → 12.94	TD 102 F / TD 102 FBQ / TD 102 FDQ / TD 102 FF / TD 102 FL / TD 102 FM / TD 103 ES	314 000 →; 338 991 →; 352 763 →	246-075-051-007C	SWP-M-G	T1: 2; T2: F
(228 kW → 235 kW 9.6 Liter Kipper 4x2 17.0 t)					
10.87 → 12.90	TD 102 F / TD 102 FBQ / TD 102 FDQ / TD 102 FF / TD 102 FL / TD 102 FM / TD 103 ES		246-075-040-020C	SWP-M-G	T1: 1; T2: F
10.87 → 12.90	TD 102 F / TD 102 FBQ / TD 102 FDQ / TD 102 FF / TD 102 FL / TD 102 FM / TD 103 ES	314 000 →; 338 991 →; 352 763 →	246-075-051-007C	SWP-M-G	T1: 2; T2: F
(228 kW → 235 kW 9.6 Liter Kipper 4x2 18.0 t)					
12.90 → 12.94	TD 102 F / TD 102 FBQ / TD 102 FDQ / TD 102 FF / TD 102 FL / TD 102 FM / TD 103 ES		246-075-040-020C	SWP-M-G	T1: 1; T2: F
12.90 → 12.94	TD 102 F / TD 102 FBQ / TD 102 FDQ / TD 102 FF / TD 102 FL / TD 102 FM / TD 103 ES	314 000 →; 338 991 →; 352 763 →	246-075-051-007C	SWP-M-G	T1: 2; T2: F



Datum	Motorcode	Fahrgestell Nr.	Artikel Nr.	Artikelbez.	Information
-------	-----------	-----------------	-------------	-------------	-------------

VOLVO

F 10

(228 kW → 235 kW | 9.6 Liter | Kipper | 6x4 | 26.0 t)

12.90 → 12.94	TD 102 F / TD 102 FBQ / TD 102 FDQ / TD 102 FF / TD 102 FL / TD 102 FM / TD 103 ES		246-075-040-020C	SWP-M-G	T1: 1; T2: F
12.90 → 12.94	TD 102 F / TD 102 FBQ / TD 102 FDQ / TD 102 FF / TD 102 FL / TD 102 FM / TD 103 ES	314 000 →; 338 991 →; 352 763 →	246-075-051-007C	SWP-M-G	T1: 2; T2: F

(228 kW → 235 kW | 9.6 Liter | Sattelzugmaschine | 4x2 | 17.0 t)

10.87 → 12.90	TD 102 F / TD 102 FBQ / TD 102 FDQ / TD 102 FF / TD 102 FL / TD 102 FM / TD 103 ES		246-075-040-020C	SWP-M-G	T1: 1; T2: F
10.87 → 12.90	TD 102 F / TD 102 FBQ / TD 102 FDQ / TD 102 FF / TD 102 FL / TD 102 FM / TD 103 ES	314 000 →; 338 991 →; 352 763 →	246-075-051-007C	SWP-M-G	T1: 2; T2: F

(228 kW → 235 kW | 9.6 Liter | Sattelzugmaschine | 4x2 | 18.0 t)

12.90 → 12.94	TD 102 F / TD 102 FBQ / TD 102 FDQ / TD 102 FF / TD 102 FL / TD 102 FM / TD 103 ES		246-075-040-020C	SWP-M-G	T1: 1; T2: F
12.90 → 12.94	TD 102 F / TD 102 FBQ / TD 102 FDQ / TD 102 FF / TD 102 FL / TD 102 FM / TD 103 ES	314 000 →; 338 991 →; 352 763 →	246-075-051-007C	SWP-M-G	T1: 2; T2: F

(228 kW → 235 kW | 9.6 Liter | Sattelzugmaschine | 6x2 | 24.0 t)

10.87 → 12.90	TD 102 F / TD 102 FBQ / TD 102 FDQ / TD 102 FF / TD 102 FL / TD 102 FM / TD 103 ES		246-075-040-020C	SWP-M-G	T1: 1; T2: F
10.87 → 12.90	TD 102 F / TD 102 FBQ / TD 102 FDQ / TD 102 FF / TD 102 FL / TD 102 FM / TD 103 ES	314 000 →; 338 991 →; 352 763 →	246-075-051-007C	SWP-M-G	T1: 2; T2: F

(228 kW → 235 kW | 9.6 Liter | Sattelzugmaschine | 6x2 | 25.0 t)

12.90 → 12.94	TD 102 F / TD 102 FBQ / TD 102 FDQ / TD 102 FF / TD 102 FL / TD 102 FM / TD 103 ES		246-075-040-020C	SWP-M-G	T1: 1; T2: F
12.90 → 12.94	TD 102 F / TD 102 FBQ / TD 102 FDQ / TD 102 FF / TD 102 FL / TD 102 FM / TD 103 ES	314 000 →; 338 991 →; 352 763 →	246-075-051-007C	SWP-M-G	T1: 2; T2: F



Datum	Motorcode	Fahrgestell Nr.	Artikel Nr.	Artikelbez.	Information
-------	-----------	-----------------	-------------	-------------	-------------

VOLVO

F 12

(235 kW → 243 kW 11.9 Liter Pritsche/Fahrgestell 4x2 16.0 t)					
08.77 → 12.86	TD 120 G / TD 121 G / TD 121 GD	314 000 →; 338 991 →; 352 763 →	246-075-051-007C	SWP-M-G	T1: 2; T2: F
(235 kW 11.9 Liter Pritsche/Fahrgestell 4x2 17.0 t)					
01.87 → 12.87	TD 121 G	314 000 →; 338 991 →; 352 763 →	246-075-051-007C	SWP-M-G	T1: 2; T2: F
(235 kW → 243 kW 11.9 Liter Pritsche/Fahrgestell 6x2 22.0 t)					
08.77 → 12.86	TD 120 G / TD 121 G / TD 121 GD	314 000 →; 338 991 →; 352 763 →	246-075-051-007C	SWP-M-G	T1: 2; T2: F
(235 kW → 243 kW 11.9 Liter Pritsche/Fahrgestell 6x4 22.0 t)					
08.77 → 12.86	TD 120 G / TD 121 G / TD 121 GD	314 000 →; 338 991 →; 352 763 →	246-075-051-007C	SWP-M-G	T1: 2; T2: F
(235 kW 11.9 Liter Pritsche/Fahrgestell 6x2 24.0 t)					
01.87 → 12.87	TD 121 G	314 000 →; 338 991 →; 352 763 →	246-075-051-007C	SWP-M-G	T1: 2; T2: F
(235 kW 11.9 Liter Pritsche/Fahrgestell 6x4 24.0 t)					
01.87 → 12.87	TD 121 G	314 000 →; 338 991 →; 352 763 →	246-075-051-007C	SWP-M-G	T1: 2; T2: F
(235 kW → 243 kW 11.9 Liter Kipper 4x2 16.0 t)					
08.77 → 12.86	TD 120 G / TD 121 G / TD 121 GD	314 000 →; 338 991 →; 352 763 →	246-075-051-007C	SWP-M-G	T1: 2; T2: F
(235 kW 11.9 Liter Kipper 4x2 17.0 t)					
01.87 → 12.87	TD 121 G	314 000 →; 338 991 →; 352 763 →	246-075-051-007C	SWP-M-G	T1: 2; T2: F
(235 kW → 243 kW 11.9 Liter Sattelzugmaschine 4x2 16.0 t)					
08.77 → 12.86	TD 120 G / TD 121 G / TD 121 GD	314 000 →; 338 991 →; 352 763 →	246-075-051-007C	SWP-M-G	T1: 2; T2: F
(235 kW 11.9 Liter Sattelzugmaschine 4x2 17.0 t)					
01.87 → 12.87	TD 121 G	314 000 →; 338 991 →; 352 763 →	246-075-051-007C	SWP-M-G	T1: 2; T2: F
(235 kW → 243 kW 11.9 Liter Sattelzugmaschine 6x2 22.0 t)					
08.77 → 12.86	TD 120 G / TD 121 G / TD 121 GD	314 000 →; 338 991 →; 352 763 →	246-075-051-007C	SWP-M-G	T1: 2; T2: F



Datum	Motorcode	Fahrgestell Nr.	Artikel Nr.	Artikelbez.	Information
-------	-----------	-----------------	-------------	-------------	-------------

VOLVO

F 12

(235 kW → 243 kW 11.9 Liter Sattelzugmaschine 6x4 22.0 t)					
08.77 → 12.86	TD 120 G / TD 121 G / TD 121 GD	314 000 →; 338 991 →; 352 763 →	246-075-051-007C	SWP-M-G	T1: 2; T2: F
(235 kW 11.9 Liter Sattelzugmaschine 6x2 24.0 t)					
01.87 → 12.87	TD 121 G	314 000 →; 338 991 →; 352 763 →	246-075-051-007C	SWP-M-G	T1: 2; T2: F
(235 kW 11.9 Liter Sattelzugmaschine 6x4 24.0 t)					
01.87 → 12.87	TD 121 G	314 000 →; 338 991 →; 352 763 →	246-075-051-007C	SWP-M-G	T1: 2; T2: F
(262 kW 11.9 Liter Pritsche/Fahrgestell 4x2 17.0 t)					
01.88 → 12.90	TD 122 F / TD 122 FH	314 000 →; 338 991 →; 352 763 →	246-075-051-007C	SWP-M-G	T1: 2; T2: F
(262 kW 11.9 Liter Pritsche/Fahrgestell 4x2 18.0 t)					
12.90 → 12.94	TD 122 F / TD 122 FH	314 000 →; 338 991 →; 352 763 →	246-075-051-007C	SWP-M-G	T1: 2; T2: F
(262 kW 11.9 Liter Pritsche/Fahrgestell 6x2 24.0 t)					
01.88 → 12.90	TD 122 F / TD 122 FH	314 000 →; 338 991 →; 352 763 →	246-075-051-007C	SWP-M-G	T1: 2; T2: F
(262 kW 11.9 Liter Pritsche/Fahrgestell 6x4 24.0 t)					
01.88 → 12.90	TD 122 F / TD 122 FH	314 000 →; 338 991 →; 352 763 →	246-075-051-007C	SWP-M-G	T1: 2; T2: F
(262 kW 11.9 Liter Pritsche/Fahrgestell 6x2 25.0 t)					
12.90 → 12.94	TD 122 F / TD 122 FH	314 000 →; 338 991 →; 352 763 →	246-075-051-007C	SWP-M-G	T1: 2; T2: F
(262 kW 11.9 Liter Pritsche/Fahrgestell 6x4 25.0 t)					
12.90 → 12.94	TD 122 F / TD 122 FH	314 000 →; 338 991 →; 352 763 →	246-075-051-007C	SWP-M-G	T1: 2; T2: F
(262 kW 11.9 Liter Kipper 4x2 17.0 t)					
01.88 → 12.90	TD 122 F / TD 122 FH	314 000 →; 338 991 →; 352 763 →	246-075-051-007C	SWP-M-G	T1: 2; T2: F
(262 kW 11.9 Liter Kipper 4x2 18.0 t)					
12.90 → 12.94	TD 122 F / TD 122 FH	314 000 →; 338 991 →; 352 763 →	246-075-051-007C	SWP-M-G	T1: 2; T2: F



Datum	Motorcode	Fahrgestell Nr.	Artikel Nr.	Artikelbez.	Information
-------	-----------	-----------------	-------------	-------------	-------------

VOLVO

F 12

(262 kW 11.9 Liter Kipper 6x4 26.0 t)					
01.91 → 12.94	TD 122 F / TD 122 FH	314 000 →; 338 991 →; 352 763 →	246-075-051-007C	SWP-M-G	T1: 2; T2: F
(262 kW 11.9 Liter Sattelzugmaschine 4x2 17.0 t)					
01.88 → 12.90	TD 122 F / TD 122 FH	314 000 →; 338 991 →; 352 763 →	246-075-051-007C	SWP-M-G	T1: 2; T2: F
(262 kW 11.9 Liter Sattelzugmaschine 4x2 18.0 t)					
12.90 → 12.94	TD 122 F / TD 122 FH	314 000 →; 338 991 →; 352 763 →	246-075-051-007C	SWP-M-G	T1: 2; T2: F
(262 kW 11.9 Liter Sattelzugmaschine 6x2 24.0 t)					
01.88 → 12.90	TD 122 F / TD 122 FH	314 000 →; 338 991 →; 352 763 →	246-075-051-007C	SWP-M-G	T1: 2; T2: F
(262 kW 11.9 Liter Sattelzugmaschine 6x4 24.0 t)					
01.88 → 12.90	TD 122 F / TD 122 FH	314 000 →; 338 991 →; 352 763 →	246-075-051-007C	SWP-M-G	T1: 2; T2: F
(262 kW 11.9 Liter Sattelzugmaschine 6x2 25.0 t)					
12.90 → 12.94	TD 122 F / TD 122 FH	314 000 →; 338 991 →; 352 763 →	246-075-051-007C	SWP-M-G	T1: 2; T2: F
(262 kW 11.9 Liter Sattelzugmaschine 6x4 25.0 t)					
10.90 → 12.94	TD 122 F / TD 122 FH	314 000 →; 338 991 →; 352 763 →	246-075-051-007C	SWP-M-G	T1: 2; T2: F
(272 kW 11.9 Liter Pritsche/Fahrgestell 4x2 16.0 t)					
08.77 → 12.86	TD 121 F	314 000 →; 338 991 →; 352 763 →	246-075-051-007C	SWP-M-G	T1: 2; T2: F
(272 kW 11.9 Liter Pritsche/Fahrgestell 4x2 17.0 t)					
01.87 → 12.87	TD 121 F	314 000 →; 338 991 →; 352 763 →	246-075-051-007C	SWP-M-G	T1: 2; T2: F
(272 kW 11.9 Liter Pritsche/Fahrgestell 6x2 22.0 t)					
08.77 → 12.86	TD 121 F	314 000 →; 338 991 →; 352 763 →	246-075-051-007C	SWP-M-G	T1: 2; T2: F
(272 kW 11.9 Liter Pritsche/Fahrgestell 6x4 22.0 t)					
08.77 → 12.86	TD 121 F	314 000 →; 338 991 →; 352 763 →	246-075-051-007C	SWP-M-G	T1: 2; T2: F



Datum	Motorcode	Fahrgestell Nr.	Artikel Nr.	Artikelbez.	Information
-------	-----------	-----------------	-------------	-------------	-------------

VOLVO

F 12

(272 kW 11.9 Liter Pritsche/Fahrgestell 6x2 24.0 t)					
01.87 → 12.87	TD 121 F	314 000 →; 338 991 →; 352 763 →	246-075-051-007C	SWP-M-G	T1: 2; T2: F
(272 kW 11.9 Liter Pritsche/Fahrgestell 6x4 24.0 t)					
01.87 → 12.87	TD 121 F	314 000 →; 338 991 →; 352 763 →	246-075-051-007C	SWP-M-G	T1: 2; T2: F
(272 kW 11.9 Liter Sattelzugmaschine 4x2 16.0 t)					
08.77 → 12.86	TD 121 F	314 000 →; 338 991 →; 352 763 →	246-075-051-007C	SWP-M-G	T1: 2; T2: F
(272 kW 11.9 Liter Sattelzugmaschine 4x2 17.0 t)					
01.87 → 12.87	TD 121 F	314 000 →; 338 991 →; 352 763 →	246-075-051-007C	SWP-M-G	T1: 2; T2: F
(272 kW 11.9 Liter Sattelzugmaschine 6x2 22.0 t)					
08.77 → 12.86	TD 121 F	314 000 →; 338 991 →; 352 763 →	246-075-051-007C	SWP-M-G	T1: 2; T2: F
(272 kW 11.9 Liter Sattelzugmaschine 6x4 22.0 t)					
08.77 → 12.86	TD 121 F	314 000 →; 338 991 →; 352 763 →	246-075-051-007C	SWP-M-G	T1: 2; T2: F
(272 kW 11.9 Liter Sattelzugmaschine 6x2 24.0 t)					
01.87 → 12.87	TD 121 F	314 000 →; 338 991 →; 352 763 →	246-075-051-007C	SWP-M-G	T1: 2; T2: F
(272 kW 11.9 Liter Sattelzugmaschine 6x4 24.0 t)					
01.87 → 12.87	TD 121 F	314 000 →; 338 991 →; 352 763 →	246-075-051-007C	SWP-M-G	T1: 2; T2: F
(291 kW 11.9 Liter Pritsche/Fahrgestell 4x2 17.0 t)					
01.88 → 12.90	TD 122 FL / TD 122 FS	314 000 →; 338 991 →; 352 763 →	246-075-051-007C	SWP-M-G	T1: 2; T2: F
(291 kW 11.9 Liter Pritsche/Fahrgestell 4x2 18.0 t)					
12.90 → 12.94	TD 122 FL / TD 122 FS	314 000 →; 338 991 →; 352 763 →	246-075-051-007C	SWP-M-G	T1: 2; T2: F
(291 kW 11.9 Liter Pritsche/Fahrgestell 6x2 24.0 t)					
01.88 → 12.90	TD 122 FL / TD 122 FS	314 000 →; 338 991 →; 352 763 →	246-075-051-007C	SWP-M-G	T1: 2; T2: F



Datum	Motorcode	Fahrgestell Nr.	Artikel Nr.	Artikelbez.	Information
-------	-----------	-----------------	-------------	-------------	-------------

VOLVO

F 12

(291 kW 11.9 Liter Pritsche/Fahrgestell 6x4 24.0 t)					
01.88 → 12.90	TD 122 FL / TD 122 FS	314 000 →; 338 991 →; 352 763 →	246-075-051-007C	SWP-M-G	T1: 2; T2: F
(291 kW → 298 kW 11.9 Liter Pritsche/Fahrgestell 6x2 25.0 t)					
12.90 → 12.94	TD 122 FL / TD 122 FS / TD 123 ES	314 000 →; 338 991 →; 352 763 →	246-075-051-007C	SWP-M-G	T1: 2; T2: F
(291 kW → 298 kW 11.9 Liter Pritsche/Fahrgestell 6x4 25.0 t)					
12.90 → 12.94	TD 122 FL / TD 122 FS / TD 123 ES	314 000 →; 338 991 →; 352 763 →	246-075-051-007C	SWP-M-G	T1: 2; T2: F
(291 kW 11.9 Liter Sattelzugmaschine 4x2 17.0 t)					
01.88 → 12.90	TD 122 FL / TD 122 FS	314 000 →; 338 991 →; 352 763 →	246-075-051-007C	SWP-M-G	T1: 2; T2: F
(291 kW → 298 kW 11.9 Liter Sattelzugmaschine 4x2 18.0 t)					
12.90 → 12.94	TD 122 FL / TD 122 FS / TD 123 ES	314 000 →; 338 991 →; 352 763 →	246-075-051-007C	SWP-M-G	T1: 2; T2: F
(291 kW → 298 kW 11.9 Liter Sattelzugmaschine 6x2 24.0 t)					
01.88 → 12.94	TD 122 FL / TD 122 FS / TD 123 ES	314 000 →; 338 991 →; 352 763 →	246-075-051-007C	SWP-M-G	T1: 2; T2: F
(291 kW 11.9 Liter Sattelzugmaschine 6x4 24.0 t)					
01.88 → 12.90	TD 122 FL / TD 122 FS	314 000 →; 338 991 →; 352 763 →	246-075-051-007C	SWP-M-G	T1: 2; T2: F
(291 kW 11.9 Liter Sattelzugmaschine 6x2 25.0 t)					
12.90 → 12.94	TD 122 FL / TD 122 FS	314 000 →; 338 991 →; 352 763 →	246-075-051-007C	SWP-M-G	T1: 2; T2: F
(291 kW → 298 kW 11.9 Liter Sattelzugmaschine 6x4 25.0 t)					
12.90 → 12.94	TD 122 FL / TD 122 FS / TD 123 ES	314 000 →; 338 991 →; 352 763 →	246-075-051-007C	SWP-M-G	T1: 2; T2: F

F 16

(342 kW 16.1 Liter Pritsche/Fahrgestell 4x2 17.0 t)					
01.88 → 12.89	TD 162 F / TD 162 FJ / TD 162 FL / TD 162 FS		246-075-051-007C	SWP-M-G	T1: 2; T2: F
(342 kW 16.1 Liter Pritsche/Fahrgestell 6x2 24.0 t)					
01.88 → 12.89	TD 162 F / TD 162 FJ / TD 162 FL / TD 162 FS		246-075-051-007C	SWP-M-G	T1: 2; T2: F



Datum	Motorcode	Fahrgestell Nr.	Artikel Nr.	Artikelbez.	Information
-------	-----------	-----------------	-------------	-------------	-------------

VOLVO

F 16

(342 kW 16.1 Liter Sattelzugmaschine 4x2 17.0 t)					
01.88 → 12.89	TD 162 F / TD 162 FJ / TD 162 FL / TD 162 FS		246-075-051-007C	SWP-M-G	T1: 2; T2: F
(342 kW 16.1 Liter Sattelzugmaschine 6x4 24.0 t)					
01.88 → 12.89	TD 162 F / TD 162 FJ / TD 162 FL / TD 162 FS		246-075-051-007C	SWP-M-G	T1: 2; T2: F
(357 kW 16.1 Liter Pritsche/Fahrgestell 4x2 18.0 t)					
01.90 → 12.92	TD 162 F / TD 162 FJ / TD 162 FL / TD 162 FS		246-075-051-007C	SWP-M-G	T1: 2; T2: F
(357 kW 16.1 Liter Pritsche/Fahrgestell 6x2 25.0 t)					
01.90 → 12.92	TD 162 F / TD 162 FJ / TD 162 FL / TD 162 FS		246-075-051-007C	SWP-M-G	T1: 2; T2: F
(357 kW 16.1 Liter Pritsche/Fahrgestell 6x4 25.0 t)					
01.90 → 12.92	TD 162 F / TD 162 FJ / TD 162 FL / TD 162 FS		246-075-051-007C	SWP-M-G	T1: 2; T2: F
(357 kW 16.1 Liter Sattelzugmaschine 4x2 18.0 t)					
01.90 → 12.92	TD 162 F / TD 162 FJ / TD 162 FL / TD 162 FS		246-075-051-007C	SWP-M-G	T1: 2; T2: F
(357 kW 16.1 Liter Sattelzugmaschine 6x2 25.0 t)					
01.90 → 12.92	TD 162 F / TD 162 FJ / TD 162 FL / TD 162 FS		246-075-051-007C	SWP-M-G	T1: 2; T2: F
(357 kW 16.1 Liter Sattelzugmaschine 6x4 25.0 t)					
01.90 → 12.92	TD 162 F / TD 162 FJ / TD 162 FL / TD 162 FS		246-075-051-007C	SWP-M-G	T1: 2; T2: F
(368 kW 16.1 Liter Pritsche/Fahrgestell 4x2 18.0 t)					
01.92 → 12.94	TD 163 ES		246-075-051-007C	SWP-M-G	T1: 2; T2: F
(368 kW 16.1 Liter Pritsche/Fahrgestell 6x2 25.0 t)					
01.92 → 12.94	TD 163 ES		246-075-051-007C	SWP-M-G	T1: 2; T2: F
(368 kW 16.1 Liter Pritsche/Fahrgestell 6x4 26.0 t)					
01.92 → 12.94	TD 163 ES		246-075-051-007C	SWP-M-G	T1: 2; T2: F
(368 kW 16.1 Liter Sattelzugmaschine 4x2 18.0 t)					
01.92 → 12.94	TD 163 ES		246-075-051-007C	SWP-M-G	T1: 2; T2: F
(368 kW 16.1 Liter Sattelzugmaschine 6x2 24.0 t)					
01.92 → 12.94	TD 163 ES		246-075-051-007C	SWP-M-G	T1: 2; T2: F
(368 kW 16.1 Liter Sattelzugmaschine 6x4 25.0 t)					
01.92 → 12.94	TD 163 ES		246-075-051-007C	SWP-M-G	T1: 2; T2: F



OE Nr. > Artikel Nr. (sortiert nach Hersteller)	450
OE Nr. > Artikel Nr. (alle Hersteller)	464
Artikel Nr. > OE Nr. (sortiert nach Hersteller)	476
Artikel Nr. > OE Nr. (alle Hersteller)	490



Referenzliste

OE Nr. > Artikel Nr. (sortiert nach Hersteller)

OE Nr.	Artikel Nr.	Artikel Nr. (neu)	Artikelbezeichnung
0046797755	246-083-001-001	246-083-001-004C	SWP-D-C
0046797755	246-083-001-004C		SWP-D-C
0071719636	246-083-001-001	246-083-001-004C	SWP-D-C
0071719636	246-083-001-004C		SWP-D-C

ALFA ROMEO

AUDI

1J0 955 681	246-086-001-005	246-086-001-002C	HLWP
1J0 955 681	246-086-001-006	246-086-001-002C	HLWP
1J0 973 722 A	X11-246-003-014		A
1J5 955 651	246-082-008-015N	246-082-008-025G	SWP-M-C
1J5 955 651	246-082-008-017	246-082-008-025G	SWP-M-C
1J5 955 651	246-082-008-019	246-082-008-025G	SWP-M-C
1J5 955 651	246-082-008-022	246-082-008-025G	SWP-M-C
1J5 955 651	246-082-008-025G		SWP-M-C
1J5 955 651	246-082-008-026	246-082-008-025G	SWP-M-C
1J6 955 651	246-083-002-005C	246-083-002-022G	SWP-D-C
1J6 955 651	246-083-002-009	246-083-002-022G	SWP-D-C
1J6 955 651	246-083-002-010	246-083-002-022G	SWP-D-C
1J6 955 651	246-083-002-015	246-083-002-022G	SWP-D-C
1J6 955 651	246-083-002-019	246-083-002-022G	SWP-D-C
1J6 955 651	246-083-002-022G		SWP-D-C
1T0 955 651 A	246-083-002-005C	246-083-002-022G	SWP-D-C
1T0 955 651 A	246-083-002-009	246-083-002-022G	SWP-D-C
1T0 955 651 A	246-083-002-010	246-083-002-022G	SWP-D-C
1T0 955 651 A	246-083-002-015	246-083-002-022G	SWP-D-C
1T0 955 651 A	246-083-002-019	246-083-002-022G	SWP-D-C
1T0 955 651 A	246-083-002-022G		SWP-D-C
3B7 955 681	246-086-001-004	246-086-001-007C	HLWP
3B7 955 681	246-086-001-007C		HLWP
3B7 955 681	246-086-001-016	246-086-001-007C	HLWP
431 955 651	246-082-003-003	246-082-008-014C	SWP-M-C
431 955 651	246-082-003-005C	246-082-008-014C	SWP-M-C
431 955 651	246-082-003-007	246-082-008-014C	SWP-M-C
431 955 651	246-082-003-011	246-082-008-014C	SWP-M-C
431 955 651	246-082-003-016	246-082-008-014C	SWP-M-C
431 955 651	246-082-008-008	246-082-008-014C	SWP-M-C
431 955 651	246-082-008-009	246-082-008-014C	SWP-M-C
431 955 651	246-082-008-014C		SWP-M-C
823 955 651	246-075-015-016C	246-075-021-006C	SWP-M-G
823 955 651	246-075-021-001	246-075-021-006C	SWP-M-G
823 955 651	246-075-021-006C		SWP-M-G



OE Nr.	Artikel Nr.	Artikel Nr. (neu)	Artikelbezeichnung
BMW			
61 31 1 369 263	395-060-017-001C		FLS
61 66 1 350 885	88-326-001		C
61 66 1 355 299	246-063-013-001D		V
61 66 1 368 549	246-075-042-001C		SWP-M-G
61 66 1 368 549	246-082-003-013	246-075-042-001C	SWP-M-G
61 66 1 370 033	246-075-042-001C		SWP-M-G
61 66 1 370 033	246-082-003-013	246-075-042-001C	SWP-M-G
61 66 1 370 465	246-075-042-001C		SWP-M-G
61 66 1 370 465	246-082-003-013	246-075-042-001C	SWP-M-G
61 66 1 378 799	246-080-013-001Z		N-H
61 66 1 379 735	246-069-059-001Z		N
61 66 8 350 355	246-080-013-003Z		N-H
61 67 1 359 115	246-075-021-003	246-075-023-004C	SWP-M-G
61 67 1 359 115	246-075-023-003	246-075-023-004C	SWP-M-G
61 67 1 359 115	246-075-023-004C		SWP-M-G
61 67 1 359 116	246-075-021-003	246-075-023-004C	SWP-M-G
61 67 1 359 116	246-075-023-003	246-075-023-004C	SWP-M-G
61 67 1 359 116	246-075-023-004C		SWP-M-G
67 12 8 362 154	246-082-008-015N	246-082-008-025G	SWP-M-C
67 12 8 362 154	246-082-008-017	246-082-008-025G	SWP-M-C
67 12 8 362 154	246-082-008-019	246-082-008-025G	SWP-M-C
67 12 8 362 154	246-082-008-022	246-082-008-025G	SWP-M-C
67 12 8 362 154	246-082-008-025G		SWP-M-C
67 12 8 362 154	246-082-008-026	246-082-008-025G	SWP-M-C
67 12 8 377 430	246-086-001-004	246-086-001-007C	HLWP
67 12 8 377 430	246-086-001-007C		HLWP
67 12 8 377 430	246-086-001-016	246-086-001-007C	HLWP
67 12 8 377 612	246-082-008-015N	246-082-008-025G	SWP-M-C
67 12 8 377 612	246-082-008-017	246-082-008-025G	SWP-M-C
67 12 8 377 612	246-082-008-019	246-082-008-025G	SWP-M-C
67 12 8 377 612	246-082-008-022	246-082-008-025G	SWP-M-C
67 12 8 377 612	246-082-008-025G		SWP-M-C
67 12 8 377 612	246-082-008-026	246-082-008-025G	SWP-M-C
67 12 8 377 613	246-086-001-004	246-086-001-007C	HLWP
67 12 8 377 613	246-086-001-007C		HLWP
67 12 8 377 613	246-086-001-016	246-086-001-007C	HLWP
67 12 8 377 987	246-083-002-005C	246-083-002-022G	SWP-D-C
67 12 8 377 987	246-083-002-009	246-083-002-022G	SWP-D-C
67 12 8 377 987	246-083-002-010	246-083-002-022G	SWP-D-C
67 12 8 377 987	246-083-002-015	246-083-002-022G	SWP-D-C
67 12 8 377 987	246-083-002-019	246-083-002-022G	SWP-D-C
67 12 8 377 987	246-083-002-022G		SWP-D-C



OE Nr.	Artikel Nr.	Artikel Nr. (neu)	Artikelbezeichnung
--------	-------------	-------------------	--------------------

CITROEN

0000643458	X10-729-002-007		SWP-M-C
------------	-----------------	--	---------

DAF

0616422	246-075-024-005C		SWP-M-G
0665345	246-082-003-001	246-082-008-012C	SWP-M-C
0665345	246-082-003-002	246-082-008-012C	SWP-M-C
0665345	246-082-003-004C	246-082-008-012C	SWP-M-C
0665345	246-082-003-009C	246-082-008-012C	SWP-M-C
0665345	246-082-008-005	246-082-008-012C	SWP-M-C
0665345	246-082-008-012C		SWP-M-C

FIAT

0046797755	246-083-001-001	246-083-001-004C	SWP-D-C
0046797755	246-083-001-004C		SWP-D-C
0071719636	246-083-001-001	246-083-001-004C	SWP-D-C
0071719636	246-083-001-004C		SWP-D-C

FORD

1652613	X10-729-002-004		SWP-M-C
6140949	X10-729-002-008		SWP-M-C
6153469	246-082-003-003	246-082-008-014C	SWP-M-C
6153469	246-082-003-005C	246-082-008-014C	SWP-M-C
6153469	246-082-003-007	246-082-008-014C	SWP-M-C
6153469	246-082-003-011	246-082-008-014C	SWP-M-C
6153469	246-082-003-016	246-082-008-014C	SWP-M-C
6153469	246-082-008-008	246-082-008-014C	SWP-M-C
6153469	246-082-008-009	246-082-008-014C	SWP-M-C
6153469	246-082-008-014C		SWP-M-C
6833495	X10-729-002-005		SWP-M-C
7003177	X10-729-002-005		SWP-M-C
7003178	X10-729-002-004		SWP-M-C
7222079	246-083-002-001Z	246-083-002-014G	SWP-D-C
7222079	246-083-002-007	246-083-002-014G	SWP-D-C
7222079	246-083-002-008	246-083-002-014G	SWP-D-C
7222079	246-083-002-012G	246-083-002-014G	SWP-D-C
7222079	246-083-002-014G		SWP-D-C
73PG-17K624-AA	246-075-021-003	246-075-023-004C	SWP-M-G
73PG-17K624-AA	246-075-023-003	246-075-023-004C	SWP-M-G
73PG-17K624-AA	246-075-023-004C		SWP-M-G
83BB-17K624-BA	X10-729-002-008		SWP-M-C
86VB-17K624-AA	246-075-042-001C		SWP-M-G
86VB-17K624-AA	246-082-003-003	246-082-008-014C	SWP-M-C
86VB-17K624-AA	246-082-003-005C	246-082-008-014C	SWP-M-C
86VB-17K624-AA	246-082-003-007	246-082-008-014C	SWP-M-C



OE Nr.	Artikel Nr.	Artikel Nr. (neu)	Artikelbezeichnung
--------	-------------	-------------------	--------------------

FORD

86VB-17K624-AA	246-082-003-011	246-082-008-014C	SWP-M-C
86VB-17K624-AA	246-082-003-013	246-075-042-001C	SWP-M-G
86VB-17K624-AA	246-082-003-016	246-082-008-014C	SWP-M-C
86VB-17K624-AA	246-082-008-008	246-082-008-014C	SWP-M-C
86VB-17K624-AA	246-082-008-009	246-082-008-014C	SWP-M-C
86VB-17K624-AA	246-082-008-014C		SWP-M-C
87AB-17K624-AC	X10-729-002-004		SWP-M-C
92AB-17K624-AA	X10-729-002-005		SWP-M-C
93BB-17K624-AA	X10-729-002-005		SWP-M-C
93BB-17K624-BA	X10-729-002-004		SWP-M-C
95VW-17K624-AA	246-083-002-001Z	246-083-002-014G	SWP-D-C
95VW-17K624-AA	246-083-002-007	246-083-002-014G	SWP-D-C
95VW-17K624-AA	246-083-002-008	246-083-002-014G	SWP-D-C
95VW-17K624-AA	246-083-002-012G	246-083-002-014G	SWP-D-C
95VW-17K624-AA	246-083-002-014G		SWP-D-C

IVECO

9 665 345	246-082-003-001	246-082-008-012C	SWP-M-C
9 665 345	246-082-003-002	246-082-008-012C	SWP-M-C
9 665 345	246-082-003-004C	246-082-008-012C	SWP-M-C
9 665 345	246-082-003-009C	246-082-008-012C	SWP-M-C
9 665 345	246-082-008-005	246-082-008-012C	SWP-M-C
9 665 345	246-082-008-012C		SWP-M-C

LADA

2108 5208009 20	246-082-003-003	246-082-008-014C	SWP-M-C
2108 5208009 20	246-082-003-005C	246-082-008-014C	SWP-M-C
2108 5208009 20	246-082-003-007	246-082-008-014C	SWP-M-C
2108 5208009 20	246-082-003-011	246-082-008-014C	SWP-M-C
2108 5208009 20	246-082-003-016	246-082-008-014C	SWP-M-C
2108 5208009 20	246-082-008-008	246-082-008-014C	SWP-M-C
2108 5208009 20	246-082-008-009	246-082-008-014C	SWP-M-C
2108 5208009 20	246-082-008-014C		SWP-M-C

LANCIA

0046797755	246-083-001-001	246-083-001-004C	SWP-D-C
0046797755	246-083-001-004C		SWP-D-C
0071719636	246-083-001-001	246-083-001-004C	SWP-D-C
0071719636	246-083-001-004C		SWP-D-C

MAN

81.26481-0033	89-602-050		G
81.26483-0001	88-326-001		C



OE Nr.	Artikel Nr.	Artikel Nr. (neu)	Artikelbezeichnung
--------	-------------	-------------------	--------------------

MAN

81.26484-0002	246-063-013-001D		V
81.26485-6008	246-075-010-001C		SWP-M-G
81.26485-6008	246-075-024-004	246-075-010-001C	SWP-M-G
81.26485-6016	246-082-003-001	246-082-008-012C	SWP-M-C
81.26485-6016	246-082-003-002	246-082-008-012C	SWP-M-C
81.26485-6016	246-082-003-004C	246-082-008-012C	SWP-M-C
81.26485-6016	246-082-003-009C	246-082-008-012C	SWP-M-C
81.26485-6016	246-082-008-005	246-082-008-012C	SWP-M-C
81.26485-6016	246-082-008-012C		SWP-M-C
81.26485-6027	246-083-001-002	246-083-002-006G	SWP-D-C
81.26485-6027	246-083-001-006C		SWP-D-C
81.26485-6027	246-083-002-002C	246-083-002-006G	SWP-D-C

MAZDA

1E00 76 672	X10-729-002-004		SWP-M-C
-------------	-----------------	--	---------

MERCEDES-BENZ

000 860 12 26	246-082-003-001	246-082-008-012C	SWP-M-C
000 860 12 26	246-082-003-002	246-082-008-012C	SWP-M-C
000 860 12 26	246-082-003-004C	246-082-008-012C	SWP-M-C
000 860 12 26	246-082-003-009C	246-082-008-012C	SWP-M-C
000 860 12 26	246-082-008-005	246-082-008-012C	SWP-M-C
000 860 12 26	246-082-008-012C		SWP-M-C
000 860 13 26	246-082-003-003	246-082-008-014C	SWP-M-C
000 860 13 26	246-082-003-005C	246-082-008-014C	SWP-M-C
000 860 13 26	246-082-003-007	246-082-008-014C	SWP-M-C
000 860 13 26	246-082-003-011	246-082-008-014C	SWP-M-C
000 860 13 26	246-082-003-016	246-082-008-014C	SWP-M-C
000 860 13 26	246-082-008-008	246-082-008-014C	SWP-M-C
000 860 13 26	246-082-008-009	246-082-008-014C	SWP-M-C
000 860 13 26	246-082-008-014C		SWP-M-C
000 860 15 26	246-075-050-007C		SWP-M-G
000 860 20 26	246-082-003-003	246-082-008-014C	SWP-M-C
000 860 20 26	246-082-003-005C	246-082-008-014C	SWP-M-C
000 860 20 26	246-082-003-007	246-082-008-014C	SWP-M-C
000 860 20 26	246-082-003-011	246-082-008-014C	SWP-M-C
000 860 20 26	246-082-003-016	246-082-008-014C	SWP-M-C
000 860 20 26	246-082-008-008	246-082-008-014C	SWP-M-C
000 860 20 26	246-082-008-009	246-082-008-014C	SWP-M-C
000 860 20 26			SWP-M-C
000 860 32 26	246-082-003-001	246-082-008-012C	SWP-M-C
000 860 32 26	246-082-003-002	246-082-008-012C	SWP-M-C
000 860 32 26	246-082-003-004C	246-082-008-012C	SWP-M-C
000 860 32 26	246-082-003-009C	246-082-008-012C	SWP-M-C
000 860 32 26	246-082-008-005	246-082-008-012C	SWP-M-C



OE Nr.	Artikel Nr.	Artikel Nr. (neu)	Artikelbezeichnung
MERCEDES-BENZ			
000 860 32 26	246-082-008-012C		SWP-M-C
000 860 33 26	246-082-003-003	246-082-008-014C	SWP-M-C
000 860 33 26	246-082-003-005C	246-082-008-014C	SWP-M-C
000 860 33 26	246-082-003-007	246-082-008-014C	SWP-M-C
000 860 33 26	246-082-003-011	246-082-008-014C	SWP-M-C
000 860 33 26	246-082-003-016	246-082-008-014C	SWP-M-C
000 860 33 26	246-082-008-008	246-082-008-014C	SWP-M-C
000 860 33 26	246-082-008-009	246-082-008-014C	SWP-M-C
000 860 33 26	246-082-008-014C		SWP-M-C
000 860 60 47	246-068-003-001G		N
000 869 01 58	88-205-001		C
000 869 10 22	246-063-004-001G		V
000 869 21 20	246-061-009-002D		R
000 869 22 21	246-075-015-001C		SWP-M-G
000 869 22 21	246-075-023-020	246-075-015-001C	SWP-M-G
000 869 24 21	246-075-010-001C		SWP-M-G
000 869 24 47	246-069-026-001G		N
000 869 29 21	246-075-021-004	246-075-021-007C	SWP-M-G
000 869 29 21	246-075-021-007C		SWP-M-G
000 869 30 21	246-075-017-001	246-075-017-002C	SWP-M-G
000 869 30 21	246-075-017-002C		SWP-M-G
000 869 30 21	246-075-021-004	246-075-021-007C	SWP-M-G
000 869 30 21	246-075-021-007C		SWP-M-G
000 869 31 21	246-075-024-002C		SWP-M-G
107 869 00 19	246-063-016-001G		V
107 869 00 24	88-326-004		C
108 869 01 21	246-075-017-001	246-075-017-002C	SWP-M-G
108 869 01 21	246-075-017-002C		SWP-M-G
115 860 01 69	246-063-016-003G		V
115 869 02 21	246-075-017-001	246-075-017-002C	SWP-M-G
115 869 02 21	246-075-017-002C		SWP-M-G
116 860 01 69	246-063-016-003A	246-063-016-003G	V
123 860 02 47	246-069-039-003G		N
124 860 02 47	246-069-039-001	246-069-039-003G	N
124 869 00 21	246-082-005-001	246-082-005-002C	SWP-M-C
124 869 00 21	246-082-005-002C		SWP-M-C
124 869 01 21	246-082-005-001	246-082-005-002C	SWP-M-C
124 869 01 21	246-082-005-002C		SWP-M-C
124 869 03 21	246-082-005-001	246-082-005-002C	SWP-M-C
124 869 03 21	246-082-005-002C		SWP-M-C
124 869 04 21	246-082-005-001	246-082-005-002C	SWP-M-C
124 869 04 21	246-082-005-002C		SWP-M-C
124 869 05 21	246-082-005-001	246-082-005-002C	SWP-M-C
124 869 05 21	246-082-005-002C		SWP-M-C
124 869 06 21	246-082-005-001	246-082-005-002C	SWP-M-C
124 869 06 21	246-082-005-002C		SWP-M-C
126 860 07 47	246-080-003-006D		N-H



OE Nr.	Artikel Nr.	Artikel Nr. (neu)	Artikelbezeichnung
--------	-------------	-------------------	--------------------

MERCEDES-BENZ

127 860 07 47	246-080-003-001	246-080-003-006D	N-H
140 869 02 21	246-082-008-013P		SWP-M-C
141 869 02 21	246-082-008-003	246-082-008-013P	SWP-M-C
142 869 02 21	246-082-008-011C	246-082-008-013P	SWP-M-C
202 869 00 21	246-082-008-013P		SWP-M-C
203 869 00 21	246-082-008-003	246-082-008-013P	SWP-M-C
204 869 00 21	246-082-008-011C	246-082-008-013P	SWP-M-C
210 869 08 21	246-082-008-015N	246-082-008-025G	SWP-M-C
210 869 08 21	246-082-008-017	246-082-008-025G	SWP-M-C
210 869 08 21	246-082-008-019	246-082-008-025G	SWP-M-C
210 869 08 21	246-082-008-022	246-082-008-025G	SWP-M-C
210 869 08 21	246-082-008-025G		SWP-M-C
210 869 08 21	246-082-008-026	246-082-008-025G	SWP-M-C
322 869 00 47	246-069-029-004G		N
608 869 00 14	246-063-004-001G		V

MITSUBISHI

MR911031	246-086-001-002C		HLWP
MR911031	246-086-001-005	246-086-001-002C	HLWP
MR911031	246-086-001-006	246-086-001-002C	HLWP

OPEL

90045820	246-082-003-003	246-082-008-014C	SWP-M-C
90045820	246-082-003-005C	246-082-008-014C	SWP-M-C
90045820	246-082-003-007	246-082-008-014C	SWP-M-C
90045820	246-082-003-011	246-082-008-014C	SWP-M-C
90045820	246-082-003-016	246-082-008-014C	SWP-M-C
90045820	246-082-008-008	246-082-008-014C	SWP-M-C
90045820	246-082-008-009	246-082-008-014C	SWP-M-C
90045820	246-082-008-014C		SWP-M-C
90226604	246-083-001-001	246-083-001-004C	SWP-D-C
90226604	246-083-001-004C		SWP-D-C
90585761	246-082-008-001Z	246-082-008-021G	SWP-M-C
90585761	246-082-008-018	246-082-008-021G	SWP-M-C
90585761	246-082-008-021G		SWP-M-C
90585762	246-083-002-001Z	246-083-002-014G	SWP-D-C
90585762	246-083-002-007	246-083-002-014G	SWP-D-C
90585762	246-083-002-008	246-083-002-014G	SWP-D-C
90585762	246-083-002-012G	246-083-002-014G	SWP-D-C
90585762	246-083-002-014G		SWP-D-C
14 50 156	246-082-003-003	246-082-008-014C	SWP-M-C
14 50 156	246-082-003-005C	246-082-008-014C	SWP-M-C
14 50 156	246-082-003-007	246-082-008-014C	SWP-M-C
14 50 156	246-082-003-011	246-082-008-014C	SWP-M-C
14 50 156	246-082-003-016	246-082-008-014C	SWP-M-C



OE Nr.	Artikel Nr.	Artikel Nr. (neu)	Artikelbezeichnung
--------	-------------	-------------------	--------------------

OPEL

14 50 156	246-082-008-008	246-082-008-014C	SWP-M-C
14 50 156	246-082-008-009	246-082-008-014C	SWP-M-C
14 50 156	246-082-008-014C		SWP-M-C
14 50 174	246-082-003-003	246-082-008-014C	SWP-M-C
14 50 174	246-082-003-005C	246-082-008-014C	SWP-M-C
14 50 174	246-082-003-007	246-082-008-014C	SWP-M-C
14 50 174	246-082-003-011	246-082-008-014C	SWP-M-C
14 50 174	246-082-003-016	246-082-008-014C	SWP-M-C
14 50 174	246-082-008-008	246-082-008-014C	SWP-M-C
14 50 174	246-082-008-009	246-082-008-014C	SWP-M-C
14 50 174	246-082-008-014C		SWP-M-C
14 50 175	246-083-001-001	246-083-001-004C	SWP-D-C
14 50 175	246-083-001-004C		SWP-D-C
14 50 184	246-082-008-001Z	246-082-008-021G	SWP-M-C
14 50 184	246-082-008-018	246-082-008-021G	SWP-M-C
14 50 184	246-082-008-021G		SWP-M-C
14 50 185	246-083-002-001Z	246-083-002-014G	SWP-D-C
14 50 185	246-083-002-007	246-083-002-014G	SWP-D-C
14 50 185	246-083-002-008	246-083-002-014G	SWP-D-C
14 50 185	246-083-002-012G	246-083-002-014G	SWP-D-C
14 50 185	246-083-002-014G		SWP-D-C

PEUGEOT

643458	X10-729-002-007		SWP-M-C
--------	-----------------	--	---------

PORSCHE

823 955 651	246-075-015-016C	246-075-021-006C	SWP-M-G
823 955 651	246-075-021-001	246-075-021-006C	SWP-M-G
823 955 651	246-075-021-006C		SWP-M-G
928.628.074.01	246-075-015-001C		SWP-M-G
928.628.172.01	246-075-042-001C		SWP-M-G
928.628.172.01	246-082-003-013	246-075-042-001C	SWP-M-G
996.624.502.00	246-086-001-002C		HLWP
996.624.502.00	246-086-001-005	246-086-001-002C	HLWP
996.624.502.00	246-086-001-006	246-086-001-002C	HLWP
996.628.172.00	246-082-008-015N	246-082-008-025G	SWP-M-C
996.628.172.00	246-082-008-017	246-082-008-025G	SWP-M-C
996.628.172.00	246-082-008-019	246-082-008-025G	SWP-M-C
996.628.172.00	246-082-008-022	246-082-008-025G	SWP-M-C
996.628.172.00	246-082-008-025G		SWP-M-C
996.628.172.00	246-082-008-026	246-082-008-025G	SWP-M-C

RENAULT

7700802336	X10-729-002-006		SWP-M-C
------------	-----------------	--	---------



OE Nr.	Artikel Nr.	Artikel Nr. (neu)	Artikelbezeichnung
--------	-------------	-------------------	--------------------

SAAB

8593477	246-082-003-003	246-082-008-014C	SWP-M-C
8593477	246-082-003-005C	246-082-008-014C	SWP-M-C
8593477	246-082-003-007	246-082-008-014C	SWP-M-C
8593477	246-082-003-011	246-082-008-014C	SWP-M-C
8593477	246-082-003-016	246-082-008-014C	SWP-M-C
8593477	246-082-008-008	246-082-008-014C	SWP-M-C
8593477	246-082-008-009	246-082-008-014C	SWP-M-C
8593477	246-082-008-014C		SWP-M-C
9506379	246-082-001-001C		SWP-M-C

SCANIA

295970	246-082-003-001	246-082-008-012C	SWP-M-C
295970	246-082-003-002	246-082-008-012C	SWP-M-C
295970	246-082-003-004C	246-082-008-012C	SWP-M-C
295970	246-082-003-009C	246-082-008-012C	SWP-M-C
295970	246-082-008-005	246-082-008-012C	SWP-M-C
295970	246-082-008-012C		SWP-M-C
300786	246-063-013-001D		V
300792	246-069-050-005D		N
353546	246-082-001-002C		SWP-M-C
367110	246-082-001-001C		SWP-M-C
1395994	246-075-044-003A		SWP-M-G

SEAT

191 955 985 A	246-069-056-001Z		N
191 955 986 A	246-080-010-002Z		N-H
1H5 955 651	246-082-008-001Z	246-082-008-021G	SWP-M-C
1H5 955 651	246-082-008-018	246-082-008-021G	SWP-M-C
1H5 955 651	246-082-008-021G		SWP-M-C
1H6 955 651	246-083-002-001Z	246-083-002-014G	SWP-D-C
1H6 955 651	246-083-002-007	246-083-002-014G	SWP-D-C
1H6 955 651	246-083-002-008	246-083-002-014G	SWP-D-C
1H6 955 651	246-083-002-012G	246-083-002-014G	SWP-D-C
1H6 955 651	246-083-002-014G		SWP-D-C
1J0 955 681	246-086-001-002C		HLWP
1J0 955 681	246-086-001-005	246-086-001-002C	HLWP
1J0 955 681	246-086-001-006	246-086-001-002C	HLWP
1J0 973 722 A	X11-246-003-014		A
1J5 955 651	246-082-008-015N	246-082-008-025G	SWP-M-C
1J5 955 651	246-082-008-017	246-082-008-025G	SWP-M-C
1J5 955 651	246-082-008-019	246-082-008-025G	SWP-M-C
1J5 955 651	246-082-008-022	246-082-008-025G	SWP-M-C
1J5 955 651	246-082-008-025G		SWP-M-C
1J5 955 651	246-082-008-026	246-082-008-025G	SWP-M-C
1J6 955 651	246-083-002-005C	246-083-002-022G	SWP-D-C



OE Nr.	Artikel Nr.	Artikel Nr. (neu)	Artikelbezeichnung
--------	-------------	-------------------	--------------------

SEAT

1J6 955 651	246-083-002-009	246-083-002-022G	SWP-D-C
1J6 955 651	246-083-002-010	246-083-002-022G	SWP-D-C
1J6 955 651	246-083-002-015	246-083-002-022G	SWP-D-C
1J6 955 651	246-083-002-019	246-083-002-022G	SWP-D-C
1J6 955 651	246-083-002-022G		SWP-D-C
1T0 955 651 A	246-083-002-005C	246-083-002-022G	SWP-D-C
1T0 955 651 A	246-083-002-009	246-083-002-022G	SWP-D-C
1T0 955 651 A	246-083-002-010	246-083-002-022G	SWP-D-C
1T0 955 651 A	246-083-002-015	246-083-002-022G	SWP-D-C
1T0 955 651 A	246-083-002-019	246-083-002-022G	SWP-D-C
1T0 955 651 A	246-083-002-022G		SWP-D-C
3B7 955 681	246-086-001-004	246-086-001-007C	HLWP
3B7 955 681	246-086-001-007C		HLWP
3B7 955 681	246-086-001-007C	246-086-001-007C	HLWP
3B7 955 681	246-086-001-016	246-086-001-007C	HLWP
431 955 651	246-082-003-003	246-082-008-014C	SWP-M-C
431 955 651	246-082-003-005C	246-082-008-014C	SWP-M-C
431 955 651	246-082-003-007	246-082-008-014C	SWP-M-C
431 955 651	246-082-003-011	246-082-008-014C	SWP-M-C
431 955 651	246-082-003-016	246-082-008-014C	SWP-M-C
431 955 651	246-082-008-008	246-082-008-014C	SWP-M-C
431 955 651	246-082-008-009	246-082-008-014C	SWP-M-C
431 955 651	246-082-008-014C		SWP-M-C

SKODA

1J0 955 681	246-086-001-002C		HLWP
1J0 955 681	246-086-001-005	246-086-001-002C	HLWP
1J0 955 681	246-086-001-006	246-086-001-002C	HLWP
1J0 973 722 A	X11-246-003-014		A
1J5 955 651	246-082-008-015N	246-082-008-025G	SWP-M-C
1J5 955 651	246-082-008-017	246-082-008-025G	SWP-M-C
1J5 955 651	246-082-008-019	246-082-008-025G	SWP-M-C
1J5 955 651	246-082-008-022	246-082-008-025G	SWP-M-C
1J5 955 651	246-082-008-025G		SWP-M-C
1J5 955 651	246-082-008-026	246-082-008-025G	SWP-M-C
1J6 955 651	246-083-002-005C	246-083-002-022G	SWP-D-C
1J6 955 651	246-083-002-009	246-083-002-022G	SWP-D-C
1J6 955 651	246-083-002-010	246-083-002-022G	SWP-D-C
1J6 955 651	246-083-002-015	246-083-002-022G	SWP-D-C
1J6 955 651	246-083-002-019	246-083-002-022G	SWP-D-C
1J6 955 651	246-083-002-022G		SWP-D-C
1T0 955 651	246-082-008-015N	246-082-008-025G	SWP-M-C
1T0 955 651	246-082-008-017	246-082-008-025G	SWP-M-C
1T0 955 651	246-082-008-019	246-082-008-025G	SWP-M-C
1T0 955 651	246-082-008-022	246-082-008-025G	SWP-M-C
1T0 955 651	246-082-008-025G		SWP-M-C



OE Nr.	Artikel Nr.	Artikel Nr. (neu)	Artikelbezeichnung
--------	-------------	-------------------	--------------------

SKODA

1T0 955 651	246-082-008-026	246-082-008-025G	SWP-M-C
1T0 955 651 A	246-083-002-005C	246-083-002-022G	SWP-D-C
1T0 955 651 A	246-083-002-009	246-083-002-022G	SWP-D-C
1T0 955 651 A	246-083-002-010	246-083-002-022G	SWP-D-C
1T0 955 651 A	246-083-002-015	246-083-002-022G	SWP-D-C
1T0 955 651 A	246-083-002-019	246-083-002-022G	SWP-D-C
1T0 955 651 A	246-083-002-022G		SWP-D-C
3B0 955 681 A	246-086-001-004	246-086-001-007C	HLWP
3B0 955 681 A	246-086-001-007C		HLWP
3B0 955 681 A	246-086-001-007C	246-086-001-007C	HLWP
3B0 955 681 A	246-086-001-016	246-086-001-007C	HLWP
3B7 955 681	246-086-001-004	246-086-001-007C	HLWP
3B7 955 681	246-086-001-007C		HLWP
3B7 955 681	246-086-001-007C	246-086-001-007C	HLWP
3B7 955 681	246-086-001-016	246-086-001-007C	HLWP

SMART (MCC)

0000038V001000000	246-083-002-005C	246-083-002-022G	SWP-D-C
0000038V001000000	246-083-002-009	246-083-002-022G	SWP-D-C
0000038V001000000	246-083-002-010	246-083-002-022G	SWP-D-C
0000038V001000000	246-083-002-015	246-083-002-022G	SWP-D-C
0000038V001000000	246-083-002-019	246-083-002-022G	SWP-D-C
0000038V001000000	246-083-002-022G		SWP-D-C
0001753V001000000	246-082-008-015N	246-082-008-025G	SWP-M-C
0001753V001000000	246-082-008-017	246-082-008-025G	SWP-M-C
0001753V001000000	246-082-008-019	246-082-008-025G	SWP-M-C
0001753V001000000	246-082-008-022	246-082-008-025G	SWP-M-C
0001753V001000000	246-082-008-025G		SWP-M-C
0001753V001000000	246-082-008-026	246-082-008-025G	SWP-M-C

VAUXHALL

90492357	246-083-001-001	246-083-001-004C	SWP-D-C
90492357	246-083-001-004C		SWP-D-C
90585761	246-082-008-001Z	246-082-008-021G	SWP-M-C
90585761	246-082-008-018	246-082-008-021G	SWP-M-C
90585761	246-082-008-021G		SWP-M-C
90585762	246-083-002-001Z	246-083-002-014G	SWP-D-C
90585762	246-083-002-007	246-083-002-014G	SWP-D-C
90585762	246-083-002-008	246-083-002-014G	SWP-D-C
90585762	246-083-002-012G	246-083-002-014G	SWP-D-C
90585762	246-083-002-014G		SWP-D-C
14 50 174	246-082-003-003	246-082-008-014C	SWP-M-C
14 50 174	246-082-003-005C	246-082-008-014C	SWP-M-C
14 50 174	246-082-003-007	246-082-008-014C	SWP-M-C
14 50 174	246-082-003-011	246-082-008-014C	SWP-M-C



OE Nr.	Artikel Nr.	Artikel Nr. (neu)	Artikelbezeichnung
--------	-------------	-------------------	--------------------

VAUXHALL

14 50 174	246-082-003-016	246-082-008-014C	SWP-M-C
14 50 174	246-082-008-008	246-082-008-014C	SWP-M-C
14 50 174	246-082-008-009	246-082-008-014C	SWP-M-C
14 50 174	246-082-008-014C		SWP-M-C
14 50 175	246-083-001-001	246-083-001-004C	SWP-D-C
14 50 175	246-083-001-004C		SWP-D-C
14 50 184	246-082-008-001Z	246-082-008-021G	SWP-M-C
14 50 184	246-082-008-018	246-082-008-021G	SWP-M-C
14 50 184	246-082-008-021G		SWP-M-C
14 50 185	246-083-002-001Z	246-083-002-014G	SWP-D-C
14 50 185	246-083-002-007	246-083-002-014G	SWP-D-C
14 50 185	246-083-002-008	246-083-002-014G	SWP-D-C
14 50 185	246-083-002-012G	246-083-002-014G	SWP-D-C
14 50 185	246-083-002-014G		SWP-D-C

VOLKSWAGEN

191 955 681	246-086-001-002C		HLWP
191 955 681	246-086-001-005	246-086-001-002C	HLWP
191 955 681	246-086-001-006	246-086-001-002C	HLWP
191 955 985 A	246-069-056-001Z		N
191 955 986 A	246-080-010-002Z		N-H
1H5 955 651	246-082-008-001Z	246-082-008-021G	SWP-M-C
1H5 955 651	246-082-008-018	246-082-008-021G	SWP-M-C
1H5 955 651	246-082-008-021G		SWP-M-C
1H6 955 651	246-083-002-001Z	246-083-002-014G	SWP-D-C
1H6 955 651	246-083-002-007	246-083-002-014G	SWP-D-C
1H6 955 651	246-083-002-008	246-083-002-014G	SWP-D-C
1H6 955 651	246-083-002-012G	246-083-002-014G	SWP-D-C
1H6 955 651	246-083-002-014G		SWP-D-C
1J0 973 722 A	X11-246-003-014		A
1J5 955 651	246-082-008-015N	246-082-008-025G	SWP-M-C
1J5 955 651	246-082-008-017	246-082-008-025G	SWP-M-C
1J5 955 651	246-082-008-019	246-082-008-025G	SWP-M-C
1J5 955 651	246-082-008-022	246-082-008-025G	SWP-M-C
1J5 955 651	246-082-008-025G		SWP-M-C
1J5 955 651	246-082-008-026	246-082-008-025G	SWP-M-C
1J6 955 651	246-083-002-005C	246-083-002-022G	SWP-D-C
1J6 955 651	246-083-002-009	246-083-002-022G	SWP-D-C
1J6 955 651	246-083-002-010	246-083-002-022G	SWP-D-C
1J6 955 651	246-083-002-015	246-083-002-022G	SWP-D-C
1J6 955 651	246-083-002-019	246-083-002-022G	SWP-D-C
1J6 955 651	246-083-002-022G		SWP-D-C
1T0 955 651	246-082-008-015N	246-082-008-025G	SWP-M-C
1T0 955 651	246-082-008-017	246-082-008-025G	SWP-M-C
1T0 955 651	246-082-008-019	246-082-008-025G	SWP-M-C
1T0 955 651	246-082-008-022	246-082-008-025G	SWP-M-C



OE Nr.	Artikel Nr.	Artikel Nr. (neu)	Artikelbezeichnung
--------	-------------	-------------------	--------------------

VOLKSWAGEN

1T0 955 651	246-082-008-025G		SWP-M-C
1T0 955 651	246-082-008-026	246-082-008-025G	SWP-M-C
1T0 955 651 A	246-083-002-005C	246-083-002-022G	SWP-D-C
1T0 955 651 A	246-083-002-009	246-083-002-022G	SWP-D-C
1T0 955 651 A	246-083-002-010	246-083-002-022G	SWP-D-C
1T0 955 651 A	246-083-002-015	246-083-002-022G	SWP-D-C
1T0 955 651 A	246-083-002-019	246-083-002-022G	SWP-D-C
1T0 955 651 A	246-083-002-022G	246-083-002-022G	SWP-D-C
333 955 651	246-083-001-002	246-083-002-006G	SWP-D-C
333 955 651	246-083-002-002C	246-083-002-006G	SWP-D-C
333 955 651	246-083-002-006G		SWP-D-C
3B0 955 681	246-086-001-002C		HLWP
3B0 955 681	246-086-001-005	246-086-001-002C	HLWP
3B0 955 681	246-086-001-006	246-086-001-002C	HLWP
3B0 955 681 A	246-086-001-004	246-086-001-007C	HLWP
3B0 955 681 A	246-086-001-007C		HLWP
3B0 955 681 A	246-086-001-007C	246-086-001-007C	HLWP
3B0 955 681 A	246-086-001-016	246-086-001-007C	HLWP
3B7 955 681	246-086-001-004	246-086-001-007C	HLWP
3B7 955 681	246-086-001-007C		HLWP
3B7 955 681	246-086-001-007C	246-086-001-007C	HLWP
3B7 955 681	246-086-001-016	246-086-001-007C	HLWP
431 955 651	246-082-003-003	246-082-008-014C	SWP-M-C
431 955 651	246-082-003-005C	246-082-008-014C	SWP-M-C
431 955 651	246-082-003-007	246-082-008-014C	SWP-M-C
431 955 651	246-082-003-011	246-082-008-014C	SWP-M-C
431 955 651	246-082-003-016	246-082-008-014C	SWP-M-C
431 955 651	246-082-008-008	246-082-008-014C	SWP-M-C
431 955 651	246-082-008-009	246-082-008-014C	SWP-M-C
431 955 651	246-082-008-014C		SWP-M-C
690 955 651	246-082-003-001	246-082-008-012C	SWP-M-C
690 955 651	246-082-003-002	246-082-008-012C	SWP-M-C
690 955 651	246-082-003-004C	246-082-008-012C	SWP-M-C
690 955 651	246-082-003-009C	246-082-008-012C	SWP-M-C
690 955 651	246-082-008-005	246-082-008-012C	SWP-M-C
690 955 651	246-082-008-012C		SWP-M-C
823 955 651	246-075-015-016C	246-075-021-006C	SWP-M-G
823 955 651	246-075-021-001	246-075-021-006C	SWP-M-G
823 955 651	246-075-021-006C		SWP-M-G

VOLVO

1254197	246-075-015-016C	246-075-021-006C	SWP-M-G
1254197	246-075-021-001	246-075-021-006C	SWP-M-G
1254197	246-075-021-006C		SWP-M-G
1258016	246-075-044-001C		SWP-M-G
1259832	246-075-044-002A		SWP-M-G



OE Nr.	Artikel Nr.	Artikel Nr. (neu)	Artikelbezeichnung
--------	-------------	-------------------	--------------------

VOLVO

1304783	246-075-051-002	246-075-051-003C	SWP-M-G
1304783	246-075-051-003C		SWP-M-G
1304784	246-075-051-002	246-075-051-003C	SWP-M-G
1304784	246-075-051-003C		SWP-M-G
1307159	246-068-013-004D		N
1307159	246-068-050-003D	246-068-013-004D	N
1342553	246-063-004-001G		V
1585878	246-075-040-020C		SWP-M-G
1606929	246-075-051-007C		SWP-M-G
3205207	246-075-042-001C		SWP-M-G
3205207	246-082-003-013	246-075-042-001C	SWP-M-G
3276564	246-075-021-003	246-075-023-004C	SWP-M-G
3276564	246-075-023-003	246-075-023-004C	SWP-M-G
3276564	246-075-023-004C		SWP-M-G
4831689	246-069-050-005D		N



Referenzliste

OE Nr. > Artikel Nr. (alle Hersteller)

OE Nr.	Hersteller	Artikel Nr.	Artikel Nr. (neu)	Artikelbezeichnung
00000000295970	SCANIA	246-082-003-001	246-082-008-012C	SWP-M-C
00000000295970	SCANIA	246-082-003-002	246-082-008-012C	SWP-M-C
00000000295970	SCANIA	246-082-003-004C	246-082-008-012C	SWP-M-C
00000000295970	SCANIA	246-082-003-009C	246-082-008-012C	SWP-M-C
00000000295970	SCANIA	246-082-008-005	246-082-008-012C	SWP-M-C
00000000295970	SCANIA	246-082-008-012C		SWP-M-C
300786	SCANIA	246-063-013-001D		V
300792	SCANIA	246-069-050-005D		N
353546	SCANIA	246-082-001-002C		SWP-M-C
367110	SCANIA	246-082-001-001C		SWP-M-C
0616422	DAF	246-075-024-005C		SWP-M-G
0000643458	CITROEN	X10-729-002-007		SWP-M-C
643458	PEUGEOT	X10-729-002-007		SWP-M-C
0665345	DAF	246-082-003-001	246-082-008-012C	SWP-M-C
0665345	DAF	246-082-003-002	246-082-008-012C	SWP-M-C
0665345	DAF	246-082-003-004C	246-082-008-012C	SWP-M-C
0665345	DAF	246-082-003-009C	246-082-008-012C	SWP-M-C
0665345	DAF	246-082-008-005	246-082-008-012C	SWP-M-C
0665345	DAF	246-082-008-012C		SWP-M-C
1254197	VOLVO	246-075-015-016C	246-075-021-006C	SWP-M-G
1254197	VOLVO	246-075-021-001	246-075-021-006C	SWP-M-G
1254197	VOLVO	246-075-021-006C		SWP-M-G
1258016	VOLVO	246-075-044-001C		SWP-M-G
1259832	VOLVO	246-075-044-002A		SWP-M-G
1304783	VOLVO	246-075-051-002	246-075-051-003C	SWP-M-G
1304783	VOLVO	246-075-051-003C		SWP-M-G
1304784	VOLVO	246-075-051-002	246-075-051-003C	SWP-M-G
1304784	VOLVO	246-075-051-003C		SWP-M-G
1307159	VOLVO	246-068-013-004D		N
1307159	VOLVO	246-068-050-003D	246-068-013-004D	N
1342553	VOLVO	246-063-004-001G		V
01395994	SCANIA	246-075-044-003A		SWP-M-G
1585878	VOLVO	246-075-040-020C		SWP-M-G
1606929	VOLVO	246-075-051-007C		SWP-M-G
1652613	FORD	X10-729-002-004		SWP-M-C
3205207	VOLVO	246-075-042-001C		SWP-M-G
3205207	VOLVO	246-082-003-013	246-075-042-001C	SWP-M-G
3276564	VOLVO	246-075-021-003	246-075-023-004C	SWP-M-G
3276564	VOLVO	246-075-023-003	246-075-023-004C	SWP-M-G
3276564	VOLVO	246-075-023-004C		SWP-M-G
4831689	VOLVO	246-069-050-005D		N
6140949	FORD	X10-729-002-008		SWP-M-C
6153469	FORD	246-082-003-003	246-082-008-014C	SWP-M-C
6153469	FORD	246-082-003-005C	246-082-008-014C	SWP-M-C



OE Nr.	Hersteller	Artikel Nr.	Artikel Nr. (neu)	Artikelbezeichnung
6153469	FORD	246-082-003-007	246-082-008-014C	SWP-M-C
6153469	FORD	246-082-003-011	246-082-008-014C	SWP-M-C
6153469	FORD	246-082-003-016	246-082-008-014C	SWP-M-C
6153469	FORD	246-082-008-008	246-082-008-014C	SWP-M-C
6153469	FORD	246-082-008-009	246-082-008-014C	SWP-M-C
6153469	FORD	246-082-008-014C		SWP-M-C
6833495	FORD	X10-729-002-005		SWP-M-C
7003177	FORD	X10-729-002-005		SWP-M-C
7003178	FORD	X10-729-002-004		SWP-M-C
7222079	FORD	246-083-002-001Z	246-083-002-014G	SWP-D-C
7222079	FORD	246-083-002-007	246-083-002-014G	SWP-D-C
7222079	FORD	246-083-002-008	246-083-002-014G	SWP-D-C
7222079	FORD	246-083-002-012G	246-083-002-014G	SWP-D-C
7222079	FORD	246-083-002-014G		SWP-D-C
8593477	SAAB	246-082-003-003	246-082-008-014C	SWP-M-C
8593477	SAAB	246-082-003-005C	246-082-008-014C	SWP-M-C
8593477	SAAB	246-082-003-007	246-082-008-014C	SWP-M-C
8593477	SAAB	246-082-003-011	246-082-008-014C	SWP-M-C
8593477	SAAB	246-082-003-016	246-082-008-014C	SWP-M-C
8593477	SAAB	246-082-008-008	246-082-008-014C	SWP-M-C
8593477	SAAB	246-082-008-009	246-082-008-014C	SWP-M-C
8593477	SAAB	246-082-008-014C		SWP-M-C
9506379	SAAB	246-082-001-001C		SWP-M-C
0046797755	ALFA ROMEO	246-083-001-001	246-083-001-004C	SWP-D-C
0046797755	ALFA ROMEO	246-083-001-004C		SWP-D-C
0046797755	FIAT	246-083-001-001	246-083-001-004C	SWP-D-C
0046797755	FIAT	246-083-001-004C		SWP-D-C
0046797755	LANCIA	246-083-001-001	246-083-001-004C	SWP-D-C
0046797755	LANCIA	246-083-001-004C		SWP-D-C
0071719636	ALFA ROMEO	246-083-001-001	246-083-001-004C	SWP-D-C
0071719636	ALFA ROMEO	246-083-001-004C		SWP-D-C
0071719636	FIAT	246-083-001-001	246-083-001-004C	SWP-D-C
0071719636	FIAT	246-083-001-004C		SWP-D-C
0071719636	LANCIA	246-083-001-001	246-083-001-004C	SWP-D-C
0071719636	LANCIA	246-083-001-004C		SWP-D-C
90045820	OPEL	246-082-003-003	246-082-008-014C	SWP-M-C
90045820	OPEL	246-082-003-005C	246-082-008-014C	SWP-M-C
90045820	OPEL	246-082-003-007	246-082-008-014C	SWP-M-C
90045820	OPEL	246-082-003-011	246-082-008-014C	SWP-M-C
90045820	OPEL	246-082-003-016	246-082-008-014C	SWP-M-C
90045820	OPEL	246-082-008-008	246-082-008-014C	SWP-M-C
90045820	OPEL	246-082-008-009	246-082-008-014C	SWP-M-C
90045820	OPEL	246-082-008-014C		SWP-M-C
90226604	OPEL	246-083-001-001	246-083-001-004C	SWP-D-C



OE Nr.	Hersteller	Artikel Nr.	Artikel Nr. (neu)	Artikelbezeichnung
90226604	OPEL	246-083-001-004C		SWP-D-C
90492357	VAUXHALL	246-083-001-001	246-083-001-004C	SWP-D-C
90492357	VAUXHALL	246-083-001-004C		SWP-D-C
90585761	OPEL	246-082-008-001Z	246-082-008-021G	SWP-M-C
90585761	OPEL	246-082-008-018	246-082-008-021G	SWP-M-C
90585761	OPEL	246-082-008-021G		SWP-M-C
90585761	VAUXHALL	246-082-008-001Z	246-082-008-021G	SWP-M-C
90585761	VAUXHALL	246-082-008-018	246-082-008-021G	SWP-M-C
90585761	VAUXHALL	246-082-008-021G		SWP-M-C
90585762	OPEL	246-083-002-001Z	246-083-002-014G	SWP-D-C
90585762	OPEL	246-083-002-007	246-083-002-014G	SWP-D-C
90585762	OPEL	246-083-002-008	246-083-002-014G	SWP-D-C
90585762	OPEL	246-083-002-012G	246-083-002-014G	SWP-D-C
90585762	OPEL	246-083-002-014G		SWP-D-C
90585762	VAUXHALL	246-083-002-001Z	246-083-002-014G	SWP-D-C
90585762	VAUXHALL	246-083-002-007	246-083-002-014G	SWP-D-C
90585762	VAUXHALL	246-083-002-008	246-083-002-014G	SWP-D-C
90585762	VAUXHALL	246-083-002-012G	246-083-002-014G	SWP-D-C
90585762	VAUXHALL	246-083-002-014G		SWP-D-C
7700802336	RENAULT	X10-729-002-006		SWP-M-C
000 860 12 26	MERCEDES-BENZ	246-082-003-001	246-082-008-012C	SWP-M-C
000 860 12 26	MERCEDES-BENZ	246-082-003-002	246-082-008-012C	SWP-M-C
000 860 12 26	MERCEDES-BENZ	246-082-003-004C	246-082-008-012C	SWP-M-C
000 860 12 26	MERCEDES-BENZ	246-082-003-009C	246-082-008-012C	SWP-M-C
000 860 12 26	MERCEDES-BENZ	246-082-008-005	246-082-008-012C	SWP-M-C
000 860 12 26	MERCEDES-BENZ	246-082-008-012C		SWP-M-C
000 860 13 26	MERCEDES-BENZ	246-082-003-003	246-082-008-014C	SWP-M-C
000 860 13 26	MERCEDES-BENZ	246-082-003-005C	246-082-008-014C	SWP-M-C
000 860 13 26	MERCEDES-BENZ	246-082-003-007	246-082-008-014C	SWP-M-C
000 860 13 26	MERCEDES-BENZ	246-082-003-011	246-082-008-014C	SWP-M-C
000 860 13 26	MERCEDES-BENZ	246-082-003-016	246-082-008-014C	SWP-M-C
000 860 13 26	MERCEDES-BENZ	246-082-008-008	246-082-008-014C	SWP-M-C
000 860 13 26	MERCEDES-BENZ	246-082-008-009	246-082-008-014C	SWP-M-C
000 860 13 26	MERCEDES-BENZ	246-082-008-014C		SWP-M-C
000 860 15 26	MERCEDES-BENZ	246-075-050-007C		SWP-M-G
000 860 20 26	MERCEDES-BENZ	246-082-003-003	246-082-008-014C	SWP-M-C
000 860 20 26	MERCEDES-BENZ	246-082-003-005C	246-082-008-014C	SWP-M-C
000 860 20 26	MERCEDES-BENZ	246-082-003-007	246-082-008-014C	SWP-M-C
000 860 20 26	MERCEDES-BENZ	246-082-003-011	246-082-008-014C	SWP-M-C
000 860 20 26	MERCEDES-BENZ	246-082-003-016	246-082-008-014C	SWP-M-C
000 860 20 26	MERCEDES-BENZ	246-082-008-008	246-082-008-014C	SWP-M-C
000 860 20 26	MERCEDES-BENZ	246-082-008-009	246-082-008-014C	SWP-M-C
000 860 20 26	MERCEDES-BENZ	246-082-008-014C		SWP-M-C
000 860 32 26	MERCEDES-BENZ	246-082-003-001	246-082-008-012C	SWP-M-C
000 860 32 26	MERCEDES-BENZ	246-082-003-002	246-082-008-012C	SWP-M-C
000 860 32 26	MERCEDES-BENZ	246-082-003-004C	246-082-008-012C	SWP-M-C
000 860 32 26	MERCEDES-BENZ	246-082-003-009C	246-082-008-012C	SWP-M-C
000 860 32 26	MERCEDES-BENZ	246-082-008-005	246-082-008-012C	SWP-M-C
000 860 32 26	MERCEDES-BENZ	246-082-008-012C		SWP-M-C



OE Nr.	Hersteller	Artikel Nr.	Artikel Nr. (neu)	Artikelbezeichnung
000 860 33 26	MERCEDES-BENZ	246-082-003-003	246-082-008-014C	SWP-M-C
000 860 33 26	MERCEDES-BENZ	246-082-003-005C	246-082-008-014C	SWP-M-C
000 860 33 26	MERCEDES-BENZ	246-082-003-007	246-082-008-014C	SWP-M-C
000 860 33 26	MERCEDES-BENZ	246-082-003-011	246-082-008-014C	SWP-M-C
000 860 33 26	MERCEDES-BENZ	246-082-003-016	246-082-008-014C	SWP-M-C
000 860 33 26	MERCEDES-BENZ	246-082-008-008	246-082-008-014C	SWP-M-C
000 860 33 26	MERCEDES-BENZ	246-082-008-009	246-082-008-014C	SWP-M-C
000 860 33 26	MERCEDES-BENZ	246-082-008-014C		SWP-M-C
000 860 60 47	MERCEDES-BENZ	246-068-003-001G		N
000 869 01 58	MERCEDES-BENZ	88-205-001		C
000 869 10 22	MERCEDES-BENZ	246-063-004-001G		V
000 869 21 20	MERCEDES-BENZ	246-061-009-002D		R
000 869 22 21	MERCEDES-BENZ	246-075-015-001C		SWP-M-G
000 869 22 21	MERCEDES-BENZ	246-075-023-020	246-075-015-001C	SWP-M-G
000 869 24 21	MERCEDES-BENZ	246-075-010-001C		SWP-M-G
000 869 24 47	MERCEDES-BENZ	246-069-026-001G		N
000 869 29 21	MERCEDES-BENZ	246-075-021-004	246-075-021-007C	SWP-M-G
000 869 29 21	MERCEDES-BENZ	246-075-021-007C		SWP-M-G
000 869 30 21	MERCEDES-BENZ	246-075-017-001	246-075-017-002C	SWP-M-G
000 869 30 21	MERCEDES-BENZ	246-075-017-002C		SWP-M-G
000 869 30 21	MERCEDES-BENZ	246-075-021-004	246-075-021-007C	SWP-M-G
000 869 30 21	MERCEDES-BENZ	246-075-021-007C		SWP-M-G
000 869 31 21	MERCEDES-BENZ	246-075-024-002C		SWP-M-G
608 869 00 14	MERCEDES-BENZ	246-063-004-001G		V
0000038V001000000	SMART (MCC)	246-083-002-005C	246-083-002-022G	SWP-D-C
0000038V001000000	SMART (MCC)	246-083-002-009	246-083-002-022G	SWP-D-C
0000038V001000000	SMART (MCC)	246-083-002-010	246-083-002-022G	SWP-D-C
0000038V001000000	SMART (MCC)	246-083-002-015	246-083-002-022G	SWP-D-C
0000038V001000000	SMART (MCC)	246-083-002-019	246-083-002-022G	SWP-D-C
0000038V001000000	SMART (MCC)	246-083-002-022G		SWP-D-C
0001753V001000000	SMART (MCC)	246-082-008-015N	246-082-008-025G	SWP-M-C
0001753V001000000	SMART (MCC)	246-082-008-017	246-082-008-025G	SWP-M-C
0001753V001000000	SMART (MCC)	246-082-008-019	246-082-008-025G	SWP-M-C
0001753V001000000	SMART (MCC)	246-082-008-022	246-082-008-025G	SWP-M-C
0001753V001000000	SMART (MCC)	246-082-008-025G		SWP-M-C
0001753V001000000	SMART (MCC)	246-082-008-026	246-082-008-025G	SWP-M-C
107 869 00 19	MERCEDES-BENZ	246-063-016-001G		V
107 869 00 24	MERCEDES-BENZ	88-326-004		C
108 869 01 21	MERCEDES-BENZ	246-075-017-001	246-075-017-002C	SWP-M-G
108 869 01 21	MERCEDES-BENZ	246-075-017-002C		SWP-M-G
115 860 01 69	MERCEDES-BENZ	246-063-016-003G		V
115 869 02 21	MERCEDES-BENZ	246-075-017-001	246-075-017-002C	SWP-M-G
115 869 02 21	MERCEDES-BENZ	246-075-017-002C		SWP-M-G
116 860 01 69	MERCEDES-BENZ	246-063-016-003A	246-063-016-003G	V
123 860 02 47	MERCEDES-BENZ	246-069-039-003G		N
124 860 02 47	MERCEDES-BENZ	246-069-039-001	246-069-039-003G	N
124 869 00 21	MERCEDES-BENZ	246-082-005-001	246-082-005-002C	SWP-M-C
124 869 00 21	MERCEDES-BENZ	246-082-005-002C		SWP-M-C
124 869 01 21	MERCEDES-BENZ	246-082-005-001	246-082-005-002C	SWP-M-C



OE Nr.	Hersteller	Artikel Nr.	Artikel Nr. (neu)	Artikelbezeichnung
124 869 01 21	MERCEDES-BENZ	246-082-005-002C		SWP-M-C
124 869 03 21	MERCEDES-BENZ	246-082-005-001	246-082-005-002C	SWP-M-C
124 869 03 21	MERCEDES-BENZ	246-082-005-002C		SWP-M-C
124 869 04 21	MERCEDES-BENZ	246-082-005-001	246-082-005-002C	SWP-M-C
124 869 04 21	MERCEDES-BENZ	246-082-005-002C		SWP-M-C
124 869 05 21	MERCEDES-BENZ	246-082-005-001	246-082-005-002C	SWP-M-C
124 869 05 21	MERCEDES-BENZ	246-082-005-002C		SWP-M-C
124 869 06 21	MERCEDES-BENZ	246-082-005-001	246-082-005-002C	SWP-M-C
124 869 06 21	MERCEDES-BENZ	246-082-005-002C		SWP-M-C
126 860 07 47	MERCEDES-BENZ	246-080-003-006D		N-H
127 860 07 47	MERCEDES-BENZ	246-080-003-001	246-080-003-006D	N-H
14 50 156	OPEL	246-082-003-003	246-082-008-014C	SWP-M-C
14 50 156	OPEL	246-082-003-005C	246-082-008-014C	SWP-M-C
14 50 156	OPEL	246-082-003-007	246-082-008-014C	SWP-M-C
14 50 156	OPEL	246-082-003-011	246-082-008-014C	SWP-M-C
14 50 156	OPEL	246-082-003-016	246-082-008-014C	SWP-M-C
14 50 156	OPEL	246-082-008-008	246-082-008-014C	SWP-M-C
14 50 156	OPEL	246-082-008-009	246-082-008-014C	SWP-M-C
14 50 156	OPEL	246-082-008-014C		SWP-M-C
14 50 174	OPEL	246-082-003-003	246-082-008-014C	SWP-M-C
14 50 174	OPEL	246-082-003-005C	246-082-008-014C	SWP-M-C
14 50 174	OPEL	246-082-003-007	246-082-008-014C	SWP-M-C
14 50 174	OPEL	246-082-003-011	246-082-008-014C	SWP-M-C
14 50 174	OPEL	246-082-003-016	246-082-008-014C	SWP-M-C
14 50 174	OPEL	246-082-008-008	246-082-008-014C	SWP-M-C
14 50 174	OPEL	246-082-008-009	246-082-008-014C	SWP-M-C
14 50 174	OPEL	246-082-008-014C		SWP-M-C
14 50 174	VAUXHALL	246-082-003-003	246-082-008-014C	SWP-M-C
14 50 174	VAUXHALL	246-082-003-005C	246-082-008-014C	SWP-M-C
14 50 174	VAUXHALL	246-082-003-007	246-082-008-014C	SWP-M-C
14 50 174	VAUXHALL	246-082-003-011	246-082-008-014C	SWP-M-C
14 50 174	VAUXHALL	246-082-003-016	246-082-008-014C	SWP-M-C
14 50 174	VAUXHALL	246-082-008-008	246-082-008-014C	SWP-M-C
14 50 174	VAUXHALL	246-082-008-009	246-082-008-014C	SWP-M-C
14 50 174	VAUXHALL	246-082-008-014C		SWP-M-C
14 50 175	OPEL	246-083-001-001	246-083-001-004C	SWP-D-C
14 50 175	OPEL	246-083-001-004C		SWP-D-C
14 50 175	VAUXHALL	246-083-001-001	246-083-001-004C	SWP-D-C
14 50 175	VAUXHALL	246-083-001-004C		SWP-D-C
14 50 184	OPEL	246-082-008-001Z	246-082-008-021G	SWP-M-C
14 50 184	OPEL	246-082-008-018	246-082-008-021G	SWP-M-C
14 50 184	OPEL	246-082-008-021G		SWP-M-C
14 50 184	VAUXHALL	246-082-008-001Z	246-082-008-021G	SWP-M-C
14 50 184	VAUXHALL	246-082-008-018	246-082-008-021G	SWP-M-C
14 50 184	VAUXHALL	246-082-008-021G		SWP-M-C
14 50 185	OPEL	246-083-002-001Z	246-083-002-014G	SWP-D-C
14 50 185	OPEL	246-083-002-007	246-083-002-014G	SWP-D-C
14 50 185	OPEL	246-083-002-008	246-083-002-014G	SWP-D-C
14 50 185	OPEL	246-083-002-012G	246-083-002-014G	SWP-D-C



OE Nr.	Hersteller	Artikel Nr.	Artikel Nr. (neu)	Artikelbezeichnung
14 50 185	OPEL	246-083-002-014G		SWP-D-C
14 50 185	VAUXHALL	246-083-002-001Z	246-083-002-014G	SWP-D-C
14 50 185	VAUXHALL	246-083-002-007	246-083-002-014G	SWP-D-C
14 50 185	VAUXHALL	246-083-002-008	246-083-002-014G	SWP-D-C
14 50 185	VAUXHALL	246-083-002-012G	246-083-002-014G	SWP-D-C
14 50 185	VAUXHALL	246-083-002-014G		SWP-D-C
140 869 02 21	MERCEDES-BENZ	246-082-008-013P		SWP-M-C
141 869 02 21	MERCEDES-BENZ	246-082-008-003	246-082-008-013P	SWP-M-C
142 869 02 21	MERCEDES-BENZ	246-082-008-011C	246-082-008-013P	SWP-M-C
191 955 681	VOLKSWAGEN	246-086-001-002C		HLWP
191 955 681	VOLKSWAGEN	246-086-001-005	246-086-001-002C	HLWP
191 955 681	VOLKSWAGEN	246-086-001-006	246-086-001-002C	HLWP
191 955 985 A	SEAT	246-069-056-001Z		N
191 955 985 A	VOLKSWAGEN	246-069-056-001Z		N
191 955 986 A	SEAT	246-080-010-002Z		N-H
191 955 986 A	VOLKSWAGEN	246-080-010-002Z		N-H
1E00 76 672	MAZDA	X10-729-002-004		SWP-M-C
1H5 955 651	SEAT	246-082-008-001Z	246-082-008-021G	SWP-M-C
1H5 955 651	SEAT	246-082-008-018	246-082-008-021G	SWP-M-C
1H5 955 651	SEAT	246-082-008-021G		SWP-M-C
1H5 955 651	VOLKSWAGEN	246-082-008-001Z	246-082-008-021G	SWP-M-C
1H5 955 651	VOLKSWAGEN	246-082-008-018	246-082-008-021G	SWP-M-C
1H5 955 651	VOLKSWAGEN	246-082-008-021G		SWP-M-C
1H6 955 651	SEAT	246-083-002-001Z	246-083-002-014G	SWP-D-C
1H6 955 651	SEAT	246-083-002-007	246-083-002-014G	SWP-D-C
1H6 955 651	SEAT	246-083-002-008	246-083-002-014G	SWP-D-C
1H6 955 651	SEAT	246-083-002-012G	246-083-002-014G	SWP-D-C
1H6 955 651	SEAT	246-083-002-014G		SWP-D-C
1H6 955 651	VOLKSWAGEN	246-083-002-001Z	246-083-002-014G	SWP-D-C
1H6 955 651	VOLKSWAGEN	246-083-002-007	246-083-002-014G	SWP-D-C
1H6 955 651	VOLKSWAGEN	246-083-002-008	246-083-002-014G	SWP-D-C
1H6 955 651	VOLKSWAGEN	246-083-002-012G	246-083-002-014G	SWP-D-C
1H6 955 651	VOLKSWAGEN	246-083-002-014G		SWP-D-C
1J0 955 681	AUDI	246-086-001-005	246-086-001-002C	HLWP
1J0 955 681	AUDI	246-086-001-006	246-086-001-002C	HLWP
1J0 955 681	SEAT	246-086-001-002C		HLWP
1J0 955 681	SEAT	246-086-001-005	246-086-001-002C	HLWP
1J0 955 681	SEAT	246-086-001-006	246-086-001-002C	HLWP
1J0 955 681	SKODA	246-086-001-002C		HLWP
1J0 955 681	SKODA	246-086-001-005	246-086-001-002C	HLWP
1J0 955 681	SKODA	246-086-001-006	246-086-001-002C	HLWP
1J0 973 722 A	AUDI	X11-246-003-014		A
1J0 973 722 A	SEAT	X11-246-003-014		A
1J0 973 722 A	SKODA	X11-246-003-014		A
1J0 973 722 A	VOLKSWAGEN	X11-246-003-014		A
1J5 955 651	AUDI	246-082-008-015N	246-082-008-025G	SWP-M-C
1J5 955 651	AUDI	246-082-008-017	246-082-008-025G	SWP-M-C
1J5 955 651	AUDI	246-082-008-019	246-082-008-025G	SWP-M-C
1J5 955 651	AUDI	246-082-008-022	246-082-008-025G	SWP-M-C



OE Nr.	Hersteller	Artikel Nr.	Artikel Nr. (neu)	Artikelbezeichnung
1J5 955 651	AUDI	246-082-008-025G		SWP-M-C
1J5 955 651	AUDI	246-082-008-026	246-082-008-025G	SWP-M-C
1J5 955 651	SEAT	246-082-008-015N	246-082-008-025G	SWP-M-C
1J5 955 651	SEAT	246-082-008-017	246-082-008-025G	SWP-M-C
1J5 955 651	SEAT	246-082-008-019	246-082-008-025G	SWP-M-C
1J5 955 651	SEAT	246-082-008-022	246-082-008-025G	SWP-M-C
1J5 955 651	SEAT	246-082-008-025G		SWP-M-C
1J5 955 651	SEAT	246-082-008-026	246-082-008-025G	SWP-M-C
1J5 955 651	SKODA	246-082-008-015N	246-082-008-025G	SWP-M-C
1J5 955 651	SKODA	246-082-008-017	246-082-008-025G	SWP-M-C
1J5 955 651	SKODA	246-082-008-019	246-082-008-025G	SWP-M-C
1J5 955 651	SKODA	246-082-008-022	246-082-008-025G	SWP-M-C
1J5 955 651	SKODA	246-082-008-025G		SWP-M-C
1J5 955 651	SKODA	246-082-008-026	246-082-008-025G	SWP-M-C
1J5 955 651	VOLKSWAGEN	246-082-008-015N	246-082-008-025G	SWP-M-C
1J5 955 651	VOLKSWAGEN	246-082-008-017	246-082-008-025G	SWP-M-C
1J5 955 651	VOLKSWAGEN	246-082-008-019	246-082-008-025G	SWP-M-C
1J5 955 651	VOLKSWAGEN	246-082-008-022	246-082-008-025G	SWP-M-C
1J5 955 651	VOLKSWAGEN	246-082-008-025G		SWP-M-C
1J5 955 651	VOLKSWAGEN	246-082-008-026	246-082-008-025G	SWP-M-C
1J6 955 651	AUDI	246-083-002-005C	246-083-002-022G	SWP-D-C
1J6 955 651	AUDI	246-083-002-009	246-083-002-022G	SWP-D-C
1J6 955 651	AUDI	246-083-002-010	246-083-002-022G	SWP-D-C
1J6 955 651	AUDI	246-083-002-015	246-083-002-022G	SWP-D-C
1J6 955 651	AUDI	246-083-002-019	246-083-002-022G	SWP-D-C
1J6 955 651	AUDI	246-083-002-022G		SWP-D-C
1J6 955 651	SEAT	246-083-002-005C	246-083-002-022G	SWP-D-C
1J6 955 651	SEAT	246-083-002-009	246-083-002-022G	SWP-D-C
1J6 955 651	SEAT	246-083-002-010	246-083-002-022G	SWP-D-C
1J6 955 651	SEAT	246-083-002-015	246-083-002-022G	SWP-D-C
1J6 955 651	SEAT	246-083-002-019	246-083-002-022G	SWP-D-C
1J6 955 651	SEAT	246-083-002-022G		SWP-D-C
1J6 955 651	SKODA	246-083-002-005C	246-083-002-022G	SWP-D-C
1J6 955 651	SKODA	246-083-002-009	246-083-002-022G	SWP-D-C
1J6 955 651	SKODA	246-083-002-010	246-083-002-022G	SWP-D-C
1J6 955 651	SKODA	246-083-002-015	246-083-002-022G	SWP-D-C
1J6 955 651	SKODA	246-083-002-019	246-083-002-022G	SWP-D-C
1J6 955 651	SKODA	246-083-002-022G		SWP-D-C
1J6 955 651	VOLKSWAGEN	246-083-002-005C	246-083-002-022G	SWP-D-C
1J6 955 651	VOLKSWAGEN	246-083-002-009	246-083-002-022G	SWP-D-C
1J6 955 651	VOLKSWAGEN	246-083-002-010	246-083-002-022G	SWP-D-C
1J6 955 651	VOLKSWAGEN	246-083-002-015	246-083-002-022G	SWP-D-C
1J6 955 651	VOLKSWAGEN	246-083-002-019	246-083-002-022G	SWP-D-C
1J6 955 651	VOLKSWAGEN	246-083-002-022G		SWP-D-C
1T0 955 651	SKODA	246-082-008-015N	246-082-008-025G	SWP-M-C
1T0 955 651	SKODA	246-082-008-017	246-082-008-025G	SWP-M-C
1T0 955 651	SKODA	246-082-008-019	246-082-008-025G	SWP-M-C
1T0 955 651	SKODA	246-082-008-022	246-082-008-025G	SWP-M-C
1T0 955 651	SKODA	246-082-008-025G		SWP-M-C



OE Nr.	Hersteller	Artikel Nr.	Artikel Nr. (neu)	Artikelbezeichnung
1T0 955 651	SKODA	246-082-008-026	246-082-008-025G	SWP-M-C
1T0 955 651	VOLKSWAGEN	246-082-008-015N	246-082-008-025G	SWP-M-C
1T0 955 651	VOLKSWAGEN	246-082-008-017	246-082-008-025G	SWP-M-C
1T0 955 651	VOLKSWAGEN	246-082-008-019	246-082-008-025G	SWP-M-C
1T0 955 651	VOLKSWAGEN	246-082-008-022	246-082-008-025G	SWP-M-C
1T0 955 651	VOLKSWAGEN	246-082-008-025G		SWP-M-C
1T0 955 651	VOLKSWAGEN	246-082-008-026	246-082-008-025G	SWP-M-C
1T0 955 651 A	AUDI	246-083-002-005C	246-083-002-022G	SWP-D-C
1T0 955 651 A	AUDI	246-083-002-009	246-083-002-022G	SWP-D-C
1T0 955 651 A	AUDI	246-083-002-010	246-083-002-022G	SWP-D-C
1T0 955 651 A	AUDI	246-083-002-015	246-083-002-022G	SWP-D-C
1T0 955 651 A	AUDI	246-083-002-019	246-083-002-022G	SWP-D-C
1T0 955 651 A	AUDI	246-083-002-022G		SWP-D-C
1T0 955 651 A	SEAT	246-083-002-005C	246-083-002-022G	SWP-D-C
1T0 955 651 A	SEAT	246-083-002-009	246-083-002-022G	SWP-D-C
1T0 955 651 A	SEAT	246-083-002-010	246-083-002-022G	SWP-D-C
1T0 955 651 A	SEAT	246-083-002-015	246-083-002-022G	SWP-D-C
1T0 955 651 A	SEAT	246-083-002-019	246-083-002-022G	SWP-D-C
1T0 955 651 A	SEAT	246-083-002-022G		SWP-D-C
1T0 955 651 A	SKODA	246-083-002-005C	246-083-002-022G	SWP-D-C
1T0 955 651 A	SKODA	246-083-002-009	246-083-002-022G	SWP-D-C
1T0 955 651 A	SKODA	246-083-002-010	246-083-002-022G	SWP-D-C
1T0 955 651 A	SKODA	246-083-002-015	246-083-002-022G	SWP-D-C
1T0 955 651 A	SKODA	246-083-002-019	246-083-002-022G	SWP-D-C
1T0 955 651 A	SKODA	246-083-002-022G		SWP-D-C
1T0 955 651 A	VOLKSWAGEN	246-083-002-005C	246-083-002-022G	SWP-D-C
1T0 955 651 A	VOLKSWAGEN	246-083-002-009	246-083-002-022G	SWP-D-C
1T0 955 651 A	VOLKSWAGEN	246-083-002-010	246-083-002-022G	SWP-D-C
1T0 955 651 A	VOLKSWAGEN	246-083-002-015	246-083-002-022G	SWP-D-C
1T0 955 651 A	VOLKSWAGEN	246-083-002-019	246-083-002-022G	SWP-D-C
1T0 955 651 A	VOLKSWAGEN	246-083-002-022G	246-083-002-022G	SWP-D-C
202 869 00 21	MERCEDES-BENZ	246-082-008-013P		SWP-M-C
203 869 00 21	MERCEDES-BENZ	246-082-008-003	246-082-008-013P	SWP-M-C
204 869 00 21	MERCEDES-BENZ	246-082-008-011C	246-082-008-013P	SWP-M-C
210 869 08 21	MERCEDES-BENZ	246-082-008-015N	246-082-008-025G	SWP-M-C
210 869 08 21	MERCEDES-BENZ	246-082-008-017	246-082-008-025G	SWP-M-C
210 869 08 21	MERCEDES-BENZ	246-082-008-019	246-082-008-025G	SWP-M-C
210 869 08 21	MERCEDES-BENZ	246-082-008-022	246-082-008-025G	SWP-M-C
210 869 08 21	MERCEDES-BENZ	246-082-008-025G		SWP-M-C
210 869 08 21	MERCEDES-BENZ	246-082-008-026	246-082-008-025G	SWP-M-C
2108 5208009 20	LADA	246-082-003-003	246-082-008-014C	SWP-M-C
2108 5208009 20	LADA	246-082-003-005C	246-082-008-014C	SWP-M-C
2108 5208009 20	LADA	246-082-003-007	246-082-008-014C	SWP-M-C
2108 5208009 20	LADA	246-082-003-011	246-082-008-014C	SWP-M-C
2108 5208009 20	LADA	246-082-003-016	246-082-008-014C	SWP-M-C
2108 5208009 20	LADA	246-082-008-008	246-082-008-014C	SWP-M-C
2108 5208009 20	LADA	246-082-008-009	246-082-008-014C	SWP-M-C
2108 5208009 20	LADA	246-082-008-014C		SWP-M-C
322 869 00 47	MERCEDES-BENZ	246-069-029-004G		N



OE Nr.	Hersteller	Artikel Nr.	Artikel Nr. (neu)	Artikelbezeichnung
333 955 651	VOLKSWAGEN	246-083-001-002	246-083-002-006G	SWP-D-C
333 955 651	VOLKSWAGEN	246-083-002-002C	246-083-002-006G	SWP-D-C
333 955 651	VOLKSWAGEN	246-083-002-006G		SWP-D-C
3B0 955 681	VOLKSWAGEN	246-086-001-002C		HLWP
3B0 955 681	VOLKSWAGEN	246-086-001-005	246-086-001-002C	HLWP
3B0 955 681	VOLKSWAGEN	246-086-001-006	246-086-001-002C	HLWP
3B0 955 681 A	SKODA	246-086-001-004	246-086-001-007C	HLWP
3B0 955 681 A	SKODA	246-086-001-007C		HLWP
3B0 955 681 A	SKODA	246-086-001-007C	246-086-001-007C	HLWP
3B0 955 681 A	SKODA	246-086-001-016	246-086-001-007C	HLWP
3B0 955 681 A	VOLKSWAGEN	246-086-001-004	246-086-001-007C	HLWP
3B0 955 681 A	VOLKSWAGEN	246-086-001-007C		HLWP
3B0 955 681 A	VOLKSWAGEN	246-086-001-007C	246-086-001-007C	HLWP
3B0 955 681 A	VOLKSWAGEN	246-086-001-016	246-086-001-007C	HLWP
3B7 955 681	AUDI	246-086-001-004	246-086-001-007C	HLWP
3B7 955 681	AUDI	246-086-001-007C		HLWP
3B7 955 681	AUDI	246-086-001-016	246-086-001-007C	HLWP
3B7 955 681	SEAT	246-086-001-004	246-086-001-007C	HLWP
3B7 955 681	SEAT	246-086-001-007C		HLWP
3B7 955 681	SEAT	246-086-001-007C	246-086-001-007C	HLWP
3B7 955 681	SEAT	246-086-001-016	246-086-001-007C	HLWP
3B7 955 681	SKODA	246-086-001-004	246-086-001-007C	HLWP
3B7 955 681	SKODA	246-086-001-007C		HLWP
3B7 955 681	SKODA	246-086-001-007C	246-086-001-007C	HLWP
3B7 955 681	SKODA	246-086-001-016	246-086-001-007C	HLWP
3B7 955 681	VOLKSWAGEN	246-086-001-004	246-086-001-007C	HLWP
3B7 955 681	VOLKSWAGEN	246-086-001-007C		HLWP
3B7 955 681	VOLKSWAGEN	246-086-001-007C	246-086-001-007C	HLWP
3B7 955 681	VOLKSWAGEN	246-086-001-016	246-086-001-007C	HLWP
431 955 651	AUDI	246-082-003-003	246-082-008-014C	SWP-M-C
431 955 651	AUDI	246-082-003-005C	246-082-008-014C	SWP-M-C
431 955 651	AUDI	246-082-003-007	246-082-008-014C	SWP-M-C
431 955 651	AUDI	246-082-003-011	246-082-008-014C	SWP-M-C
431 955 651	AUDI	246-082-003-016	246-082-008-014C	SWP-M-C
431 955 651	AUDI	246-082-008-008	246-082-008-014C	SWP-M-C
431 955 651	AUDI	246-082-008-009	246-082-008-014C	SWP-M-C
431 955 651	AUDI	246-082-008-014C		SWP-M-C
431 955 651	SEAT	246-082-003-003	246-082-008-014C	SWP-M-C
431 955 651	SEAT	246-082-003-005C	246-082-008-014C	SWP-M-C
431 955 651	SEAT	246-082-003-007	246-082-008-014C	SWP-M-C
431 955 651	SEAT	246-082-003-011	246-082-008-014C	SWP-M-C
431 955 651	SEAT	246-082-003-016	246-082-008-014C	SWP-M-C
431 955 651	SEAT	246-082-008-008	246-082-008-014C	SWP-M-C
431 955 651	SEAT	246-082-008-009	246-082-008-014C	SWP-M-C
431 955 651	SEAT	246-082-008-014C		SWP-M-C
431 955 651	VOLKSWAGEN	246-082-003-003	246-082-008-014C	SWP-M-C
431 955 651	VOLKSWAGEN	246-082-003-005C	246-082-008-014C	SWP-M-C
431 955 651	VOLKSWAGEN	246-082-003-007	246-082-008-014C	SWP-M-C
431 955 651	VOLKSWAGEN	246-082-003-011	246-082-008-014C	SWP-M-C



OE Nr.	Hersteller	Artikel Nr.	Artikel Nr. (neu)	Artikelbezeichnung
431 955 651	VOLKSWAGEN	246-082-003-016	246-082-008-014C	SWP-M-C
431 955 651	VOLKSWAGEN	246-082-008-008	246-082-008-014C	SWP-M-C
431 955 651	VOLKSWAGEN	246-082-008-009	246-082-008-014C	SWP-M-C
431 955 651	VOLKSWAGEN	246-082-008-014C		SWP-M-C
61 31 1 369 263	BMW	395-060-017-001C		FLS
61 66 1 350 885	BMW	88-326-001		C
61 66 1 355 299	BMW	246-063-013-001D		V
61 66 1 368 549	BMW	246-075-042-001C		SWP-M-G
61 66 1 368 549	BMW	246-082-003-013	246-075-042-001C	SWP-M-G
61 66 1 370 033	BMW	246-075-042-001C		SWP-M-G
61 66 1 370 033	BMW	246-082-003-013	246-075-042-001C	SWP-M-G
61 66 1 370 465	BMW	246-075-042-001C		SWP-M-G
61 66 1 370 465	BMW	246-082-003-013	246-075-042-001C	SWP-M-G
61 66 1 378 799	BMW	246-080-013-001Z		N-H
61 66 1 379 735	BMW	246-069-059-001Z		N
61 66 8 350 355	BMW	246-080-013-003Z		N-H
61 67 1 359 115	BMW	246-075-021-003	246-075-023-004C	SWP-M-G
61 67 1 359 115	BMW	246-075-023-003	246-075-023-004C	SWP-M-G
61 67 1 359 115	BMW	246-075-023-004C		SWP-M-G
61 67 1 359 116	BMW	246-075-021-003	246-075-023-004C	SWP-M-G
61 67 1 359 116	BMW	246-075-023-003	246-075-023-004C	SWP-M-G
61 67 1 359 116	BMW	246-075-023-004C		SWP-M-G
67 12 8 362 154	BMW	246-082-008-015N	246-082-008-025G	SWP-M-C
67 12 8 362 154	BMW	246-082-008-017	246-082-008-025G	SWP-M-C
67 12 8 362 154	BMW	246-082-008-019	246-082-008-025G	SWP-M-C
67 12 8 362 154	BMW	246-082-008-022	246-082-008-025G	SWP-M-C
67 12 8 362 154	BMW	246-082-008-025G		SWP-M-C
67 12 8 362 154	BMW	246-082-008-026	246-082-008-025G	SWP-M-C
67 12 8 377 430	BMW	246-086-001-004	246-086-001-007C	HLWP
67 12 8 377 430	BMW	246-086-001-007C		HLWP
67 12 8 377 430	BMW	246-086-001-016	246-086-001-007C	HLWP
67 12 8 377 612	BMW	246-082-008-015N	246-082-008-025G	SWP-M-C
67 12 8 377 612	BMW	246-082-008-017	246-082-008-025G	SWP-M-C
67 12 8 377 612	BMW	246-082-008-019	246-082-008-025G	SWP-M-C
67 12 8 377 612	BMW	246-082-008-022	246-082-008-025G	SWP-M-C
67 12 8 377 612	BMW	246-082-008-025G		SWP-M-C
67 12 8 377 612	BMW	246-082-008-026	246-082-008-025G	SWP-M-C
67 12 8 377 613	BMW	246-086-001-004	246-086-001-007C	HLWP
67 12 8 377 613	BMW	246-086-001-007C		HLWP
67 12 8 377 613	BMW	246-086-001-016	246-086-001-007C	HLWP
67 12 8 377 987	BMW	246-083-002-005C	246-083-002-022G	SWP-D-C
67 12 8 377 987	BMW	246-083-002-009	246-083-002-022G	SWP-D-C
67 12 8 377 987	BMW	246-083-002-010	246-083-002-022G	SWP-D-C
67 12 8 377 987	BMW	246-083-002-015	246-083-002-022G	SWP-D-C
67 12 8 377 987	BMW	246-083-002-019	246-083-002-022G	SWP-D-C
67 12 8 377 987	BMW	246-083-002-022G		SWP-D-C
690 955 651	VOLKSWAGEN	246-082-003-001	246-082-008-012C	SWP-M-C
690 955 651	VOLKSWAGEN	246-082-003-002	246-082-008-012C	SWP-M-C
690 955 651	VOLKSWAGEN	246-082-003-004C	246-082-008-012C	SWP-M-C



OE Nr.	Hersteller	Artikel Nr.	Artikel Nr. (neu)	Artikelbezeichnung
690 955 651	VOLKSWAGEN	246-082-003-009C	246-082-008-012C	SWP-M-C
690 955 651	VOLKSWAGEN	246-082-008-005	246-082-008-012C	SWP-M-C
690 955 651	VOLKSWAGEN	246-082-008-012C		SWP-M-C
73PG-17K624-AA	FORD	246-075-021-003	246-075-023-004C	SWP-M-G
73PG-17K624-AA	FORD	246-075-023-003	246-075-023-004C	SWP-M-G
73PG-17K624-AA	FORD	246-075-023-004C		SWP-M-G
81.26481-0033	MAN	89-602-050		G
81.26483-0001	MAN	88-326-001		C
81.26484-0002	MAN	246-063-013-001D		V
81.26485-6008	MAN	246-075-010-001C		SWP-M-G
81.26485-6008	MAN	246-075-024-004	246-075-010-001C	SWP-M-G
81.26485-6016	MAN	246-082-003-001	246-082-008-012C	SWP-M-C
81.26485-6016	MAN	246-082-003-002	246-082-008-012C	SWP-M-C
81.26485-6016	MAN	246-082-003-004C	246-082-008-012C	SWP-M-C
81.26485-6016	MAN	246-082-003-009C	246-082-008-012C	SWP-M-C
81.26485-6016	MAN	246-082-008-005	246-082-008-012C	SWP-M-C
81.26485-6016	MAN	246-082-008-012C		SWP-M-C
81.26485-6027	MAN	246-083-001-002	246-083-002-006G	SWP-D-C
81.26485-6027	MAN	246-083-001-006C		SWP-D-C
81.26485-6027	MAN	246-083-002-002C	246-083-002-006G	SWP-D-C
823 955 651	AUDI	246-075-015-016C	246-075-021-006C	SWP-M-G
823 955 651	AUDI	246-075-021-001	246-075-021-006C	SWP-M-G
823 955 651	AUDI	246-075-021-006C		SWP-M-G
823 955 651	PORSCHE	246-075-015-016C	246-075-021-006C	SWP-M-G
823 955 651	PORSCHE	246-075-021-001	246-075-021-006C	SWP-M-G
823 955 651	PORSCHE	246-075-021-006C		SWP-M-G
823 955 651	VOLKSWAGEN	246-075-015-016C	246-075-021-006C	SWP-M-G
823 955 651	VOLKSWAGEN	246-075-021-001	246-075-021-006C	SWP-M-G
823 955 651	VOLKSWAGEN	246-075-021-006C		SWP-M-G
83BB-17K624-BA	FORD	X10-729-002-008		SWP-M-C
86VB-17K624-AA	FORD	246-075-042-001C		SWP-M-G
86VB-17K624-AA	FORD	246-082-003-003	246-082-008-014C	SWP-M-C
86VB-17K624-AA	FORD	246-082-003-005C	246-082-008-014C	SWP-M-C
86VB-17K624-AA	FORD	246-082-003-007	246-082-008-014C	SWP-M-C
86VB-17K624-AA	FORD	246-082-003-011	246-082-008-014C	SWP-M-C
86VB-17K624-AA	FORD	246-082-003-013	246-075-042-001C	SWP-M-G
86VB-17K624-AA	FORD	246-082-003-016	246-082-008-014C	SWP-M-C
86VB-17K624-AA	FORD	246-082-008-008	246-082-008-014C	SWP-M-C
86VB-17K624-AA	FORD	246-082-008-009	246-082-008-014C	SWP-M-C
86VB-17K624-AA	FORD	246-082-008-014C		SWP-M-C
87AB-17K624-AC	FORD	X10-729-002-004		SWP-M-C
9 665 345	IVECO	246-082-003-001	246-082-008-012C	SWP-M-C
9 665 345	IVECO	246-082-003-002	246-082-008-012C	SWP-M-C
9 665 345	IVECO	246-082-003-004C	246-082-008-012C	SWP-M-C
9 665 345	IVECO	246-082-003-009C	246-082-008-012C	SWP-M-C
9 665 345	IVECO	246-082-008-005	246-082-008-012C	SWP-M-C
9 665 345	IVECO	246-082-008-012C		SWP-M-C
928.628.074.01	PORSCHE	246-075-015-001C		SWP-M-G
928.628.172.01	PORSCHE	246-075-042-001C		SWP-M-G



OE Nr.	Hersteller	Artikel Nr.	Artikel Nr. (neu)	Artikelbezeichnung
928.628.172.01	PORSCHE	246-082-003-013	246-075-042-001C	SWP-M-G
92AB-17K624-AA	FORD	X10-729-002-005		SWP-M-C
93BB-17K624-AA	FORD	X10-729-002-005		SWP-M-C
93BB-17K624-BA	FORD	X10-729-002-004		SWP-M-C
95VW-17K624-AA	FORD	246-083-002-001Z	246-083-002-014G	SWP-D-C
95VW-17K624-AA	FORD	246-083-002-007	246-083-002-014G	SWP-D-C
	FORD	246-083-002-008	246-083-002-014G	SWP-D-C
95VW-17K624-AA	FORD	246-083-002-012G	246-083-002-014G	SWP-D-C
95VW-17K624-AA	FORD	246-083-002-014G		SWP-D-C
996.624.502.00	PORSCHE	246-086-001-002C		HLWP
996.624.502.00	PORSCHE	246-086-001-005	246-086-001-002C	HLWP
996.624.502.00	PORSCHE	246-086-001-006	246-086-001-002C	HLWP
996.628.172.00	PORSCHE	246-082-008-015N	246-082-008-025G	SWP-M-C
996.628.172.00	PORSCHE	246-082-008-017	246-082-008-025G	SWP-M-C
996.628.172.00	PORSCHE	246-082-008-019	246-082-008-025G	SWP-M-C
996.628.172.00	PORSCHE	246-082-008-022	246-082-008-025G	SWP-M-C
996.628.172.00	PORSCHE	246-082-008-025G		SWP-M-C
996.628.172.00	PORSCHE	246-082-008-026	246-082-008-025G	SWP-M-C
MR911031	MITSUBISHI	246-086-001-002C		HLWP
MR911031	MITSUBISHI	246-086-001-005	246-086-001-002C	HLWP
MR911031	MITSUBISHI	246-086-001-006	246-086-001-002C	HLWP



Referenzliste

Artikel Nr. > OE Nr. (sortiert nach Hersteller)

Artikel Nr.	OE Nr.	Artikel Nr. (neu)	Artikelbezeichnung
-------------	--------	-------------------	--------------------

ALFA ROMEO

246-083-001-001	0046797755	246-083-001-004C	SWP-D-C
246-083-001-001	0071719636	246-083-001-004C	SWP-D-C
246-083-001-004C	0046797755		SWP-D-C
246-083-001-004C	0071719636		SWP-D-C

AUDI

246-075-015-016C	823 955 651	246-075-021-006C	SWP-M-G
246-075-021-001	823 955 651	246-075-021-006C	SWP-M-G
246-075-021-006C	823 955 651		SWP-M-G
246-082-003-003	431 955 651	246-082-008-014C	SWP-M-C
246-082-003-005C	431 955 651	246-082-008-014C	SWP-M-C
246-082-003-007	431 955 651	246-082-008-014C	SWP-M-C
246-082-003-011	431 955 651	246-082-008-014C	SWP-M-C
246-082-003-016	431 955 651	246-082-008-014C	SWP-M-C
246-082-008-008	431 955 651	246-082-008-014C	SWP-M-C
246-082-008-009	431 955 651	246-082-008-014C	SWP-M-C
246-082-008-014C	431 955 651		SWP-M-C
246-082-008-015N	1J5 955 651	246-082-008-025G	SWP-M-C
246-082-008-017	1J5 955 651	246-082-008-025G	SWP-M-C
246-082-008-019	1J5 955 651	246-082-008-025G	SWP-M-C
246-082-008-022	1J5 955 651	246-082-008-025G	SWP-M-C
246-082-008-025G	1J5 955 651		SWP-M-C
246-082-008-026	1J5 955 651	246-082-008-025G	SWP-M-C
246-083-002-005C	1J6 955 651	246-083-002-022G	SWP-D-C
246-083-002-005C	1T0 955 651 A	246-083-002-022G	SWP-D-C
246-083-002-009	1J6 955 651	246-083-002-022G	SWP-D-C
246-083-002-009	1T0 955 651 A	246-083-002-022G	SWP-D-C
246-083-002-010	1J6 955 651	246-083-002-022G	SWP-D-C
246-083-002-010	1T0 955 651 A	246-083-002-022G	SWP-D-C
246-083-002-015	1J6 955 651	246-083-002-022G	SWP-D-C
246-083-002-015	1T0 955 651 A	246-083-002-022G	SWP-D-C
246-083-002-019	1J6 955 651	246-083-002-022G	SWP-D-C
246-083-002-019	1T0 955 651 A	246-083-002-022G	SWP-D-C
246-083-002-022G	1J6 955 651		SWP-D-C
246-083-002-022G	1T0 955 651 A		SWP-D-C
246-086-001-002C	1J0 955 681		HLWP
246-086-001-004	3B7 955 681	246-086-001-007C	HLWP
246-086-001-005	1J0 955 681	246-086-001-002C	HLWP
246-086-001-006	1J0 955 681	246-086-001-002C	HLWP
246-086-001-007C	3B7 955 681		HLWP
246-086-001-016	3B7 955 681	246-086-001-007C	HLWP



Artikel Nr.	OE Nr.	Artikel Nr. (neu)	Artikelbezeichnung
-------------	--------	-------------------	--------------------

AUDI

X11-246-003-014	1J0 973 722 A		A
-----------------	---------------	--	---

BMW

246-063-013-001D	61 66 1 355 299		V
246-069-059-001Z	61 66 1 379 735		N
246-075-021-003	61 67 1 359 115	246-075-023-004C	SWP-M-G
246-075-021-003	61 67 1 359 116	246-075-023-004C	SWP-M-G
246-075-023-003	61 67 1 359 115	246-075-023-004C	SWP-M-G
246-075-023-003	61 67 1 359 116	246-075-023-004C	SWP-M-G
246-075-023-004C	61 67 1 359 115		SWP-M-G
246-075-023-004C	61 67 1 359 116		SWP-M-G
246-075-042-001C	61 66 1 368 549		SWP-M-G
246-075-042-001C	61 66 1 370 033		SWP-M-G
246-075-042-001C	61 66 1 370 465		SWP-M-G
246-080-013-001Z	61 66 1 378 799		N-H
246-080-013-003Z	61 66 8 350 355		N-H
246-082-003-013	61 66 1 368 549	246-075-042-001C	SWP-M-G
246-082-003-013	61 66 1 370 033	246-075-042-001C	SWP-M-G
246-082-003-013	61 66 1 370 465	246-075-042-001C	SWP-M-G
246-082-008-015N	67 12 8 362 154	246-082-008-025G	SWP-M-C
246-082-008-015N	67 12 8 377 612	246-082-008-025G	SWP-M-C
246-082-008-017	67 12 8 362 154	246-082-008-025G	SWP-M-C
246-082-008-017	67 12 8 377 612	246-082-008-025G	SWP-M-C
246-082-008-019	67 12 8 362 154	246-082-008-025G	SWP-M-C
246-082-008-019	67 12 8 377 612	246-082-008-025G	SWP-M-C
246-082-008-022	67 12 8 362 154	246-082-008-025G	SWP-M-C
246-082-008-022	67 12 8 377 612	246-082-008-025G	SWP-M-C
246-082-008-025G	67 12 8 362 154		SWP-M-C
246-082-008-025G	67 12 8 377 612		SWP-M-C
246-082-008-026	67 12 8 362 154	246-082-008-025G	SWP-M-C
246-082-008-026	67 12 8 377 612	246-082-008-025G	SWP-M-C
246-083-002-005C	67 12 8 377 987	246-083-002-022G	SWP-D-C
246-083-002-009	67 12 8 377 987	246-083-002-022G	SWP-D-C
246-083-002-010	67 12 8 377 987	246-083-002-022G	SWP-D-C
246-083-002-015	67 12 8 377 987	246-083-002-022G	SWP-D-C
246-083-002-019	67 12 8 377 987	246-083-002-022G	SWP-D-C
246-083-002-022G	67 12 8 377 987		SWP-D-C
246-086-001-004	67 12 8 377 430	246-086-001-007C	HLWP
246-086-001-004	67 12 8 377 613	246-086-001-007C	HLWP
246-086-001-007C	67 12 8 377 430		HLWP
246-086-001-007C	67 12 8 377 613		HLWP



Artikel Nr.	OE Nr.	Artikel Nr. (neu)	Artikelbezeichnung
-------------	--------	-------------------	--------------------

BMW

246-086-001-016	67 12 8 377 430	246-086-001-007C	HLWP
246-086-001-016	67 12 8 377 613	246-086-001-007C	HLWP
395-060-017-001C	61 31 1 369 263		FLS
88-326-001	61 66 1 350 885		C

CITROEN

X10-729-002-007	0000643458		SWP-M-C
-----------------	------------	--	---------

DAF

246-075-024-005C	0616422		SWP-M-G
246-082-003-001	0665345	246-082-008-012C	SWP-M-C
246-082-003-002	0665345	246-082-008-012C	SWP-M-C
246-082-003-004C	0665345	246-082-008-012C	SWP-M-C
246-082-003-009C	0665345	246-082-008-012C	SWP-M-C
246-082-008-005	0665345	246-082-008-012C	SWP-M-C
246-082-008-012C	0665345		SWP-M-C

FIAT

246-083-001-001	0046797755	246-083-001-004C	SWP-D-C
246-083-001-001	0071719636	246-083-001-004C	SWP-D-C
246-083-001-004C	0046797755		SWP-D-C
246-083-001-004C	0071719636		SWP-D-C

FORD

246-075-021-003	73PG-17K624-AA	246-075-023-004C	SWP-M-G
246-075-023-003	73PG-17K624-AA	246-075-023-004C	SWP-M-G
246-075-023-004C	73PG-17K624-AA		SWP-M-G
246-075-042-001C	86VB-17K624-AA		SWP-M-G
246-082-003-003	6153469	246-082-008-014C	SWP-M-C
246-082-003-003	86VB-17K624-AA	246-082-008-014C	SWP-M-C
246-082-003-005C	6153469	246-082-008-014C	SWP-M-C
246-082-003-005C	86VB-17K624-AA	246-082-008-014C	SWP-M-C
246-082-003-007	6153469	246-082-008-014C	SWP-M-C
246-082-003-007	86VB-17K624-AA	246-082-008-014C	SWP-M-C
246-082-003-011	6153469	246-082-008-014C	SWP-M-C
246-082-003-011	86VB-17K624-AA	246-082-008-014C	SWP-M-C
246-082-003-013	86VB-17K624-AA	246-075-042-001C	SWP-M-G
246-082-003-016	6153469	246-082-008-014C	SWP-M-C
246-082-003-016	86VB-17K624-AA	246-082-008-014C	SWP-M-C
246-082-008-008	6153469	246-082-008-014C	SWP-M-C
246-082-008-008	86VB-17K624-AA	246-082-008-014C	SWP-M-C
246-082-008-009	6153469	246-082-008-014C	SWP-M-C
246-082-008-009	86VB-17K624-AA	246-082-008-014C	SWP-M-C



Artikel Nr.	OE Nr.	Artikel Nr. (neu)	Artikelbezeichnung
-------------	--------	-------------------	--------------------

FORD

246-082-008-014C	6153469		SWP-M-C
246-082-008-014C	86VB-17K624-AA		SWP-M-C
246-083-002-001Z	7222079	246-083-002-014G	SWP-D-C
246-083-002-001Z	95VW-17K624-AA	246-083-002-014G	SWP-D-C
246-083-002-007	7222079	246-083-002-014G	SWP-D-C
246-083-002-007	95VW-17K624-AA	246-083-002-014G	SWP-D-C
246-083-002-008	7222079	246-083-002-014G	SWP-D-C
246-083-002-008	95VW-17K624-AA	246-083-002-014G	SWP-D-C
246-083-002-012G	7222079	246-083-002-014G	SWP-D-C
246-083-002-012G	95VW-17K624-AA	246-083-002-014G	SWP-D-C
246-083-002-014G	7222079		SWP-D-C
246-083-002-014G	95VW-17K624-AA		SWP-D-C
X10-729-002-004	1652613		SWP-M-C
X10-729-002-004	7003178		SWP-M-C
X10-729-002-004	87AB-17K624-AC		SWP-M-C
X10-729-002-004	93BB-17K624-BA		SWP-M-C
X10-729-002-005	6833495		SWP-M-C
X10-729-002-005	7003177		SWP-M-C
X10-729-002-005	92AB-17K624-AA		SWP-M-C
X10-729-002-005	93BB-17K624-AA		SWP-M-C
X10-729-002-008	6140949		SWP-M-C
X10-729-002-008	83BB-17K624-BA		SWP-M-C

IVECO

246-082-003-001	9 665 345	246-082-008-012C	SWP-M-C
246-082-003-002	9 665 345	246-082-008-012C	SWP-M-C
246-082-003-004C	9 665 345	246-082-008-012C	SWP-M-C
246-082-003-009C	9 665 345	246-082-008-012C	SWP-M-C
246-082-008-005	9 665 345	246-082-008-012C	SWP-M-C
246-082-008-012C	9 665 345		SWP-M-C

LADA

246-082-003-003	2108 5208009 20	246-082-008-014C	SWP-M-C
246-082-003-005C	2108 5208009 20	246-082-008-014C	SWP-M-C
246-082-003-007	2108 5208009 20	246-082-008-014C	SWP-M-C
246-082-003-011	2108 5208009 20	246-082-008-014C	SWP-M-C
246-082-003-016	2108 5208009 20	246-082-008-014C	SWP-M-C
246-082-008-008	2108 5208009 20	246-082-008-014C	SWP-M-C
246-082-008-009	2108 5208009 20	246-082-008-014C	SWP-M-C
246-082-008-014C	2108 5208009 20		SWP-M-C

LANCIA

246-083-001-001	0046797755	246-083-001-004C	SWP-D-C
246-083-001-001	0071719636	246-083-001-004C	SWP-D-C



Artikel Nr.	OE Nr.	Artikel Nr. (neu)	Artikelbezeichnung
-------------	--------	-------------------	--------------------

LANCIA

246-083-001-004C	0046797755		SWP-D-C
246-083-001-004C	0071719636		SWP-D-C

MAN

246-063-013-001D	81.26484-0002		V
246-075-010-001C	81.26485-6008		SWP-M-G
246-075-024-004	81.26485-6008	246-075-010-001C	SWP-M-G
246-082-003-001	81.26485-6016	246-082-008-012C	SWP-M-C
246-082-003-002	81.26485-6016	246-082-008-012C	SWP-M-C
246-082-003-004C	81.26485-6016	246-082-008-012C	SWP-M-C
246-082-003-009C	81.26485-6016	246-082-008-012C	SWP-M-C
246-082-008-005	81.26485-6016	246-082-008-012C	SWP-M-C
246-082-008-012C	81.26485-6016		SWP-M-C
246-083-001-002	81.26485-6027	246-083-002-006G	SWP-D-C
246-083-001-006C	81.26485-6027		SWP-D-C
246-083-002-002C	81.26485-6027	246-083-002-006G	SWP-D-C
88-326-001	81.26483-0001		C
89-602-050	81.26481-0033		G

MAZDA

X10-729-002-004	1E00 76 672		SWP-M-C
-----------------	-------------	--	---------

MERCEDES-BENZ

246-061-009-002D	000 869 21 20		R
246-063-004-001G	000 869 10 22		V
246-063-004-001G	608 869 00 14		V
246-063-016-001G	107 869 00 19		V
246-063-016-003A	116 860 01 69	246-063-016-003G	V
246-063-016-003G	115 860 01 69		V
246-068-003-001G	000 860 60 47		N
246-069-026-001G	000 869 24 47		N
246-069-029-004G	322 869 00 47		N
246-069-039-001	124 860 02 47	246-069-039-003G	N
246-069-039-003G	123 860 02 47		N
246-075-010-001C	000 869 24 21		SWP-M-G
246-075-015-001C	000 869 22 21		SWP-M-G
246-075-017-001	000 869 30 21	246-075-017-002C	SWP-M-G
246-075-017-001	108 869 01 21	246-075-017-002C	SWP-M-G
246-075-017-001	115 869 02 21	246-075-017-002C	SWP-M-G
246-075-017-002C	000 869 30 21		SWP-M-G
246-075-017-002C	108 869 01 21		SWP-M-G
246-075-017-002C	115 869 02 21		SWP-M-G
246-075-021-004	000 869 29 21	246-075-021-007C	SWP-M-G
246-075-021-004	000 869 30 21	246-075-021-007C	SWP-M-G



Artikel Nr.	OE Nr.	Artikel Nr. (neu)	Artikelbezeichnung
MERCEDES-BENZ			
246-075-021-007C	000 869 29 21		SWP-M-G
246-075-021-007C	000 869 30 21		SWP-M-G
246-075-023-020	000 869 22 21	246-075-015-001C	SWP-M-G
246-075-024-002C	000 869 31 21		SWP-M-G
246-075-050-007C	000 860 15 26		SWP-M-G
246-080-003-001	127 860 07 47	246-080-003-006D	N-H
246-080-003-006D	126 860 07 47		N-H
246-082-003-001	000 860 12 26	246-082-008-012C	SWP-M-C
246-082-003-001	000 860 32 26	246-082-008-012C	SWP-M-C
246-082-003-002	000 860 12 26	246-082-008-012C	SWP-M-C
246-082-003-002	000 860 32 26	246-082-008-012C	SWP-M-C
246-082-003-003	000 860 13 26	246-082-008-014C	SWP-M-C
246-082-003-003	000 860 20 26	246-082-008-014C	SWP-M-C
246-082-003-003	000 860 33 26	246-082-008-014C	SWP-M-C
246-082-003-004C	000 860 12 26	246-082-008-012C	SWP-M-C
246-082-003-004C	000 860 32 26	246-082-008-012C	SWP-M-C
246-082-003-005C	000 860 13 26	246-082-008-014C	SWP-M-C
246-082-003-005C	000 860 20 26	246-082-008-014C	SWP-M-C
246-082-003-005C	000 860 33 26	246-082-008-014C	SWP-M-C
246-082-003-007	000 860 13 26	246-082-008-014C	SWP-M-C
246-082-003-007	000 860 20 26	246-082-008-014C	SWP-M-C
246-082-003-007	000 860 33 26	246-082-008-014C	SWP-M-C
246-082-003-009C	000 860 12 26	246-082-008-012C	SWP-M-C
246-082-003-009C	000 860 32 26	246-082-008-012C	SWP-M-C
246-082-003-011	000 860 13 26	246-082-008-014C	SWP-M-C
246-082-003-011	000 860 20 26	246-082-008-014C	SWP-M-C
246-082-003-011	000 860 33 26	246-082-008-014C	SWP-M-C
246-082-003-016	000 860 13 26	246-082-008-014C	SWP-M-C
246-082-003-016	000 860 20 26	246-082-008-014C	SWP-M-C
246-082-003-016	000 860 33 26	246-082-008-014C	SWP-M-C
246-082-005-001	124 869 00 21	246-082-005-002C	SWP-M-C
246-082-005-001	124 869 01 21	246-082-005-002C	SWP-M-C
246-082-005-001	124 869 03 21	246-082-005-002C	SWP-M-C
246-082-005-001	124 869 04 21	246-082-005-002C	SWP-M-C
246-082-005-001	124 869 05 21	246-082-005-002C	SWP-M-C
246-082-005-001	124 869 06 21	246-082-005-002C	SWP-M-C
246-082-005-002C	124 869 00 21		SWP-M-C
246-082-005-002C	124 869 01 21		SWP-M-C
246-082-005-002C	124 869 03 21		SWP-M-C
246-082-005-002C	124 869 04 21		SWP-M-C
246-082-005-002C	124 869 05 21		SWP-M-C
246-082-005-002C	124 869 06 21		SWP-M-C
246-082-008-003	141 869 02 21	246-082-008-013P	SWP-M-C
246-082-008-003	203 869 00 21	246-082-008-013P	SWP-M-C
246-082-008-005	000 860 12 26	246-082-008-012C	SWP-M-C
246-082-008-005	000 860 32 26	246-082-008-012C	SWP-M-C
246-082-008-008	000 860 13 26	246-082-008-014C	SWP-M-C



Artikel Nr.	OE Nr.	Artikel Nr. (neu)	Artikelbezeichnung
-------------	--------	-------------------	--------------------

MERCEDES-BENZ

246-082-008-008	000 860 20 26	246-082-008-014C	SWP-M-C
246-082-008-008	000 860 33 26	246-082-008-014C	SWP-M-C
246-082-008-009	000 860 13 26	246-082-008-014C	SWP-M-C
246-082-008-009	000 860 20 26	246-082-008-014C	SWP-M-C
246-082-008-009	000 860 33 26	246-082-008-014C	SWP-M-C
246-082-008-011C	142 869 02 21	246-082-008-013P	SWP-M-C
246-082-008-011C	204 869 00 21	246-082-008-013P	SWP-M-C
246-082-008-012C	000 860 12 26		SWP-M-C
246-082-008-012C	000 860 32 26		SWP-M-C
246-082-008-013P	140 869 02 21		SWP-M-C
246-082-008-013P	202 869 00 21		SWP-M-C
246-082-008-014C	000 860 13 26		SWP-M-C
246-082-008-014C	000 860 20 26		SWP-M-C
246-082-008-014C	000 860 33 26		SWP-M-C
246-082-008-015N	210 869 08 21	246-082-008-025G	SWP-M-C
246-082-008-017	210 869 08 21	246-082-008-025G	SWP-M-C
246-082-008-019	210 869 08 21	246-082-008-025G	SWP-M-C
246-082-008-022	210 869 08 21	246-082-008-025G	SWP-M-C
246-082-008-025G	210 869 08 21		SWP-M-C
246-082-008-026	210 869 08 21	246-082-008-025G	SWP-M-C
88-205-001	000 869 01 58		C
88-326-004	107 869 00 24		C

MITSUBISHI

246-086-001-002C	MR911031		HLWP
246-086-001-005	MR911031	246-086-001-002C	HLWP
246-086-001-006	MR911031	246-086-001-002C	HLWP

OPEL

246-082-003-003	14 50 156	246-082-008-014C	SWP-M-C
246-082-003-003	14 50 174	246-082-008-014C	SWP-M-C
246-082-003-003	90045820	246-082-008-014C	SWP-M-C
246-082-003-005C	14 50 156	246-082-008-014C	SWP-M-C
246-082-003-005C	14 50 174	246-082-008-014C	SWP-M-C
246-082-003-005C	90045820	246-082-008-014C	SWP-M-C
246-082-003-007	14 50 156	246-082-008-014C	SWP-M-C
246-082-003-007	14 50 174	246-082-008-014C	SWP-M-C
246-082-003-007	90045820	246-082-008-014C	SWP-M-C
246-082-003-011	14 50 156	246-082-008-014C	SWP-M-C
246-082-003-011	14 50 174	246-082-008-014C	SWP-M-C
246-082-003-011	90045820	246-082-008-014C	SWP-M-C
246-082-003-016	14 50 156	246-082-008-014C	SWP-M-C
246-082-003-016	14 50 174	246-082-008-014C	SWP-M-C
246-082-003-016	90045820	246-082-008-014C	SWP-M-C
246-082-008-001Z	14 50 184	246-082-008-021G	SWP-M-C



Artikel Nr.	OE Nr.	Artikel Nr. (neu)	Artikelbezeichnung
-------------	--------	-------------------	--------------------

OPEL

246-082-008-001Z	90585761	246-082-008-021G	SWP-M-C
246-082-008-008	14 50 156	246-082-008-014C	SWP-M-C
246-082-008-008	14 50 174	246-082-008-014C	SWP-M-C
246-082-008-008	90045820	246-082-008-014C	SWP-M-C
246-082-008-009	14 50 156	246-082-008-014C	SWP-M-C
246-082-008-009	14 50 174	246-082-008-014C	SWP-M-C
246-082-008-009	90045820	246-082-008-014C	SWP-M-C
246-082-008-014C	14 50 156		SWP-M-C
246-082-008-014C	14 50 174		SWP-M-C
246-082-008-014C	90045820		SWP-M-C
246-082-008-018	14 50 184	246-082-008-021G	SWP-M-C
246-082-008-018	90585761	246-082-008-021G	SWP-M-C
246-082-008-021G	14 50 184		SWP-M-C
246-082-008-021G	90585761		SWP-M-C
246-083-001-001	14 50 175	246-083-001-004C	SWP-D-C
246-083-001-001	90226604	246-083-001-004C	SWP-D-C
246-083-001-004C	14 50 175		SWP-D-C
246-083-001-004C	90226604		SWP-D-C
246-083-002-001Z	14 50 185	246-083-002-014G	SWP-D-C
246-083-002-001Z	90585762	246-083-002-014G	SWP-D-C
246-083-002-007	14 50 185	246-083-002-014G	SWP-D-C
246-083-002-007	90585762	246-083-002-014G	SWP-D-C
246-083-002-008	14 50 185	246-083-002-014G	SWP-D-C
246-083-002-008	90585762	246-083-002-014G	SWP-D-C
246-083-002-012G	14 50 185	246-083-002-014G	SWP-D-C
246-083-002-012G	90585762	246-083-002-014G	SWP-D-C
246-083-002-014G	14 50 185		SWP-D-C
246-083-002-014G	90585762		SWP-D-C

PEUGEOT

X10-729-002-007	643458		SWP-M-C
-----------------	--------	--	---------

PORSCHE

246-075-015-001C	928.628.074.01		SWP-M-G
246-075-015-016C	823 955 651	246-075-021-006C	SWP-M-G
246-075-021-001	823 955 651	246-075-021-006C	SWP-M-G
246-075-021-006C	823 955 651		SWP-M-G
246-075-042-001C	928.628.172.01		SWP-M-G
246-082-003-013	928.628.172.01	246-075-042-001C	SWP-M-G
246-082-008-015N	996.628.172.00	246-082-008-025G	SWP-M-C
246-082-008-017	996.628.172.00	246-082-008-025G	SWP-M-C
246-082-008-019	996.628.172.00	246-082-008-025G	SWP-M-C
246-082-008-022	996.628.172.00	246-082-008-025G	SWP-M-C
246-082-008-025G	996.628.172.00		SWP-M-C
246-082-008-026	996.628.172.00	246-082-008-025G	SWP-M-C



Artikel Nr.	OE Nr.	Artikel Nr. (neu)	Artikelbezeichnung
-------------	--------	-------------------	--------------------

PORSCHE

246-086-001-002C	996.624.502.00		HLWP
246-086-001-005	996.624.502.00	246-086-001-002C	HLWP
246-086-001-006	996.624.502.00	246-086-001-002C	HLWP

RENAULT

X10-729-002-006	7700802336		SWP-M-C
-----------------	------------	--	---------

SAAB

246-082-001-001C	9506379		SWP-M-C
246-082-003-003	8593477	246-082-008-014C	SWP-M-C
246-082-003-005C	8593477	246-082-008-014C	SWP-M-C
246-082-003-007	8593477	246-082-008-014C	SWP-M-C
246-082-003-011	8593477	246-082-008-014C	SWP-M-C
246-082-003-016	8593477	246-082-008-014C	SWP-M-C
246-082-008-008	8593477	246-082-008-014C	SWP-M-C
246-082-008-009	8593477	246-082-008-014C	SWP-M-C
246-082-008-014C	8593477		SWP-M-C

SCANIA

246-063-013-001D	300786		V
246-069-050-005D	300792		N
246-075-044-003A	01395994		SWP-M-G
246-082-001-001C	367110		SWP-M-C
246-082-001-002C	353546		SWP-M-C
246-082-003-001	00000000295970	246-082-008-012C	SWP-M-C
246-082-003-002	00000000295970	246-082-008-012C	SWP-M-C
246-082-003-004C	00000000295970	246-082-008-012C	SWP-M-C
246-082-003-009C	00000000295970	246-082-008-012C	SWP-M-C
246-082-008-005	00000000295970	246-082-008-012C	SWP-M-C
246-082-008-012C	00000000295970		SWP-M-C

SEAT

246-069-056-001Z	191 955 985 A		N
246-080-010-002Z	191 955 986 A		N-H
246-082-003-003	431 955 651	246-082-008-014C	SWP-M-C
246-082-003-005C	431 955 651	246-082-008-014C	SWP-M-C
246-082-003-007	431 955 651	246-082-008-014C	SWP-M-C
246-082-003-011	431 955 651	246-082-008-014C	SWP-M-C
246-082-003-016	431 955 651	246-082-008-014C	SWP-M-C
246-082-008-001Z	1H5 955 651	246-082-008-021G	SWP-M-C
246-082-008-008	431 955 651	246-082-008-014C	SWP-M-C
246-082-008-009	431 955 651	246-082-008-014C	SWP-M-C
246-082-008-014C	431 955 651		SWP-M-C



Artikel Nr.	OE Nr.	Artikel Nr. (neu)	Artikelbezeichnung
SEAT			
246-082-008-015N	1J5 955 651	246-082-008-025G	SWP-M-C
246-082-008-017	1J5 955 651	246-082-008-025G	SWP-M-C
246-082-008-018	1H5 955 651	246-082-008-021G	SWP-M-C
246-082-008-019	1J5 955 651	246-082-008-025G	SWP-M-C
246-082-008-021G	1H5 955 651		SWP-M-C
246-082-008-022	1J5 955 651	246-082-008-025G	SWP-M-C
246-082-008-025G	1J5 955 651		SWP-M-C
246-082-008-026	1J5 955 651	246-082-008-025G	SWP-M-C
246-083-002-001Z	1H6 955 651	246-083-002-014G	SWP-D-C
246-083-002-005C	1J6 955 651	246-083-002-022G	SWP-D-C
246-083-002-005C	1T0 955 651 A	246-083-002-022G	SWP-D-C
246-083-002-007	1H6 955 651	246-083-002-014G	SWP-D-C
246-083-002-008	1H6 955 651	246-083-002-014G	SWP-D-C
246-083-002-009	1J6 955 651	246-083-002-022G	SWP-D-C
246-083-002-009	1T0 955 651 A	246-083-002-022G	SWP-D-C
246-083-002-010	1J6 955 651	246-083-002-022G	SWP-D-C
246-083-002-010	1T0 955 651 A	246-083-002-022G	SWP-D-C
246-083-002-012G	1H6 955 651	246-083-002-014G	SWP-D-C
246-083-002-014G	1H6 955 651		SWP-D-C
246-083-002-015	1J6 955 651	246-083-002-022G	SWP-D-C
246-083-002-015	1T0 955 651 A	246-083-002-022G	SWP-D-C
246-083-002-019	1J6 955 651	246-083-002-022G	SWP-D-C
246-083-002-019	1T0 955 651 A	246-083-002-022G	SWP-D-C
246-083-002-022G	1J6 955 651		SWP-D-C
246-083-002-022G	1T0 955 651 A		SWP-D-C
246-086-001-002C	1J0 955 681		HLWP
246-086-001-004	3B7 955 681	246-086-001-007C	HLWP
246-086-001-005	1J0 955 681	246-086-001-002C	HLWP
246-086-001-006	1J0 955 681	246-086-001-002C	HLWP
246-086-001-007C	3B7 955 681		HLWP
246-086-001-007C	3B7 955 681	246-086-001-007C	HLWP
246-086-001-016	3B7 955 681	246-086-001-007C	HLWP
X11-246-003-014	1J0 973 722 A		A

SKODA

246-082-008-015N	1J5 955 651	246-082-008-025G	SWP-M-C
246-082-008-015N	1T0 955 651	246-082-008-025G	SWP-M-C
246-082-008-017	1J5 955 651	246-082-008-025G	SWP-M-C
246-082-008-017	1T0 955 651	246-082-008-025G	SWP-M-C
246-082-008-019	1J5 955 651	246-082-008-025G	SWP-M-C
246-082-008-019	1T0 955 651	246-082-008-025G	SWP-M-C
246-082-008-022	1J5 955 651	246-082-008-025G	SWP-M-C
246-082-008-022	1T0 955 651	246-082-008-025G	SWP-M-C
246-082-008-025G	1J5 955 651		SWP-M-C
246-082-008-025G	1T0 955 651		SWP-M-C
246-082-008-026	1J5 955 651	246-082-008-025G	SWP-M-C



Artikel Nr.	OE Nr.	Artikel Nr. (neu)	Artikelbezeichnung
-------------	--------	-------------------	--------------------

SKODA

246-082-008-026	1T0 955 651	246-082-008-025G	SWP-M-C
246-083-002-005C	1J6 955 651	246-083-002-022G	SWP-D-C
246-083-002-005C	1T0 955 651 A	246-083-002-022G	SWP-D-C
246-083-002-009	1J6 955 651	246-083-002-022G	SWP-D-C
246-083-002-009	1T0 955 651 A	246-083-002-022G	SWP-D-C
246-083-002-010	1J6 955 651	246-083-002-022G	SWP-D-C
246-083-002-010	1T0 955 651 A	246-083-002-022G	SWP-D-C
246-083-002-015	1J6 955 651	246-083-002-022G	SWP-D-C
246-083-002-015	1T0 955 651 A	246-083-002-022G	SWP-D-C
246-083-002-019	1J6 955 651	246-083-002-022G	SWP-D-C
246-083-002-019	1T0 955 651 A	246-083-002-022G	SWP-D-C
246-083-002-022G	1J6 955 651		SWP-D-C
246-083-002-022G	1T0 955 651 A		SWP-D-C
246-086-001-002C	1J0 955 681		HLWP
246-086-001-004	3B0 955 681 A	246-086-001-007C	HLWP
246-086-001-004	3B7 955 681	246-086-001-007C	HLWP
246-086-001-005	1J0 955 681	246-086-001-002C	HLWP
246-086-001-006	1J0 955 681	246-086-001-002C	HLWP
246-086-001-007C	3B0 955 681 A		HLWP
246-086-001-007C	3B7 955 681		HLWP
246-086-001-007C	3B0 955 681 A	246-086-001-007C	HLWP
246-086-001-007C	3B7 955 681	246-086-001-007C	HLWP
246-086-001-016	3B0 955 681 A	246-086-001-007C	HLWP
246-086-001-016	3B7 955 681	246-086-001-007C	HLWP
X11-246-003-014	1J0 973 722 A		A

SMART (MCC)

246-082-008-015N	0001753V001000000	246-082-008-025G	SWP-M-C
246-082-008-017	0001753V001000000	246-082-008-025G	SWP-M-C
246-082-008-019	0001753V001000000	246-082-008-025G	SWP-M-C
246-082-008-022	0001753V001000000	246-082-008-025G	SWP-M-C
246-082-008-025G	0001753V001000000		SWP-M-C
246-082-008-026	0001753V001000000	246-082-008-025G	SWP-M-C
246-083-002-005C	0000038V001000000	246-083-002-022G	SWP-D-C
246-083-002-009	0000038V001000000	246-083-002-022G	SWP-D-C
246-083-002-010	0000038V001000000	246-083-002-022G	SWP-D-C
246-083-002-015	0000038V001000000	246-083-002-022G	SWP-D-C
246-083-002-019	0000038V001000000	246-083-002-022G	SWP-D-C
246-083-002-022G	0000038V001000000		SWP-D-C

VAUXHALL

246-082-003-003	14 50 174	246-082-008-014C	SWP-M-C
246-082-003-005C	14 50 174	246-082-008-014C	SWP-M-C
246-082-003-007	14 50 174	246-082-008-014C	SWP-M-C
246-082-003-011	14 50 174	246-082-008-014C	SWP-M-C



Artikel Nr.	OE Nr.	Artikel Nr. (neu)	Artikelbezeichnung
-------------	--------	-------------------	--------------------

VAUXHALL

246-082-003-016	14 50 174	246-082-008-014C	SWP-M-C
246-082-008-001Z	14 50 184	246-082-008-021G	SWP-M-C
246-082-008-001Z	90585761	246-082-008-021G	SWP-M-C
246-082-008-008	14 50 174	246-082-008-014C	SWP-M-C
246-082-008-009	14 50 174	246-082-008-014C	SWP-M-C
246-082-008-014C	14 50 174		SWP-M-C
246-082-008-018	14 50 184	246-082-008-021G	SWP-M-C
246-082-008-018	90585761	246-082-008-021G	SWP-M-C
246-082-008-021G	14 50 184		SWP-M-C
246-082-008-021G	90585761		SWP-M-C
246-083-001-001	14 50 175	246-083-001-004C	SWP-D-C
246-083-001-001	90492357	246-083-001-004C	SWP-D-C
246-083-001-004C	14 50 175		SWP-D-C
246-083-001-004C	90492357		SWP-D-C
246-083-002-001Z	14 50 185	246-083-002-014G	SWP-D-C
246-083-002-001Z	90585762	246-083-002-014G	SWP-D-C
246-083-002-007	14 50 185	246-083-002-014G	SWP-D-C
246-083-002-007	90585762	246-083-002-014G	SWP-D-C
246-083-002-008	14 50 185	246-083-002-014G	SWP-D-C
246-083-002-008	90585762	246-083-002-014G	SWP-D-C
246-083-002-012G	14 50 185	246-083-002-014G	SWP-D-C
246-083-002-012G	90585762	246-083-002-014G	SWP-D-C
246-083-002-014G	14 50 185		SWP-D-C
246-083-002-014G	90585762		SWP-D-C

VOLKSWAGEN

246-069-056-001Z	191 955 985 A		N
246-075-015-016C	823 955 651	246-075-021-006C	SWP-M-G
246-075-021-001	823 955 651	246-075-021-006C	SWP-M-G
246-075-021-006C	823 955 651		SWP-M-G
246-080-010-002Z	191 955 986 A		N-H
246-082-003-001	690 955 651	246-082-008-012C	SWP-M-C
246-082-003-002	690 955 651	246-082-008-012C	SWP-M-C
246-082-003-003	431 955 651	246-082-008-014C	SWP-M-C
246-082-003-004C	690 955 651	246-082-008-012C	SWP-M-C
246-082-003-005C	431 955 651	246-082-008-014C	SWP-M-C
246-082-003-007	431 955 651	246-082-008-014C	SWP-M-C
246-082-003-009C	690 955 651	246-082-008-012C	SWP-M-C
246-082-003-011	431 955 651	246-082-008-014C	SWP-M-C
246-082-003-016	431 955 651	246-082-008-014C	SWP-M-C
246-082-008-001Z	1H5 955 651	246-082-008-021G	SWP-M-C
246-082-008-005	690 955 651	246-082-008-012C	SWP-M-C
246-082-008-008	431 955 651	246-082-008-014C	SWP-M-C
246-082-008-009	431 955 651	246-082-008-014C	SWP-M-C
246-082-008-012C	690 955 651		SWP-M-C
246-082-008-014C	431 955 651		SWP-M-C



Artikel Nr.	OE Nr.	Artikel Nr. (neu)	Artikelbezeichnung
-------------	--------	-------------------	--------------------

VOLKSWAGEN

246-082-008-015N	1J5 955 651	246-082-008-025G	SWP-M-C
246-082-008-015N	1T0 955 651	246-082-008-025G	SWP-M-C
246-082-008-017	1J5 955 651	246-082-008-025G	SWP-M-C
246-082-008-017	1T0 955 651	246-082-008-025G	SWP-M-C
246-082-008-018	1H5 955 651	246-082-008-021G	SWP-M-C
246-082-008-019	1J5 955 651	246-082-008-025G	SWP-M-C
246-082-008-019	1T0 955 651	246-082-008-025G	SWP-M-C
246-082-008-021G	1H5 955 651		SWP-M-C
246-082-008-022	1J5 955 651	246-082-008-025G	SWP-M-C
246-082-008-022	1T0 955 651	246-082-008-025G	SWP-M-C
246-082-008-025G	1J5 955 651		SWP-M-C
246-082-008-025G	1T0 955 651		SWP-M-C
246-082-008-026	1J5 955 651	246-082-008-025G	SWP-M-C
246-082-008-026	1T0 955 651	246-082-008-025G	SWP-M-C
246-083-001-002	333 955 651	246-083-002-006G	SWP-D-C
246-083-002-001Z	1H6 955 651	246-083-002-014G	SWP-D-C
246-083-002-002C	333 955 651	246-083-002-006G	SWP-D-C
246-083-002-005C	1J6 955 651	246-083-002-022G	SWP-D-C
246-083-002-005C	1T0 955 651 A	246-083-002-022G	SWP-D-C
246-083-002-006G	333 955 651		SWP-D-C
246-083-002-007	1H6 955 651	246-083-002-014G	SWP-D-C
246-083-002-008	1H6 955 651	246-083-002-014G	SWP-D-C
246-083-002-009	1J6 955 651	246-083-002-022G	SWP-D-C
246-083-002-009	1T0 955 651 A	246-083-002-022G	SWP-D-C
246-083-002-010	1J6 955 651	246-083-002-022G	SWP-D-C
246-083-002-010	1T0 955 651 A	246-083-002-022G	SWP-D-C
246-083-002-012G	1H6 955 651	246-083-002-014G	SWP-D-C
246-083-002-014G	1H6 955 651		SWP-D-C
246-083-002-015	1J6 955 651	246-083-002-022G	SWP-D-C
246-083-002-015	1T0 955 651 A	246-083-002-022G	SWP-D-C
246-083-002-019	1J6 955 651	246-083-002-022G	SWP-D-C
246-083-002-019	1T0 955 651 A	246-083-002-022G	SWP-D-C
246-083-002-022G	1J6 955 651		SWP-D-C
246-083-002-022G	1T0 955 651 A	246-083-002-022G	SWP-D-C
246-086-001-002C	191 955 681		HLWP
246-086-001-002C	3B0 955 681		HLWP
246-086-001-004	3B0 955 681 A	246-086-001-007C	HLWP
246-086-001-004	3B7 955 681	246-086-001-007C	HLWP
246-086-001-005	191 955 681	246-086-001-002C	HLWP
246-086-001-005	3B0 955 681	246-086-001-002C	HLWP
246-086-001-006	191 955 681	246-086-001-002C	HLWP
246-086-001-006	3B0 955 681	246-086-001-002C	HLWP
246-086-001-007C	3B0 955 681 A		HLWP
246-086-001-007C	3B7 955 681		HLWP
246-086-001-007C	3B0 955 681 A	246-086-001-007C	HLWP
246-086-001-007C	3B7 955 681	246-086-001-007C	HLWP
246-086-001-016	3B0 955 681 A	246-086-001-007C	HLWP



Artikel Nr.	OE Nr.	Artikel Nr. (neu)	Artikelbezeichnung
-------------	--------	-------------------	--------------------

VOLKSWAGEN

246-086-001-016	3B7 955 681	246-086-001-007C	HLWP
X11-246-003-014	1J0 973 722 A		A

VOLVO

246-063-004-001G	1342553		V
246-068-013-004D	1307159		N
246-068-050-003D	1307159	246-068-013-004D	N
246-069-050-005D	4831689		N
246-075-015-016C	1254197	246-075-021-006C	SWP-M-G
246-075-021-001	1254197	246-075-021-006C	SWP-M-G
246-075-021-003	3276564	246-075-023-004C	SWP-M-G
246-075-021-006C	1254197		SWP-M-G
246-075-023-003	3276564	246-075-023-004C	SWP-M-G
246-075-023-004C	3276564		SWP-M-G
246-075-040-020C	1585878		SWP-M-G
246-075-042-001C	3205207		SWP-M-G
246-075-044-001C	1258016		SWP-M-G
246-075-044-002A	1259832		SWP-M-G
246-075-051-002	1304783	246-075-051-003C	SWP-M-G
246-075-051-002	1304784	246-075-051-003C	SWP-M-G
246-075-051-003C	1304783		SWP-M-G
246-075-051-003C	1304784		SWP-M-G
246-075-051-007C	1606929		SWP-M-G
246-082-003-013	3205207	246-075-042-001C	SWP-M-G



Referenzliste

Artikel Nr. > OE Nr. (alle Hersteller)

Artikel Nr.	OE Nr.	Hersteller	Artikel Nr. (neu)	Artikelbezeichnung
246-061-009-002D	000 869 21 20	MERCEDES-BENZ		R
246-061-022-001C				R
246-063-004-001G	1342553	VOLVO		V
246-063-004-001G	000 869 10 22	MERCEDES-BENZ		V
246-063-004-001G	608 869 00 14	MERCEDES-BENZ		V
246-063-012-001G				V
246-063-013-001D	300786	SCANIA		V
246-063-013-001D	61 66 1 355 299	BMW		V
246-063-013-001D	81.26484-0002	MAN		V
246-063-016-001G	107 869 00 19	MERCEDES-BENZ		V
246-063-016-003A	116 860 01 69	MERCEDES-BENZ	246-063-016-003G	V
246-063-016-003G	115 860 01 69	MERCEDES-BENZ		V
246-068-003-001G	000 860 60 47	MERCEDES-BENZ		N
246-068-013-004D	1307159	VOLVO		N
246-068-050-003D	1307159	VOLVO	246-068-013-004D	N
246-069-026-001G	000 869 24 47	MERCEDES-BENZ		N
246-069-029-004G	322 869 00 47	MERCEDES-BENZ		N
246-069-039-001	124 860 02 47	MERCEDES-BENZ	246-069-039-003G	N
246-069-050-005D	300792	SCANIA		N
246-069-050-005D	4831689	VOLVO		N
246-069-056-001Z	191 955 985 A	SEAT		N
246-069-056-001Z	191 955 985 A	VOLKSWAGEN		N
246-069-059-001Z	61 66 1 379 735	BMW		N
246-075-010-001C	000 869 24 21	MERCEDES-BENZ		SWP-M-G
246-075-010-001C	81.26485-6008	MAN		SWP-M-G
246-075-015-001C	000 869 22 21	MERCEDES-BENZ		SWP-M-G
246-075-015-001C	928.628.074.01	PORSCHE		SWP-M-G
246-075-015-016C	1254197	VOLVO	246-075-021-006C	SWP-M-G
246-075-015-016C	823 955 651	AUDI	246-075-021-006C	SWP-M-G
246-075-015-016C	823 955 651	PORSCHE	246-075-021-006C	SWP-M-G
246-075-015-016C	823 955 651	VOLKSWAGEN	246-075-021-006C	SWP-M-G
246-075-017-001	000 869 30 21	MERCEDES-BENZ	246-075-017-002C	SWP-M-G
246-075-017-001	108 869 01 21	MERCEDES-BENZ	246-075-017-002C	SWP-M-G
246-075-017-001	115 869 02 21	MERCEDES-BENZ	246-075-017-002C	SWP-M-G
246-075-017-002C	000 869 30 21	MERCEDES-BENZ		SWP-M-G
246-075-017-002C	108 869 01 21	MERCEDES-BENZ		SWP-M-G
246-075-017-002C	115 869 02 21	MERCEDES-BENZ		SWP-M-G
246-075-021-001	1254197	VOLVO	246-075-021-006C	SWP-M-G
246-075-021-001	823 955 651	AUDI	246-075-021-006C	SWP-M-G
246-075-021-001	823 955 651	PORSCHE	246-075-021-006C	SWP-M-G
246-075-021-001	823 955 651	VOLKSWAGEN	246-075-021-006C	SWP-M-G
246-075-021-003	3276564	VOLVO	246-075-023-004C	SWP-M-G
246-075-021-003	61 67 1 359 115	BMW	246-075-023-004C	SWP-M-G
246-075-021-003	61 67 1 359 116	BMW	246-075-023-004C	SWP-M-G



Artikel Nr.	OE Nr.	Hersteller	Artikel Nr. (neu)	Artikelbezeichnung
246-075-021-003	73PG-17K624-AA	FORD	246-075-023-004C	SWP-M-G
246-075-021-004	000 869 29 21	MERCEDES-BENZ	246-075-021-007C	SWP-M-G
246-075-021-004	000 869 30 21	MERCEDES-BENZ	246-075-021-007C	SWP-M-G
246-075-021-006C	1254197	VOLVO		SWP-M-G
246-075-021-006C	823 955 651	AUDI		SWP-M-G
246-075-021-006C	823 955 651	PORSCHE		SWP-M-G
246-075-021-006C	823 955 651	VOLKSWAGEN		SWP-M-G
246-075-021-007C	000 869 29 21	MERCEDES-BENZ		SWP-M-G
246-075-021-007C	000 869 30 21	MERCEDES-BENZ		SWP-M-G
246-075-023-003	3276564	VOLVO	246-075-023-004C	SWP-M-G
246-075-023-003	61 67 1 359 115	BMW	246-075-023-004C	SWP-M-G
246-075-023-003	61 67 1 359 116	BMW	246-075-023-004C	SWP-M-G
246-075-023-003	73PG-17K624-AA	FORD	246-075-023-004C	SWP-M-G
246-075-023-004C	3276564	VOLVO		SWP-M-G
246-075-023-004C	61 67 1 359 115	BMW		SWP-M-G
246-075-023-004C	61 67 1 359 116	BMW		SWP-M-G
246-075-023-004C	73PG-17K624-AA	FORD		SWP-M-G
246-075-023-020	000 869 22 21	MERCEDES-BENZ	246-075-015-001C	SWP-M-G
246-075-024-002C	000 869 31 21	MERCEDES-BENZ		SWP-M-G
246-075-024-004	81.26485-6008	MAN	246-075-010-001C	SWP-M-G
246-075-024-005C	0616422	DAF		SWP-M-G
246-075-040-020C	1585878	VOLVO		SWP-M-G
246-075-042-001C	3205207	VOLVO		SWP-M-G
246-075-042-001C	61 66 1 368 549	BMW		SWP-M-G
246-075-042-001C	61 66 1 370 033	BMW		SWP-M-G
246-075-042-001C	61 66 1 370 465	BMW		SWP-M-G
246-075-042-001C	86VB-17K624-AA	FORD		SWP-M-G
246-075-042-001C	928.628.172.01	PORSCHE		SWP-M-G
246-075-044-001C	1258016	VOLVO		SWP-M-G
246-075-044-002A	1259832	VOLVO		SWP-M-G
246-075-044-003A	01395994	SCANIA		SWP-M-G
246-075-050-007C	000 860 15 26	MERCEDES-BENZ		SWP-M-G
246-075-051-002	1304783	VOLVO	246-075-051-003C	SWP-M-G
246-075-051-002	1304784	VOLVO	246-075-051-003C	SWP-M-G
246-075-051-003C	1304783	VOLVO		SWP-M-G
246-075-051-003C	1304784	VOLVO		SWP-M-G
246-075-051-007C	1606929	VOLVO		SWP-M-G
246-080-003-001	127 860 07 47	MERCEDES-BENZ	246-080-003-006D	N-H
246-080-003-006D	126 860 07 47	MERCEDES-BENZ		N-H
246-080-010-002Z	191 955 986 A	SEAT		N-H
246-080-010-002Z	191 955 986 A	VOLKSWAGEN		N-H
246-080-013-001Z	61 66 1 378 799	BMW		N-H
246-080-013-003Z	61 66 8 350 355	BMW		N-H
246-082-001-001C	367110	SCANIA		SWP-M-C



Artikel Nr.	OE Nr.	Hersteller	Artikel Nr. (neu)	Artikelbezeichnung
246-082-001-001C	9506379	SAAB		SWP-M-C
246-082-001-002C	353546	SCANIA		SWP-M-C
246-082-003-001	00000000295970	SCANIA	246-082-008-012C	SWP-M-C
246-082-003-001	0665345	DAF	246-082-008-012C	SWP-M-C
246-082-003-001	000 860 12 26	MERCEDES-BENZ	246-082-008-012C	SWP-M-C
246-082-003-001	000 860 32 26	MERCEDES-BENZ	246-082-008-012C	SWP-M-C
246-082-003-001	690 955 651	VOLKSWAGEN	246-082-008-012C	SWP-M-C
246-082-003-001	81.26485-6016	MAN	246-082-008-012C	SWP-M-C
246-082-003-001	9 665 345	IVECO	246-082-008-012C	SWP-M-C
246-082-003-002	00000000295970	SCANIA	246-082-008-012C	SWP-M-C
246-082-003-002	0665345	DAF	246-082-008-012C	SWP-M-C
246-082-003-002	000 860 12 26	MERCEDES-BENZ	246-082-008-012C	SWP-M-C
246-082-003-002	000 860 32 26	MERCEDES-BENZ	246-082-008-012C	SWP-M-C
246-082-003-002	690 955 651	VOLKSWAGEN	246-082-008-012C	SWP-M-C
246-082-003-002	81.26485-6016	MAN	246-082-008-012C	SWP-M-C
246-082-003-002	9 665 345	IVECO	246-082-008-012C	SWP-M-C
246-082-003-003	6153469	FORD	246-082-008-014C	SWP-M-C
246-082-003-003	8593477	SAAB	246-082-008-014C	SWP-M-C
246-082-003-003	90045820	OPEL	246-082-008-014C	SWP-M-C
246-082-003-003	000 860 13 26	MERCEDES-BENZ	246-082-008-014C	SWP-M-C
246-082-003-003	000 860 20 26	MERCEDES-BENZ	246-082-008-014C	SWP-M-C
246-082-003-003	000 860 33 26	MERCEDES-BENZ	246-082-008-014C	SWP-M-C
246-082-003-003	14 50 156	OPEL	246-082-008-014C	SWP-M-C
246-082-003-003	14 50 174	OPEL	246-082-008-014C	SWP-M-C
246-082-003-003	14 50 174	VAUXHALL	246-082-008-014C	SWP-M-C
246-082-003-003	2108 5208009 20	LADA	246-082-008-014C	SWP-M-C
246-082-003-003	431 955 651	AUDI	246-082-008-014C	SWP-M-C
246-082-003-003	431 955 651	SEAT	246-082-008-014C	SWP-M-C
246-082-003-003	431 955 651	VOLKSWAGEN	246-082-008-014C	SWP-M-C
246-082-003-003	86VB-17K624-AA	FORD	246-082-008-014C	SWP-M-C
246-082-003-004C	00000000295970	SCANIA	246-082-008-012C	SWP-M-C
246-082-003-004C	0665345	DAF	246-082-008-012C	SWP-M-C
246-082-003-004C	000 860 12 26	MERCEDES-BENZ	246-082-008-012C	SWP-M-C
246-082-003-004C	000 860 32 26	MERCEDES-BENZ	246-082-008-012C	SWP-M-C
246-082-003-004C	690 955 651	VOLKSWAGEN	246-082-008-012C	SWP-M-C
246-082-003-004C	81.26485-6016	MAN	246-082-008-012C	SWP-M-C
246-082-003-004C	9 665 345	IVECO	246-082-008-012C	SWP-M-C
246-082-003-005C	6153469	FORD	246-082-008-014C	SWP-M-C
246-082-003-005C	8593477	SAAB	246-082-008-014C	SWP-M-C
246-082-003-005C	90045820	OPEL	246-082-008-014C	SWP-M-C
246-082-003-005C	000 860 13 26	MERCEDES-BENZ	246-082-008-014C	SWP-M-C
246-082-003-005C	000 860 20 26	MERCEDES-BENZ	246-082-008-014C	SWP-M-C
246-082-003-005C	000 860 33 26	MERCEDES-BENZ	246-082-008-014C	SWP-M-C
246-082-003-005C	14 50 156	OPEL	246-082-008-014C	SWP-M-C
246-082-003-005C	14 50 174	OPEL	246-082-008-014C	SWP-M-C
246-082-003-005C	14 50 174	VAUXHALL	246-082-008-014C	SWP-M-C
246-082-003-005C	2108 5208009 20	LADA	246-082-008-014C	SWP-M-C
246-082-003-005C	431 955 651	AUDI	246-082-008-014C	SWP-M-C
246-082-003-005C	431 955 651	SEAT	246-082-008-014C	SWP-M-C



Artikel Nr.	OE Nr.	Hersteller	Artikel Nr. (neu)	Artikelbezeichnung
246-082-003-005C	431 955 651	VOLKSWAGEN	246-082-008-014C	SWP-M-C
246-082-003-005C	86VB-17K624-AA	FORD	246-082-008-014C	SWP-M-C
246-082-003-007	6153469	FORD	246-082-008-014C	SWP-M-C
246-082-003-007	8593477	SAAB	246-082-008-014C	SWP-M-C
246-082-003-007	90045820	OPEL	246-082-008-014C	SWP-M-C
246-082-003-007	000 860 13 26	MERCEDES-BENZ	246-082-008-014C	SWP-M-C
246-082-003-007	000 860 20 26	MERCEDES-BENZ	246-082-008-014C	SWP-M-C
246-082-003-007	000 860 33 26	MERCEDES-BENZ	246-082-008-014C	SWP-M-C
246-082-003-007	14 50 156	OPEL	246-082-008-014C	SWP-M-C
246-082-003-007	14 50 174	OPEL	246-082-008-014C	SWP-M-C
246-082-003-007	14 50 174	VAUXHALL	246-082-008-014C	SWP-M-C
246-082-003-007	2108 5208009 20	LADA	246-082-008-014C	SWP-M-C
246-082-003-007	431 955 651	AUDI	246-082-008-014C	SWP-M-C
246-082-003-007	431 955 651	SEAT	246-082-008-014C	SWP-M-C
246-082-003-007	431 955 651	VOLKSWAGEN	246-082-008-014C	SWP-M-C
246-082-003-007	86VB-17K624-AA	FORD	246-082-008-014C	SWP-M-C
246-082-003-009C	00000000295970	SCANIA	246-082-008-012C	SWP-M-C
246-082-003-009C	0665345	DAF	246-082-008-012C	SWP-M-C
246-082-003-009C	000 860 12 26	MERCEDES-BENZ	246-082-008-012C	SWP-M-C
246-082-003-009C	000 860 32 26	MERCEDES-BENZ	246-082-008-012C	SWP-M-C
246-082-003-009C	690 955 651	VOLKSWAGEN	246-082-008-012C	SWP-M-C
246-082-003-009C	81.26485-6016	MAN	246-082-008-012C	SWP-M-C
246-082-003-009C	9 665 345	IVECO	246-082-008-012C	SWP-M-C
246-082-003-011	6153469	FORD	246-082-008-014C	SWP-M-C
246-082-003-011	8593477	SAAB	246-082-008-014C	SWP-M-C
246-082-003-011	90045820	OPEL	246-082-008-014C	SWP-M-C
246-082-003-011	000 860 13 26	MERCEDES-BENZ	246-082-008-014C	SWP-M-C
246-082-003-011	000 860 20 26	MERCEDES-BENZ	246-082-008-014C	SWP-M-C
246-082-003-011	000 860 33 26	MERCEDES-BENZ	246-082-008-014C	SWP-M-C
246-082-003-011	14 50 156	OPEL	246-082-008-014C	SWP-M-C
246-082-003-011	14 50 174	OPEL	246-082-008-014C	SWP-M-C
246-082-003-011	14 50 174	VAUXHALL	246-082-008-014C	SWP-M-C
246-082-003-011	2108 5208009 20	LADA	246-082-008-014C	SWP-M-C
246-082-003-011	431 955 651	AUDI	246-082-008-014C	SWP-M-C
246-082-003-011	431 955 651	SEAT	246-082-008-014C	SWP-M-C
246-082-003-011	431 955 651	VOLKSWAGEN	246-082-008-014C	SWP-M-C
246-082-003-011	86VB-17K624-AA	FORD	246-082-008-014C	SWP-M-C
246-082-003-013	3205207	VOLVO	246-075-042-001C	SWP-M-G
246-082-003-013	61 66 1 368 549	BMW	246-075-042-001C	SWP-M-G
246-082-003-013	61 66 1 370 033	BMW	246-075-042-001C	SWP-M-G
246-082-003-013	61 66 1 370 465	BMW	246-075-042-001C	SWP-M-G
246-082-003-013	86VB-17K624-AA	FORD	246-075-042-001C	SWP-M-G
246-082-003-013	928.628.172.01	PORSCHE	246-075-042-001C	SWP-M-G
246-082-003-016	6153469	FORD	246-082-008-014C	SWP-M-C
246-082-003-016	8593477	SAAB	246-082-008-014C	SWP-M-C
246-082-003-016	90045820	OPEL	246-082-008-014C	SWP-M-C
246-082-003-016	000 860 13 26	MERCEDES-BENZ	246-082-008-014C	SWP-M-C
246-082-003-016	000 860 20 26	MERCEDES-BENZ	246-082-008-014C	SWP-M-C
246-082-003-016	000 860 33 26	MERCEDES-BENZ	246-082-008-014C	SWP-M-C



Artikel Nr.	OE Nr.	Hersteller	Artikel Nr. (neu)	Artikelbezeichnung
246-082-003-016	14 50 156	OPEL	246-082-008-014C	SWP-M-C
246-082-003-016	14 50 174	OPEL	246-082-008-014C	SWP-M-C
246-082-003-016	14 50 174	VAUXHALL	246-082-008-014C	SWP-M-C
246-082-003-016	2108 5208009 20	LADA	246-082-008-014C	SWP-M-C
246-082-003-016	431 955 651	AUDI	246-082-008-014C	SWP-M-C
246-082-003-016	431 955 651	SEAT	246-082-008-014C	SWP-M-C
246-082-003-016	431 955 651	VOLKSWAGEN	246-082-008-014C	SWP-M-C
246-082-003-016	86VB-17K624-AA	FORD	246-082-008-014C	SWP-M-C
246-082-005-001	124 869 00 21	MERCEDES-BENZ	246-082-005-002C	SWP-M-C
246-082-005-001	124 869 01 21	MERCEDES-BENZ	246-082-005-002C	SWP-M-C
246-082-005-001	124 869 03 21	MERCEDES-BENZ	246-082-005-002C	SWP-M-C
246-082-005-001	124 869 04 21	MERCEDES-BENZ	246-082-005-002C	SWP-M-C
246-082-005-001	124 869 05 21	MERCEDES-BENZ	246-082-005-002C	SWP-M-C
246-082-005-001	124 869 06 21	MERCEDES-BENZ	246-082-005-002C	SWP-M-C
246-082-005-002C	124 869 00 21	MERCEDES-BENZ		SWP-M-C
246-082-005-002C	124 869 01 21	MERCEDES-BENZ		SWP-M-C
246-082-005-002C	124 869 03 21	MERCEDES-BENZ		SWP-M-C
246-082-005-002C	124 869 04 21	MERCEDES-BENZ		SWP-M-C
246-082-005-002C	124 869 05 21	MERCEDES-BENZ		SWP-M-C
246-082-005-002C	124 869 06 21	MERCEDES-BENZ		SWP-M-C
246-082-008-001Z	90585761	OPEL	246-082-008-021G	SWP-M-C
246-082-008-001Z	90585761	VAUXHALL	246-082-008-021G	SWP-M-C
246-082-008-001Z	14 50 184	OPEL	246-082-008-021G	SWP-M-C
246-082-008-001Z	14 50 184	VAUXHALL	246-082-008-021G	SWP-M-C
246-082-008-001Z	1H5 955 651	SEAT	246-082-008-021G	SWP-M-C
246-082-008-001Z	1H5 955 651	VOLKSWAGEN	246-082-008-021G	SWP-M-C
246-082-008-003	141 869 02 21	MERCEDES-BENZ	246-082-008-013P	SWP-M-C
246-082-008-003	203 869 00 21	MERCEDES-BENZ	246-082-008-013P	SWP-M-C
246-082-008-005	00000000295970	SCANIA	246-082-008-012C	SWP-M-C
246-082-008-005	0665345	DAF	246-082-008-012C	SWP-M-C
246-082-008-005	000 860 12 26	MERCEDES-BENZ	246-082-008-012C	SWP-M-C
246-082-008-005	000 860 32 26	MERCEDES-BENZ	246-082-008-012C	SWP-M-C
246-082-008-005	690 955 651	VOLKSWAGEN	246-082-008-012C	SWP-M-C
246-082-008-005	81.26485-6016	MAN	246-082-008-012C	SWP-M-C
246-082-008-005	9 665 345	IVECO	246-082-008-012C	SWP-M-C
246-082-008-008	6153469	FORD	246-082-008-014C	SWP-M-C
246-082-008-008	8593477	SAAB	246-082-008-014C	SWP-M-C
246-082-008-008	90045820	OPEL	246-082-008-014C	SWP-M-C
246-082-008-008	000 860 13 26	MERCEDES-BENZ	246-082-008-014C	SWP-M-C
246-082-008-008	000 860 20 26	MERCEDES-BENZ	246-082-008-014C	SWP-M-C
246-082-008-008	000 860 33 26	MERCEDES-BENZ	246-082-008-014C	SWP-M-C
246-082-008-008	14 50 156	OPEL	246-082-008-014C	SWP-M-C
246-082-008-008	14 50 174	OPEL	246-082-008-014C	SWP-M-C
246-082-008-008	14 50 174	VAUXHALL	246-082-008-014C	SWP-M-C
246-082-008-008	2108 5208009 20	LADA	246-082-008-014C	SWP-M-C
246-082-008-008	431 955 651	AUDI	246-082-008-014C	SWP-M-C
246-082-008-008	431 955 651	SEAT	246-082-008-014C	SWP-M-C
246-082-008-008	431 955 651	VOLKSWAGEN	246-082-008-014C	SWP-M-C
246-082-008-008	86VB-17K624-AA	FORD	246-082-008-014C	SWP-M-C



Artikel Nr.	OE Nr.	Hersteller	Artikel Nr. (neu)	Artikelbezeichnung
246-082-008-009	6153469	FORD	246-082-008-014C	SWP-M-C
246-082-008-009	8593477	SAAB	246-082-008-014C	SWP-M-C
246-082-008-009	90045820	OPEL	246-082-008-014C	SWP-M-C
246-082-008-009	000 860 13 26	MERCEDES-BENZ	246-082-008-014C	SWP-M-C
246-082-008-009	000 860 20 26	MERCEDES-BENZ	246-082-008-014C	SWP-M-C
246-082-008-009	000 860 33 26	MERCEDES-BENZ	246-082-008-014C	SWP-M-C
246-082-008-009	14 50 156	OPEL	246-082-008-014C	SWP-M-C
246-082-008-009	14 50 174	OPEL	246-082-008-014C	SWP-M-C
246-082-008-009	14 50 174	VAUXHALL	246-082-008-014C	SWP-M-C
246-082-008-009	2108 5208009 20	LADA	246-082-008-014C	SWP-M-C
246-082-008-009	431 955 651	AUDI	246-082-008-014C	SWP-M-C
246-082-008-009	431 955 651	SEAT	246-082-008-014C	SWP-M-C
246-082-008-009	431 955 651	VOLKSWAGEN	246-082-008-014C	SWP-M-C
246-082-008-009	86VB-17K624-AA	FORD	246-082-008-014C	SWP-M-C
246-082-008-011C	142 869 02 21	MERCEDES-BENZ	246-082-008-013P	SWP-M-C
246-082-008-011C	204 869 00 21	MERCEDES-BENZ	246-082-008-013P	SWP-M-C
246-082-008-012C	00000000295970	SCANIA		SWP-M-C
246-082-008-012C	0665345	DAF		SWP-M-C
246-082-008-012C	000 860 12 26	MERCEDES-BENZ		SWP-M-C
246-082-008-012C	000 860 32 26	MERCEDES-BENZ		SWP-M-C
246-082-008-012C	690 955 651	VOLKSWAGEN		SWP-M-C
246-082-008-012C	81.26485-6016	MAN		SWP-M-C
246-082-008-012C	9 665 345	IVECO		SWP-M-C
246-082-008-013P	140 869 02 21	MERCEDES-BENZ		SWP-M-C
246-082-008-013P	202 869 00 21	MERCEDES-BENZ		SWP-M-C
246-082-008-014C	6153469	FORD		SWP-M-C
246-082-008-014C	8593477	SAAB		SWP-M-C
246-082-008-014C	90045820	OPEL		SWP-M-C
246-082-008-014C	000 860 13 26	MERCEDES-BENZ		SWP-M-C
246-082-008-014C	000 860 20 26	MERCEDES-BENZ		SWP-M-C
246-082-008-014C	000 860 33 26	MERCEDES-BENZ		SWP-M-C
246-082-008-014C	14 50 156	OPEL		SWP-M-C
246-082-008-014C	14 50 174	OPEL		SWP-M-C
246-082-008-014C	14 50 174	VAUXHALL		SWP-M-C
246-082-008-014C	2108 5208009 20	LADA		SWP-M-C
246-082-008-014C	431 955 651	AUDI		SWP-M-C
246-082-008-014C	431 955 651	SEAT		SWP-M-C
246-082-008-014C	431 955 651	VOLKSWAGEN		SWP-M-C
246-082-008-014C	86VB-17K624-AA	FORD		SWP-M-C
246-082-008-015N	0001753V001000000	SMART (MCC)	246-082-008-025G	SWP-M-C
246-082-008-015N	1J5 955 651	AUDI	246-082-008-025G	SWP-M-C
246-082-008-015N	1J5 955 651	SEAT	246-082-008-025G	SWP-M-C
246-082-008-015N	1J5 955 651	SKODA	246-082-008-025G	SWP-M-C
246-082-008-015N	1J5 955 651	VOLKSWAGEN	246-082-008-025G	SWP-M-C
246-082-008-015N	1T0 955 651	SKODA	246-082-008-025G	SWP-M-C
246-082-008-015N	1T0 955 651	VOLKSWAGEN	246-082-008-025G	SWP-M-C
246-082-008-015N	210 869 08 21	MERCEDES-BENZ	246-082-008-025G	SWP-M-C
246-082-008-015N	67 12 8 362 154	BMW	246-082-008-025G	SWP-M-C
246-082-008-015N	67 12 8 377 612	BMW	246-082-008-025G	SWP-M-C



Artikel Nr.	OE Nr.	Hersteller	Artikel Nr. (neu)	Artikelbezeichnung
246-082-008-015N	996.628.172.00	PORSCHE	246-082-008-025G	SWP-M-C
246-082-008-017	0001753V001000000	SMART (MCC)	246-082-008-025G	SWP-M-C
246-082-008-017	1J5 955 651	AUDI	246-082-008-025G	SWP-M-C
246-082-008-017	1J5 955 651	SEAT	246-082-008-025G	SWP-M-C
246-082-008-017	1J5 955 651	SKODA	246-082-008-025G	SWP-M-C
246-082-008-017	1J5 955 651	VOLKSWAGEN	246-082-008-025G	SWP-M-C
246-082-008-017	1T0 955 651	SKODA	246-082-008-025G	SWP-M-C
246-082-008-017	1T0 955 651	VOLKSWAGEN	246-082-008-025G	SWP-M-C
246-082-008-017	210 869 08 21	MERCEDES-BENZ	246-082-008-025G	SWP-M-C
246-082-008-017	67 12 8 362 154	BMW	246-082-008-025G	SWP-M-C
246-082-008-017	67 12 8 377 612	BMW	246-082-008-025G	SWP-M-C
246-082-008-017	996.628.172.00	PORSCHE	246-082-008-025G	SWP-M-C
246-082-008-018	90585761	OPEL	246-082-008-021G	SWP-M-C
246-082-008-018	90585761	VAUXHALL	246-082-008-021G	SWP-M-C
246-082-008-018	14 50 184	OPEL	246-082-008-021G	SWP-M-C
246-082-008-018	14 50 184	VAUXHALL	246-082-008-021G	SWP-M-C
246-082-008-018	1H5 955 651	SEAT	246-082-008-021G	SWP-M-C
246-082-008-018	1H5 955 651	VOLKSWAGEN	246-082-008-021G	SWP-M-C
246-082-008-019	0001753V001000000	SMART (MCC)	246-082-008-025G	SWP-M-C
246-082-008-019	1J5 955 651	AUDI	246-082-008-025G	SWP-M-C
246-082-008-019	1J5 955 651	SEAT	246-082-008-025G	SWP-M-C
246-082-008-019	1J5 955 651	SKODA	246-082-008-025G	SWP-M-C
246-082-008-019	1J5 955 651	VOLKSWAGEN	246-082-008-025G	SWP-M-C
246-082-008-019	1T0 955 651	SKODA	246-082-008-025G	SWP-M-C
246-082-008-019	1T0 955 651	VOLKSWAGEN	246-082-008-025G	SWP-M-C
246-082-008-019	210 869 08 21	MERCEDES-BENZ	246-082-008-025G	SWP-M-C
246-082-008-019	67 12 8 362 154	BMW	246-082-008-025G	SWP-M-C
246-082-008-019	67 12 8 377 612	BMW	246-082-008-025G	SWP-M-C
246-082-008-019	996.628.172.00	PORSCHE	246-082-008-025G	SWP-M-C
246-082-008-021G	90585761	OPEL		SWP-M-C
246-082-008-021G	90585761	VAUXHALL		SWP-M-C
246-082-008-021G	14 50 184	OPEL		SWP-M-C
246-082-008-021G	14 50 184	VAUXHALL		SWP-M-C
246-082-008-021G	1H5 955 651	SEAT		SWP-M-C
246-082-008-021G	1H5 955 651	VOLKSWAGEN		SWP-M-C
246-082-008-022	0001753V001000000	SMART (MCC)	246-082-008-025G	SWP-M-C
246-082-008-022	1J5 955 651	AUDI	246-082-008-025G	SWP-M-C
246-082-008-022	1J5 955 651	SEAT	246-082-008-025G	SWP-M-C
246-082-008-022	1J5 955 651	SKODA	246-082-008-025G	SWP-M-C
246-082-008-022	1J5 955 651	VOLKSWAGEN	246-082-008-025G	SWP-M-C
246-082-008-022	1T0 955 651	SKODA	246-082-008-025G	SWP-M-C
246-082-008-022	1T0 955 651	VOLKSWAGEN	246-082-008-025G	SWP-M-C
246-082-008-022	210 869 08 21	MERCEDES-BENZ	246-082-008-025G	SWP-M-C
246-082-008-022	67 12 8 362 154	BMW	246-082-008-025G	SWP-M-C
246-082-008-022	67 12 8 377 612	BMW	246-082-008-025G	SWP-M-C
246-082-008-022	996.628.172.00	PORSCHE	246-082-008-025G	SWP-M-C
246-082-008-025G	0001753V001000000	SMART (MCC)		SWP-M-C
246-082-008-025G	1J5 955 651	AUDI		SWP-M-C
246-082-008-025G	1J5 955 651	SEAT		SWP-M-C



Artikel Nr.	OE Nr.	Hersteller	Artikel Nr. (neu)	Artikelbezeichnung
246-082-008-025G	1J5 955 651	SKODA		SWP-M-C
246-082-008-025G	1J5 955 651	VOLKSWAGEN		SWP-M-C
246-082-008-025G	1T0 955 651	SKODA		SWP-M-C
246-082-008-025G	1T0 955 651	VOLKSWAGEN		SWP-M-C
246-082-008-025G	210 869 08 21	MERCEDES-BENZ		SWP-M-C
246-082-008-025G	67 12 8 362 154	BMW		SWP-M-C
246-082-008-025G	67 12 8 377 612	BMW		SWP-M-C
246-082-008-025G	996.628.172.00	PORSCHE		SWP-M-C
246-082-008-026	0001753V001000000	SMART (MCC)	246-082-008-025G	SWP-M-C
246-082-008-026	1J5 955 651	AUDI	246-082-008-025G	SWP-M-C
246-082-008-026	1J5 955 651	SEAT	246-082-008-025G	SWP-M-C
246-082-008-026	1J5 955 651	SKODA	246-082-008-025G	SWP-M-C
246-082-008-026	1J5 955 651	VOLKSWAGEN	246-082-008-025G	SWP-M-C
246-082-008-026	1T0 955 651	SKODA	246-082-008-025G	SWP-M-C
246-082-008-026	1T0 955 651	VOLKSWAGEN	246-082-008-025G	SWP-M-C
246-082-008-026	210 869 08 21	MERCEDES-BENZ	246-082-008-025G	SWP-M-C
246-082-008-026	67 12 8 362 154	BMW	246-082-008-025G	SWP-M-C
246-082-008-026	67 12 8 377 612	BMW	246-082-008-025G	SWP-M-C
246-082-008-026	996.628.172.00	PORSCHE	246-082-008-025G	SWP-M-C
246-083-001-001	0046797755	ALFA ROMEO	246-083-001-004C	SWP-D-C
246-083-001-001	0046797755	FIAT	246-083-001-004C	SWP-D-C
246-083-001-001	0046797755	LANCIA	246-083-001-004C	SWP-D-C
246-083-001-001	0071719636	ALFA ROMEO	246-083-001-004C	SWP-D-C
246-083-001-001	0071719636	FIAT	246-083-001-004C	SWP-D-C
246-083-001-001	0071719636	LANCIA	246-083-001-004C	SWP-D-C
246-083-001-001	90226604	OPEL	246-083-001-004C	SWP-D-C
246-083-001-001	90492357	VAUXHALL	246-083-001-004C	SWP-D-C
246-083-001-001	14 50 175	OPEL	246-083-001-004C	SWP-D-C
246-083-001-001	14 50 175	VAUXHALL	246-083-001-004C	SWP-D-C
246-083-001-002	333 955 651	VOLKSWAGEN	246-083-002-006G	SWP-D-C
246-083-001-002	81.26485-6027	MAN	246-083-002-006G	SWP-D-C
246-083-001-004C	0046797755	ALFA ROMEO		SWP-D-C
246-083-001-004C	0046797755	FIAT		SWP-D-C
246-083-001-004C	0046797755	LANCIA		SWP-D-C
246-083-001-004C	0071719636	ALFA ROMEO		SWP-D-C
246-083-001-004C	0071719636	FIAT		SWP-D-C
246-083-001-004C	0071719636	LANCIA		SWP-D-C
246-083-001-004C	90226604	OPEL		SWP-D-C
246-083-001-004C	90492357	VAUXHALL		SWP-D-C
246-083-001-004C	14 50 175	OPEL		SWP-D-C
246-083-001-004C	14 50 175	VAUXHALL		SWP-D-C
246-083-001-006C	81.26485-6027	MAN		SWP-D-C
246-083-002-001Z	7222079	FORD	246-083-002-014G	SWP-D-C
246-083-002-001Z	90585762	OPEL	246-083-002-014G	SWP-D-C
246-083-002-001Z	90585762	VAUXHALL	246-083-002-014G	SWP-D-C
246-083-002-001Z	14 50 185	OPEL	246-083-002-014G	SWP-D-C
246-083-002-001Z	14 50 185	VAUXHALL	246-083-002-014G	SWP-D-C
246-083-002-001Z	1H6 955 651	SEAT	246-083-002-014G	SWP-D-C
246-083-002-001Z	1H6 955 651	VOLKSWAGEN	246-083-002-014G	SWP-D-C



Artikel Nr.	OE Nr.	Hersteller	Artikel Nr. (neu)	Artikelbezeichnung
246-083-002-001Z	95VW-17K624-AA	FORD	246-083-002-014G	SWP-D-C
246-083-002-002C	333 955 651	VOLKSWAGEN	246-083-002-006G	SWP-D-C
246-083-002-002C	81.26485-6027	MAN	246-083-002-006G	SWP-D-C
246-083-002-005C	0000038V001000000	SMART (MCC)	246-083-002-022G	SWP-D-C
246-083-002-005C	1J6 955 651	AUDI	246-083-002-022G	SWP-D-C
246-083-002-005C	1J6 955 651	SEAT	246-083-002-022G	SWP-D-C
246-083-002-005C	1J6 955 651	SKODA	246-083-002-022G	SWP-D-C
246-083-002-005C	1J6 955 651	VOLKSWAGEN	246-083-002-022G	SWP-D-C
246-083-002-005C	1T0 955 651 A	AUDI	246-083-002-022G	SWP-D-C
246-083-002-005C	1T0 955 651 A	SEAT	246-083-002-022G	SWP-D-C
246-083-002-005C	1T0 955 651 A	SKODA	246-083-002-022G	SWP-D-C
246-083-002-005C	1T0 955 651 A	VOLKSWAGEN	246-083-002-022G	SWP-D-C
246-083-002-005C	67 12 8 377 987	BMW	246-083-002-022G	SWP-D-C
246-083-002-006G	333 955 651	VOLKSWAGEN		SWP-D-C
246-083-002-007	7222079	FORD	246-083-002-014G	SWP-D-C
246-083-002-007	90585762	OPEL	246-083-002-014G	SWP-D-C
246-083-002-007	90585762	VAUXHALL	246-083-002-014G	SWP-D-C
246-083-002-007	14 50 185	OPEL	246-083-002-014G	SWP-D-C
246-083-002-007	14 50 185	VAUXHALL	246-083-002-014G	SWP-D-C
246-083-002-007	1H6 955 651	SEAT	246-083-002-014G	SWP-D-C
246-083-002-007	1H6 955 651	VOLKSWAGEN	246-083-002-014G	SWP-D-C
246-083-002-007	95VW-17K624-AA	FORD	246-083-002-014G	SWP-D-C
246-083-002-008	7222079	FORD	246-083-002-014G	SWP-D-C
246-083-002-008	90585762	OPEL	246-083-002-014G	SWP-D-C
246-083-002-008	90585762	VAUXHALL	246-083-002-014G	SWP-D-C
246-083-002-008	14 50 185	OPEL	246-083-002-014G	SWP-D-C
246-083-002-008	14 50 185	VAUXHALL	246-083-002-014G	SWP-D-C
246-083-002-008	1H6 955 651	SEAT	246-083-002-014G	SWP-D-C
246-083-002-008	1H6 955 651	VOLKSWAGEN	246-083-002-014G	SWP-D-C
246-083-002-008	95VW-17K624-AA	FORD	246-083-002-014G	SWP-D-C
246-083-002-009	0000038V001000000	SMART (MCC)	246-083-002-022G	SWP-D-C
246-083-002-009	1J6 955 651	AUDI	246-083-002-022G	SWP-D-C
246-083-002-009	1J6 955 651	SEAT	246-083-002-022G	SWP-D-C
246-083-002-009	1J6 955 651	SKODA	246-083-002-022G	SWP-D-C
246-083-002-009	1J6 955 651	VOLKSWAGEN	246-083-002-022G	SWP-D-C
246-083-002-009	1T0 955 651 A	AUDI	246-083-002-022G	SWP-D-C
246-083-002-009	1T0 955 651 A	SEAT	246-083-002-022G	SWP-D-C
246-083-002-009	1T0 955 651 A	SKODA	246-083-002-022G	SWP-D-C
246-083-002-009	1T0 955 651 A	VOLKSWAGEN	246-083-002-022G	SWP-D-C
246-083-002-009	67 12 8 377 987	BMW	246-083-002-022G	SWP-D-C
246-083-002-010	0000038V001000000	SMART (MCC)	246-083-002-022G	SWP-D-C
246-083-002-010	1J6 955 651	AUDI	246-083-002-022G	SWP-D-C
246-083-002-010	1J6 955 651	SEAT	246-083-002-022G	SWP-D-C
246-083-002-010	1J6 955 651	SKODA	246-083-002-022G	SWP-D-C
246-083-002-010	1J6 955 651	VOLKSWAGEN	246-083-002-022G	SWP-D-C
246-083-002-010	1T0 955 651 A	AUDI	246-083-002-022G	SWP-D-C
246-083-002-010	1T0 955 651 A	SEAT	246-083-002-022G	SWP-D-C
246-083-002-010	1T0 955 651 A	SKODA	246-083-002-022G	SWP-D-C
246-083-002-010	1T0 955 651 A	VOLKSWAGEN	246-083-002-022G	SWP-D-C



Artikel Nr.	OE Nr.	Hersteller	Artikel Nr. (neu)	Artikelbezeichnung
246-083-002-010	67 12 8 377 987	BMW	246-083-002-022G	SWP-D-C
246-083-002-012G	7222079	FORD	246-083-002-014G	SWP-D-C
246-083-002-012G	90585762	OPEL	246-083-002-014G	SWP-D-C
246-083-002-012G	90585762	VAUXHALL	246-083-002-014G	SWP-D-C
246-083-002-012G	14 50 185	OPEL	246-083-002-014G	SWP-D-C
246-083-002-012G	14 50 185	VAUXHALL	246-083-002-014G	SWP-D-C
246-083-002-012G	1H6 955 651	SEAT	246-083-002-014G	SWP-D-C
246-083-002-012G	1H6 955 651	VOLKSWAGEN	246-083-002-014G	SWP-D-C
246-083-002-012G	95VW-17K624-AA	FORD		SWP-D-C
246-083-002-014G	7222079	FORD		SWP-D-C
246-083-002-014G	90585762	OPEL		SWP-D-C
246-083-002-014G	90585762	VAUXHALL		SWP-D-C
246-083-002-014G	14 50 185	OPEL		SWP-D-C
246-083-002-014G	14 50 185	VAUXHALL		SWP-D-C
246-083-002-014G	1H6 955 651	SEAT		SWP-D-C
246-083-002-014G	1H6 955 651	VOLKSWAGEN		SWP-D-C
246-083-002-014G	95VW-17K624-AA	FORD		SWP-D-C
246-083-002-015	0000038V001000000	SMART (MCC)	246-083-002-022G	SWP-D-C
246-083-002-015	1J6 955 651	AUDI	246-083-002-022G	SWP-D-C
246-083-002-015	1J6 955 651	SEAT	246-083-002-022G	SWP-D-C
246-083-002-015	1J6 955 651	SKODA	246-083-002-022G	SWP-D-C
246-083-002-015	1J6 955 651	VOLKSWAGEN	246-083-002-022G	SWP-D-C
246-083-002-015	1T0 955 651 A	AUDI	246-083-002-022G	SWP-D-C
246-083-002-015	1T0 955 651 A	SEAT	246-083-002-022G	SWP-D-C
246-083-002-015	1T0 955 651 A	SKODA	246-083-002-022G	SWP-D-C
246-083-002-015	1T0 955 651 A	VOLKSWAGEN	246-083-002-022G	SWP-D-C
246-083-002-015	67 12 8 377 987	BMW	246-083-002-022G	SWP-D-C
246-083-002-019	0000038V001000000	SMART (MCC)	246-083-002-022G	SWP-D-C
246-083-002-019	1J6 955 651	AUDI	246-083-002-022G	SWP-D-C
246-083-002-019	1J6 955 651	SEAT	246-083-002-022G	SWP-D-C
246-083-002-019	1J6 955 651	SKODA	246-083-002-022G	SWP-D-C
246-083-002-019	1J6 955 651	VOLKSWAGEN	246-083-002-022G	SWP-D-C
246-083-002-019	1T0 955 651 A	AUDI	246-083-002-022G	SWP-D-C
246-083-002-019	1T0 955 651 A	SEAT	246-083-002-022G	SWP-D-C
246-083-002-019	1T0 955 651 A	SKODA	246-083-002-022G	SWP-D-C
246-083-002-019	1T0 955 651 A	VOLKSWAGEN	246-083-002-022G	SWP-D-C
246-083-002-019	67 12 8 377 987	BMW	246-083-002-022G	SWP-D-C
246-083-002-022G	0000038V001000000	SMART (MCC)		SWP-D-C
246-083-002-022G	1J6 955 651	AUDI		SWP-D-C
246-083-002-022G	1J6 955 651	SEAT		SWP-D-C
246-083-002-022G	1J6 955 651	SKODA		SWP-D-C
246-083-002-022G	1J6 955 651	VOLKSWAGEN		SWP-D-C
246-083-002-022G	1T0 955 651 A	AUDI		SWP-D-C
246-083-002-022G	1T0 955 651 A	SEAT		SWP-D-C
246-083-002-022G	1T0 955 651 A	SKODA		SWP-D-C
246-083-002-022G	1T0 955 651 A	VOLKSWAGEN	246-083-002-022G	SWP-D-C
246-083-002-022G	67 12 8 377 987	BMW		SWP-D-C
246-086-001-002C	191 955 681	VOLKSWAGEN		HLWP
246-086-001-002C	1J0 955 681	AUDI		HLWP



Artikel Nr.	OE Nr.	Hersteller	Artikel Nr. (neu)	Artikelbezeichnung
246-086-001-002C	1J0 955 681	SEAT		HLWP
246-086-001-002C	1J0 955 681	SKODA		HLWP
246-086-001-002C	3B0 955 681	VOLKSWAGEN		HLWP
246-086-001-002C	996.624.502.00	PORSCHE		HLWP
246-086-001-002C	MR911031	MITSUBISHI		HLWP
246-086-001-004	3B0 955 681 A	SKODA	246-086-001-007C	HLWP
246-086-001-004	3B0 955 681 A	VOLKSWAGEN	246-086-001-007C	HLWP
246-086-001-004	3B7 955 681	AUDI	246-086-001-007C	HLWP
246-086-001-004	3B7 955 681	SEAT	246-086-001-007C	HLWP
246-086-001-004	3B7 955 681	SKODA	246-086-001-007C	HLWP
246-086-001-004	3B7 955 681	VOLKSWAGEN	246-086-001-007C	HLWP
246-086-001-004	67 12 8 377 430	BMW	246-086-001-007C	HLWP
246-086-001-004	67 12 8 377 613	BMW	246-086-001-007C	HLWP
246-086-001-005	191 955 681	VOLKSWAGEN	246-086-001-002C	HLWP
246-086-001-005	1J0 955 681	AUDI	246-086-001-002C	HLWP
246-086-001-005	1J0 955 681	SEAT	246-086-001-002C	HLWP
246-086-001-005	1J0 955 681	SKODA	246-086-001-002C	HLWP
246-086-001-005	3B0 955 681	VOLKSWAGEN	246-086-001-002C	HLWP
246-086-001-005	996.624.502.00	PORSCHE	246-086-001-002C	HLWP
246-086-001-005	MR911031	MITSUBISHI	246-086-001-002C	HLWP
246-086-001-006	191 955 681	VOLKSWAGEN	246-086-001-002C	HLWP
246-086-001-006	1J0 955 681	AUDI	246-086-001-002C	HLWP
246-086-001-006	1J0 955 681	SEAT	246-086-001-002C	HLWP
246-086-001-006	1J0 955 681	SKODA	246-086-001-002C	HLWP
246-086-001-006	3B0 955 681	VOLKSWAGEN	246-086-001-002C	HLWP
246-086-001-006	996.624.502.00	PORSCHE	246-086-001-002C	HLWP
246-086-001-006	MR911031	MITSUBISHI	246-086-001-002C	HLWP
246-086-001-007C	3B0 955 681 A	SKODA		HLWP
246-086-001-007C	3B0 955 681 A	SKODA	246-086-001-007C	HLWP
246-086-001-007C	3B0 955 681 A	VOLKSWAGEN		HLWP
246-086-001-007C	3B0 955 681 A	VOLKSWAGEN	246-086-001-007C	HLWP
246-086-001-007C	3B7 955 681	AUDI		HLWP
246-086-001-007C	3B7 955 681	SEAT		HLWP
246-086-001-007C	3B7 955 681	SEAT	246-086-001-007C	HLWP
246-086-001-007C	3B7 955 681	SKODA		HLWP
246-086-001-007C	3B7 955 681	SKODA	246-086-001-007C	HLWP
246-086-001-007C	3B7 955 681	VOLKSWAGEN		HLWP
246-086-001-007C	3B7 955 681	VOLKSWAGEN	246-086-001-007C	HLWP
246-086-001-007C	67 12 8 377 430	BMW		HLWP
246-086-001-007C	67 12 8 377 613	BMW		HLWP
246-086-001-016	3B0 955 681 A	SKODA	246-086-001-007C	HLWP
246-086-001-016	3B0 955 681 A	VOLKSWAGEN	246-086-001-007C	HLWP
246-086-001-016	3B7 955 681	AUDI	246-086-001-007C	HLWP
246-086-001-016	3B7 955 681	SEAT	246-086-001-007C	HLWP
246-086-001-016	3B7 955 681	SKODA	246-086-001-007C	HLWP
246-086-001-016	3B7 955 681	VOLKSWAGEN	246-086-001-007C	HLWP
246-086-001-016	67 12 8 377 430	BMW	246-086-001-007C	HLWP
246-086-001-016	67 12 8 377 613	BMW	246-086-001-007C	HLWP
395-060-017-001C	61 31 1 369 263	BMW		FLS



Artikel Nr.	OE Nr.	Hersteller	Artikel Nr. (neu)	Artikelbezeichnung
395-060-017-002C				FLS
395-060-025-001C				FLS
88-205-001	000 869 01 58	MERCEDES-BENZ		C
88-243-005				C
88-267-012				C
88-326-001	61 66 1 350 885	BMW		C
88-326-001	81.26483-0001	MAN		C
88-326-004	107 869 00 24	MERCEDES-BENZ		C
89-602-050	81.26481-0033	MAN		G
X10-729-002-004	1652613	FORD		SWP-M-C
X10-729-002-004	7003178	FORD		SWP-M-C
X10-729-002-004	1E00 76 672	MAZDA		SWP-M-C
X10-729-002-004	87AB-17K624-AC	FORD		SWP-M-C
X10-729-002-004	93BB-17K624-BA	FORD		SWP-M-C
X10-729-002-005	6833495	FORD		SWP-M-C
X10-729-002-005	7003177	FORD		SWP-M-C
X10-729-002-005	92AB-17K624-AA	FORD		SWP-M-C
X10-729-002-005	93BB-17K624-AA	FORD		SWP-M-C
X10-729-002-006	7700802336	RENAULT		SWP-M-C
X10-729-002-007	0000643458	CITROEN		SWP-M-C
X10-729-002-007	643458	PEUGEOT		SWP-M-C
X10-729-002-008	6140949	FORD		SWP-M-C
X10-729-002-008	83BB-17K624-BA	FORD		SWP-M-C
X11-246-000-001				V
X11-246-003-013				A
X11-246-003-014	1J0 973 722 A	AUDI		A
X11-246-003-014	1J0 973 722 A	SEAT		A
X11-246-003-014	1J0 973 722 A	SKODA		A
X11-246-003-014	1J0 973 722 A	VOLKSWAGEN		A

Abbildungen Pumpenhalter

Die Halter finden auch bei Scheiben-Reinigungspumpen mit anderen als den abgebildeten Steckern Verwendung.

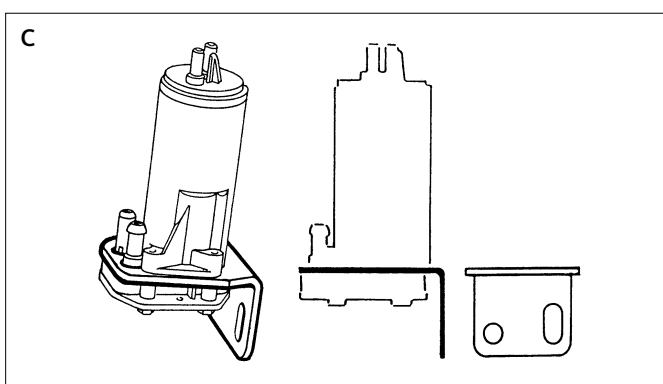
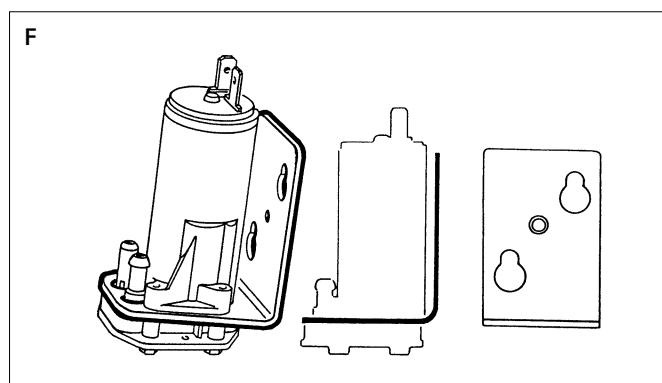
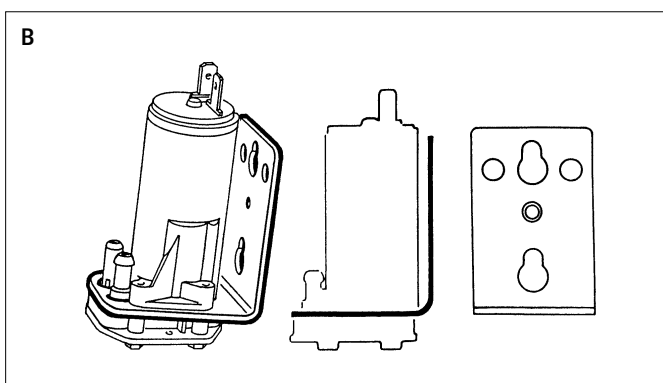
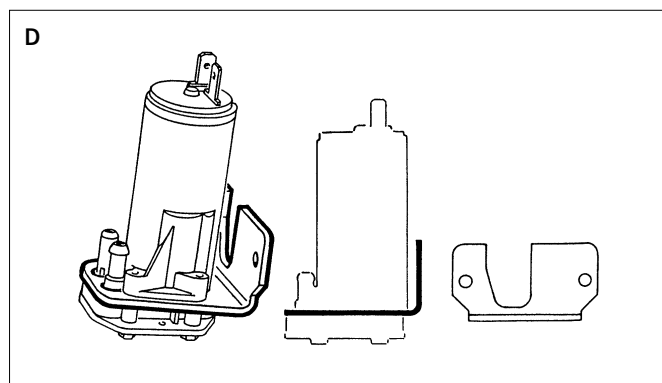
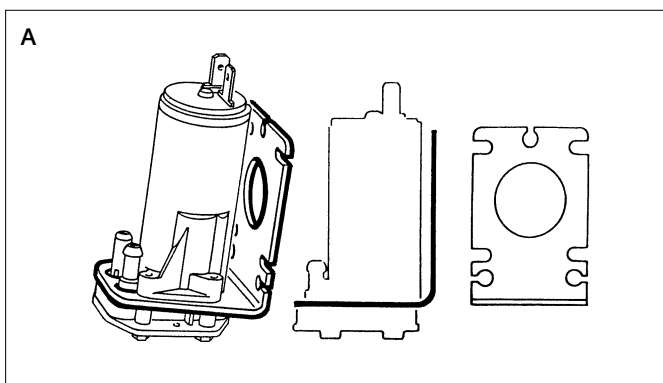

Abbildungen Pumpenstecker

Bitte achten Sie beim Anschluss der Pumpen auf die korrekte Polung (+/-).

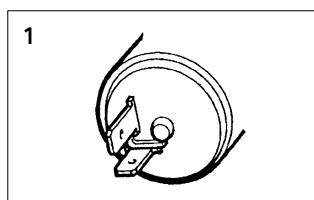

1 ALFA ROMEO, AUDI, BMW, FIAT, FORD, LADA, LANCIA, MAN, MERCEDES-BENZ, OPEL, PORSCHE, SAAB, SEAT, VAUXHALL, VOLKSWAGEN, VOLVO

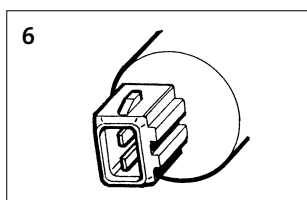

6 FORD, OPEL, SEAT, VAUXHALL, VOLKSWAGEN

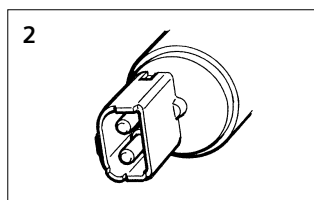

2 SAAB, SCANIA, VOLVO

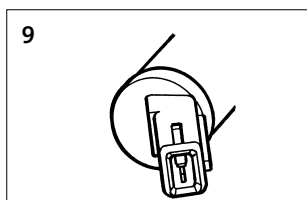

9 FORD, MAZDA

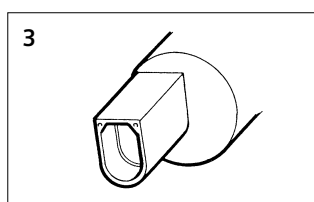

3 AUDI, BMW, MERCEDES-BENZ, MITSUBISHI, PORSCHE, SEAT, SKODA, SMART (MCC), VOLKSWAGEN

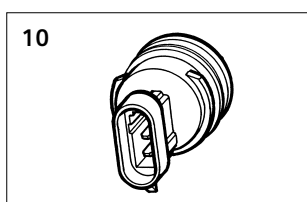

10 RENAULT

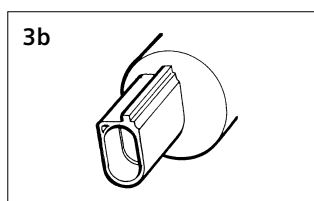

3b AUDI, BMW, MERCEDES-BENZ, SEAT, SKODA, VOLKSWAGEN

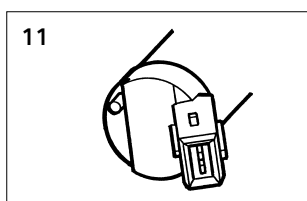

11 CITROËN, PEUGEOT

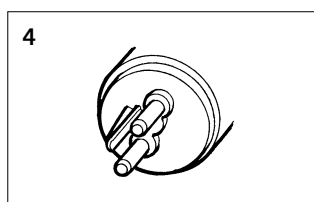

4 MERCEDES-BENZ

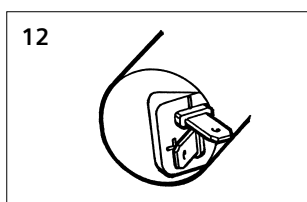

12 FORD

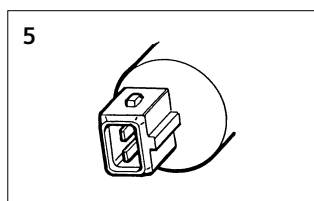

5 VOLVO

Abkürzung	Beschreibung
SWP-M-C	Scheiben-Reinigungspumpe, Mono – Zentrifugalpumpe
SWP-M-G	Scheiben-Reinigungspumpe, Mono – Zahnradpumpe
SWP-D-C	Scheiben-Reinigungspumpe, Dual – Zentrifugalpumpe
HLWP	Scheinwerfer-Reinigungspumpe
N	Düse
N-H	Düse, heizbar
FLS	Niveauschalter
C	Verbindungsstück
V	Ventil
G	Dichtung
NN	Düsennadel
A	Adapter
R	Behälter
T1: ...	Pumpenstecker Nr.: ...
T2: ...	Pumpenhalter Nr.: ...
T3: ...	Erforderliches Teil: ...
T4	Hinten verbaut
T5: ...	Türanzahl: ...
T6: ...	Einschränkung (Hersteller): ...
T7: ...	Fahrzeugausstattung: ... 501
T8	Für Fahrzeuge mit Heckscheibenwischer
T9	Für Fahrzeuge mit Scheinwerferreinigungsanlage
T10	Für Fahrzeuge mit Klimaanlage
T11	Für Fahrzeuge ohne Klimaanlage
T12	Für Fahrzeuge mit Servolenkung
T13	Für OE Nummer: ...
T14	Für Rechtslenker

Catalogues

- Stellelemente für Zentralverriegelungen
- Motormanagement
- Kraftstoffsysteme
- Gebläse- und Lüftersysteme
- Sensoren für Motormanagement
- Sensoren für Instrumentierung

TecDoc CATALOG (DVD) TecDoc WEB CATALOG

- Electronic Automotive Parts Catalogue
Information | Order
TecDoc Informations System GmbH
Ostmerheimer Strasse 198
51109 Cologne
Germany
Tel.: +49 (221) 66 00-224
Fax: +49 (221) 66 00-100
E-mail: tecdoc@tecdoc.net
Internet: www.tecdoc.net



Continental is a certified
TecDoc partner.

Internet

- www.vdo.com

Continental Trading GmbH

Ludwig-Erhard-Strasse 28

65760 Eschborn

Telefon: 06196-5319-0

www.vdo.de

E-Mail: replacementparts@vdo.com

VDO - A Trademark of the Continental Corporation

Die Informationen in dieser Broschüre enthalten lediglich allgemeine Beschreibungen bzw. Leistungsmerkmale, die im konkreten Anwendungsfall nicht immer in der beschriebenen Form zutreffen bzw. die sich durch Weiterentwicklung der Produkte ändern können. Bei diesen Informationen handelt es sich lediglich um eine technische Beschreibung des Produkts. Sie stellen insbesondere keine Beschaffenheits- oder Haltbarkeitsgarantie dar. Die gewünschten Leistungsmerkmale sind nur dann verbindlich, wenn sie bei Vertragsabschluss ausdrücklich vereinbart werden. Liefermöglichkeiten und technische Änderungen vorbehalten.

Continental Trading GmbH © 2009

VDO